



# BOSTON REGION METROPOLITAN PLANNING ORGANIZATION

Richard A. Davey, MassDOT Secretary and CEO and MPO Chairman  
Karl H. Quackenbush, Executive Director, MPO Staff

## MEMORANDUM

**DATE:** October 17, 2013  
**TO:** Boston Region Metropolitan Planning Organization  
**FROM:** Seth Asante, MPO Staff  
**RE:** Route 30 Arterial Segment Study in Framingham and Natick

### 1 EXECUTIVE SUMMARY

The Long-Range Transportation Plan (LRTP) identified Route 30 in Framingham and Natick as one of the priority arterial segments in need of maintenance, modernization, safety, and mobility improvements. The arterial segment of Route 30 from Ring Road in Framingham to the TJX Companies driveway in Natick was selected for study because MassDOT and the Towns of Framingham and Natick cited serious mobility and safety issues for pedestrians, bicycles, and motorists in the segment, as well as congestion. An advisory task force composed of representatives from MassDOT and the Towns of Framingham and Natick was established to participate in this study. MPO staff met with the task force two times: once to discuss the work scope and finalize the existing conditions and problems, and another time to present improvement recommendations for comments. The purposes of this study were to inventory existing problems in the arterial segment under study and develop transportation improvements to address those problems.

This memorandum is organized into seven sections: 1) executive summary, 2) background, 3) data collection, 4) existing conditions analyses, 5) future traffic growth, 6) recommended improvements, and 7) conclusions and next steps. Several types of data were collected in the field or obtained from other sources and used to evaluate the existing conditions—including data and information on operations, safety, mobility, and land use. The MassDOT Highway and Planning Division, Town of Framingham and Town of Natick provided most of the data used in this study.

#### 1.1 Existing Problems

1. Two of the five signalized intersections selected for study had a large number of crashes:
  - Route 30 at Whittier Street had 63 crashes between 2007 and 2012, although its intersection crash rate of 0.76 per million entering vehicles (MEV) was lower than the MassDOT Highway Division

District 3 average crash rate for signalized intersection, which is 0.89 MEV.

- Route 30 at Speen Street had 85 crashes between 2007 and 2012 and a crash rate of 0.70 MEV.

The prevalent crash types were rear-end and angle collisions caused by unexpected stops in reaction to the recurrent traffic queues and failure to yield right-of-way. Between 34 and 50 percent of total crashes occurred during peak periods<sup>1</sup>—when there are high traffic volumes and long queues in the corridor.

2. The segment of Route 30 west of Speen Street with a two-way left-turn lane (TWLTL), experiences a large number of crashes; this segment, approximately 300 feet long, had 22 crashes between 2007 and 2012. The majority crashes in this segment were of the angle type, involving motorists turning into or out of driveways. The primary contributing factors were failure to yield right-of-way and changing lanes.
3. There is poor mobility for pedestrians and bicyclists in the study area. The existing network of sidewalks has gaps in the vicinity of MassPike ramp-Route 30 junctions. Footprints in this area show some usage and the need to close this gap; and this need should become even more critical when the Cochituate Rail Trail (CRT) is completed.
4. There is lack of accommodations for bicyclists in the study area. Bicyclists need to share travel lanes with motorists, as there are no usable shoulders or bike lanes in the area; yet no signage or pavement markings have been provided to alert motorists to sharing the road.
5. High traffic demands during peak travel periods heading to and from the businesses in the study area and the MassPike create traffic capacity issues, especially at the Route 30 and Speen Street intersection. This is the most critical intersection in the arterial segment as its traffic queues affect traffic operations at other intersections, such as:
  - Route 30 and TJX Companies driveway intersection in Natick—where a police detail conducts traffic during the PM peak period to allow employees to exit the site
  - Route 30 and MassPike off-ramp that joins eastbound Route 30
  - Speen Street and Chrysler Road intersection in Natick
  - Speen Street and Leggat McCall Connector Road intersection in Framingham

---

<sup>1</sup> The AM peak period is 7:00 AM to 9:00 AM, and the PM peak period is 4:00 PM to 6:00 PM.

6. Traffic on the MassPike on-ramp near the Red Roof Inn occasionally backs up onto Route 30 westbound during the PM peak period. This condition has an impact on traffic operations at the Speen Street intersection by slowing traffic heading westbound on Route 30 and creating a queue that spills into the Speen Street intersection. This contributes to the congestion and queues at the intersection, especially Speen Street northbound and Route 30 westbound.
7. Delays, queues and congestion at the Route 30 and Speen Street intersection inhibit safe and free-flow access from and to commercial establishments. For example, although the intersection of the TJX driveway and Route 30 is signalized, a traffic surge because of employee traffic (5:00 PM to 5:45 PM) and high volume of traffic on Route 30, and a traffic queue on the Route 30 westbound approach require a police officer controls PM peak-hour traffic in order for employee traffic to exit safely.
8. Traffic on the side streets, Whittier Street southbound and Burr Street southbound, experience long delays and queues upon entering Route 30 during the PM peak period. The delays on these side streets are so significant that they are in the unacceptable level-of-service (LOS) range.
9. In the near future, a proposed Cochituate Rail Trail will cross busy Route 30 at the Framingham and Natick town line near the Speen Street intersection; and both communities are concerned about what types of crossings would ensure safety for all users in the vicinity of the new trail. There are operational and safety issues that need to be addressed for trail users such as: 1) trail crossings should follow pedestrian desire lines, 2) bicyclists should not have to walk their bikes to an intersection, 3) crossings should avoid busy driveways, and 4) crossings should avoid site conditions that pose risks for trail users, e.g., crossing busy Route 30 at-grade.

## 1.2 Proposed Improvements

### 1.2.1 *Pedestrian and Bicyclist Accommodation*

Because of the serious mobility and safety issues facing pedestrians and bicyclists in the arterial segment, MPO staff developed three options for addressing gaps in sidewalks on Route 30 in the vicinity of the MassPike, and for providing shared-use paths for bicyclists. Cost and effectiveness (i.e., safety for pedestrians and bicyclists) are the two primary factors for selecting a preferred alternative. The three options are:

- Option 1: Improving existing sidewalks on Burr Street and Leggat McCall Connector Road for accessing the Cochituate Rail Trail.
- Option 2: Constructing a new sidewalk on the south side of Route 30 in the vicinity of the MassPike connector ramps to provide a continuous sidewalk for accessing businesses near the Route 30 and Speen Street intersection and the Cochituate Rail Trail.
- Option 3: Constructing a new sidewalk and multiuse path around the outer loop of the MassPike connector south of Route 30 for accessing businesses near the Route 30 and Speen Street intersection and the Cochituate Rail Trail.

In addition, MPO staff suggests the following improvements to accommodate pedestrians and bicyclists.

- Adding buffers between the sidewalks and roadway curbs along Route 30 to provide protection and comfort for pedestrians.
- Installing shared-lane markings (sharrows) in the rightmost through lanes on Route 30 for bicyclists.
- Installing bicycle detectors and bicycle-detector pavement markings at the signalized intersections.

### **1.2.2 *Retime Traffic Signals***

Analysis and field observations identified three traffic signals that were operating unsatisfactorily during the peak periods. MPO staff recommends adjusting the existing traffic signal timings at the following intersections to improve traffic flow:

- Route 30 and Speen Street intersection, where the existing cycle length and phase splits need optimization for the AM and PM peak periods.
- Route 30 and Burr Street intersection, where the side street (Burr Street) experiences long delays during the PM peak period and the yellow change interval increased to four seconds from three seconds.
- Route 30 and Whittier Street intersection, where the side street (Whittier Street) experiences long delays during the PM peak period and the all-red interval increased to two seconds from one second.

### **1.2.3 *Safety Improvements in the Segment with Two-way Left-Turn Lane***

The segment of Route 30 with the two-way center left-turn lane had a large number of angle-type crashes involving motorists turning into or out of driveways (primary contributing factors attributed to failure to yield right-of-way



and changing lanes). MPO staff recommends the following safety improvements:

- The Town of Framingham should work with business owners to manage driveway spacing effectively in this segment by consolidating and sharing driveways.
- Or, the town should consider redeveloping the existing uses with improved access.
- Or, it should eliminate the two-way, left-turn lane in the segment, install a median, and restrict access/egress to business driveways to right-turn-in and right-turn out only.
- Finally, the town could add raised median to separate Route 30 eastbound left-turn lane from the westbound lanes, and to prevent motorists from using it to change lanes to head eastbound.

#### **1.2.4 *Medium- and Long-term Improvement Concepts for Route 30 and Speen Street Intersection***

Currently, the Route 30 and Speen Street intersection is operating at capacity during peak periods, and analysis shows that significant improvement in capacity resulting from traffic signal retiming is not anticipated. Peak period traffic demands at the intersection are so great that a traffic queue is created on each approach. In addition, wetlands and businesses adjacent to the intersection place constraints on further widening the space. An evaluation of traffic flow patterns indicated that on average about 70 percent of the traffic heading westbound on Route 30 just west of the Speen Street intersection proceeds to the MassPike. Based on this observation, MPO staff assumed that the majority of the high-volume northbound left-turn, southbound right-turn, and, to a lesser degree, westbound straight-through movements at the Speen Street intersection are destined to the MassPike.

##### **Medium-Term Improvement Concepts**

For a medium-term improvement at this location, MPO staff tested adding a traffic lane in the westbound direction of Route 30. The lane would start at the TJX driveway, cross Speen Street, and continue as a third lane between Speen Street and the I-90 on ramp, which would become a two-lane ramp.

Comparison of intersection delays and queues with and without the third lane showed a reduction in delay per vehicle of up to 25% and queue lengths of up to 40%. These estimates vary by traffic movement, approach, traffic signal design parameters, and peak hour.

Potential affects from adding a third westbound lane would be land takings, and reduced safety at access/egress points at business driveways along the Route

30 segment, where the widening would occur. To make this improvement work successfully, MPO staff recommends that the two-way left-turn lane in this segment be replaced with a raised median, and access/egress points to business driveways be restricted to right-turn-in and right-turn-out to improve safety.

### Long-Term Improvement Concepts

For long-term improvements, MPO staff developed five concepts for discussion, and the future consideration of Natick, Framingham, and MassDOT. These conceptual designs exhibit potential advantages and disadvantages regarding driveway access/egress, constructability, cost, environmental impacts, traffic operations, and other considerations. The five concepts are:

- Concept 1: Speen Street over Route 30 (northbound and southbound through movements)
- Concept 2: Grade-separated Speen Street northbound left turn and Route 30 eastbound exclusive double right-turn lanes
- Concept 3: Grade-separated median left turn from Speen Street northbound to MassPike (eastbound and westbound)
- Concept 4: Grade-separated median left-turn from Speen Street northbound to MassPike (eastbound only)
- Concept 5: Convert the south leg of Speen Street into a continuous-flow intersection

### 1.2.5 *Cochituate Rail-Trail Crossing at Route 30*

MPO staff analyzed four crossing alternatives to improve safety for trail users at the Route 30 crossing.

- Alternative 1: Trail users would cross Route 30 at the Speen Street intersection
- Alternative 2: Trail users would cross Route 30 at the TJX Companies driveway intersection
- Alternative 3: Trail users would cross Route 30 at the existing track alignment
- Alternative 4: Trail users would cross Route 30 at the existing track alignment using grade separation (overpass or underpass)

Cost and effectiveness (i.e., trail user safety) are the two primary factors for selecting the preferred option.

- Alternative 4 is the most effective, and it is recommended by MPO staff, but would be the most expensive to install. If Alternative 4 is considered, the grade separation must be accessible for use by bicyclists and people with disabilities and be of the appropriate height for trucks and other heavy vehicles to travel under it.
- Alternative 1 or 2 would require short-term and low-cost improvements (crosswalks and sidewalks) but they would not be effective. A potential difficulty with implementing Alternatives 1 and 2 is channeling trail users to an intersection to avoid unsafe midblock crossing. Both alternatives would increase delay for trail users, as they would be diverted from the trail to an intersection and back to the trail for a total distance of 700 feet to 1,150 feet. Both alternatives would interrupt Route 30 traffic; however, trail users crossing at the Speen Street intersection would present the worst impact on traffic operations.
- Alternative 3 would require short-term, medium-cost improvements. This alternative provides trail users with a direct crossing along the path of the trail. However, site conditions such as a long crosswalk, high traffic volumes, and traffic queues that could affect trail users' sight lines are some of the safety issues that make this alternative less effective compared to Alternative 4.

#### *1.2.6 Summary, Conclusions, and Next Steps*

The study of the Route 30 segment between the TJX driveway and the intersection at Ring Road/Shopper's World Way examined existing conditions and identified short- and long-term improvement concepts.

The main concerns in this segment relate to connections to the MassPike; peak hour delays and queues, especially at the Route 30/Speen Street intersection during the PM peak period; incomplete network for bicyclist and pedestrian circulation, including the crossing of the Cochituate Rail Trail at Route 30, east of Speen Street; and congestion and safety related to driveway access, including the TJX driveway.

The study identified three options for closing the gaps in the existing bicycle and pedestrian circulation, including recommendations for signs and markings; traffic signal retiming schemes at four signalized intersections; traffic management options for the Route 30 segment between Speen Street and the MassPike on ramp; and, six medium- and long-term concepts for reconfiguring the connection of Speen Street and Route 30 to the MassPike, including adding a westbound traffic lane to Route 30 from the TJX driveway to the I-90 connector.

Long-term improvements in the Route 30 study segment hinge on improved regional connections between the MassPike and the local network that serves

Framingham and Natick, and other municipalities. Examining the design and feasibility of various connection options of Route 30 and Speen Street to the MassPike is particularly timely. MassDOT is planning to remove the toll plazas throughout the MassPike and replace them with an automatic toll collection system, All Electronic Tolling (AET). Connection options to I-90 from Framingham and Natick should be designed to include the parameters and assumptions built into MassDOT's AET project.

## 2 BACKGROUND AND SCOPE

The arterial segment of Route 30 between Ring Road in Framingham and the TJX Companies driveway in Natick (Figure 1) was selected for study because the Boston Region MPO's Long-Range Transportation Plan identified Route 30 as one of the priority arterial segments in need of maintenance, modernization, safety and mobility improvements, transit-service enhancements, and modernization. Moreover, MassDOT's Highway Division District 3 cites serious mobility and safety issues for pedestrians, bicycles, and motorists in the segment. To help identify solutions for addressing problems in priority arterial segments, an arterial segment study was included in the federal fiscal year (FFY) 2013 Unified Planning Work Program (UPWP).<sup>2</sup>

An arterial segment study is usually a logical way to multimodal transportation needs in a corridor. Typically, an arterial segment study uses a holistic approach. It analyzes services, and makes associated recommendations within the roadway's right-of-way, taking into account the needs of all abutters and users—pedestrians, bicyclists, motorists, public-transportation users, and the like. Implementing the recommendations in this report would result in an improved roadway corridor; one where it is safe to cross the street; walk or cycle to shops and recreational areas; and one that is safer for motorists.

### 2.1 Study Purpose

The purposes of this study were to inventory existing problems in the arterial segment under study and develop multimodal transportation improvements to address those problems. MPO staff worked closely with an advisory task force composed of representatives from MassDOT and the Towns of Framingham and Natick. MPO staff met with the task force twice: once to discuss the work scope and finalize the existing conditions and problems, and another time to present the improvement recommendations for comments.

---

<sup>2</sup> Boston Region Metropolitan Planning Organization, Unified Planning Work Program, Federal Fiscal Year 2013, Endorsed by the Boston Region Metropolitan Planning Organization on June 28, 2012.





**FIGURE 1**  
Study Area





## 2.2 Organization

This memorandum is organized into seven sections: an executive summary and six sections. Section 2 gives a brief background of the study. Section 3 describes the data collection methods and sources while Section 4 presents the existing conditions analyses. Section 5 presents future traffic growth while Section 6 describes the future conditions and improvements. Section 7 is presents the study conclusions and next steps.

## 3 DATA COLLECTION

Several types of data were collected in the field or obtained from other sources and were used to evaluate the existing conditions—they include data and information on operations, safety, mobility, and land use.

### 3.1 Vehicle, Pedestrian, and Bicycle Counts

The MassDOT Highway Division's Traffic Data Collection collected turning-movement counts (TMCs) at the study intersections in November 2012, when schools were in session. The counts were conducted during weekday morning and evening peak travel periods. Heavy vehicles (with six or more tires), including school buses, transit buses, and trucks, were counted separately. Pedestrian and bicycle counts were conducted simultaneously with the TMCs. In addition, MassDOT Highway Division's Traffic Data Collection conducted automatic traffic recorder (ATR)<sup>3</sup> counts for the MassPike on- and off-ramps (see Appendix A).

### 3.2 Intersection Geometry and Traffic Signal Information

The town of Framingham provided existing signal timings, as-built traffic signal plans, and phase sequences of the study intersections. The signal timing plan and phase sequence for the intersection of Route 30 and the TJX Companies driveway were measured in the field. A field inventory of intersection geometrics, lane configurations, and pedestrian and bicyclists amenities were conducted for this study. (Traffic signal timing information and intersection geometrics are located in Appendix B.)

### 3.3 Crash Data

MPO staff used crash data—from January 2008 through December 2012—obtained from the Framingham Police Department and the Natick Police Department, along with data from MassDOT's Registry of Motor Vehicles.

---

<sup>3</sup> ATR counts are 24-hour counts conducted at a location for two or more consecutive days.

### 3.4 Land Use and Development

The towns of Framingham and Natick provided information on land use, proposed developments, mitigation actions, and improvements.

## 4 EXISTING CONDITIONS EVALUATION

### 4.1 Roadway

The arterial segment of Route 30 under study is functionally classified as a principal arterial roadway. It is town owned and generally runs in an east-west direction (Figure 1). In Framingham, Route 30 is called Cochituate Road and it has two 11-foot travel lanes in each direction, with wider exclusive turn lanes at the signalized intersections. The segment just west of Speen Street has a 300-foot long two-way, left-turn lane. In Natick, Route 30 is called Commonwealth Road and it has an 11-foot travel lane in each direction with wider turn lanes at its intersection with TJX Companies driveway. There is no shoulder or bicycle lane in the study segment. The posted speed limit is generally 40 miles per hour (mph) in the Framingham segment and 35 mph in the Natick segment. There are sidewalks on both sides of Route 30 for most part of the segment under study; however, major gaps exist in sidewalks in the vicinity of the MassPike. There are five signalized intersections in the segment; four of which are under the jurisdiction of Framingham, and one located at the TJX Companies driveway, which is under the jurisdiction of Natick.

### 4.2 Intersections

#### 4.2.1 *Route 30 at TJX Companies Driveway*

Route 30 intersects the TJX Companies driveway to form a T-intersection. At the intersection, Route 30 provides one through travel lane in each direction, an exclusive left-turn lane on the eastbound approach, and an exclusive right-turn lane on the westbound approach. The TJX Companies driveway has exclusive right-turn and left-turn lanes. The intersection curb radii are adequate for truck traffic. Although the intersection



Route 30 at TJX Companies Driveway

has a fully actuated traffic signal with pedestrian signals and pushbuttons, a police detail conducts traffic at the intersection during the PM peak hour to assist employees exiting from the driveway onto Route 30 because of a recurrent traffic queue that blocks the intersection. In addition, there are documented concerns expressed by TJX that its business lacks good access to Route 30 and I-90 because of congestion through Speen Street and beyond. There is a crosswalk on the west leg of the intersection. The land use in the vicinity of the intersection is commercial and recreational—with Cochituate State Park located on the south side of Route 30.

#### 4.2.2 *Route 30 at Speen Street*

Route 30 intersects Speen Street to form a four-leg signalized intersection. The eastbound Route 30 approach has four lanes (exclusive left-turn lane, through lane, shared through/right-turn lane, and exclusive right-turn lane), while the westbound approach has three lanes (exclusive left-turn lane, through lane, shared through/right-turn lane). The Speen Street southbound approach has four lanes (exclusive left-turn lane, two through lanes, and exclusive



Route 30 at Speen Street

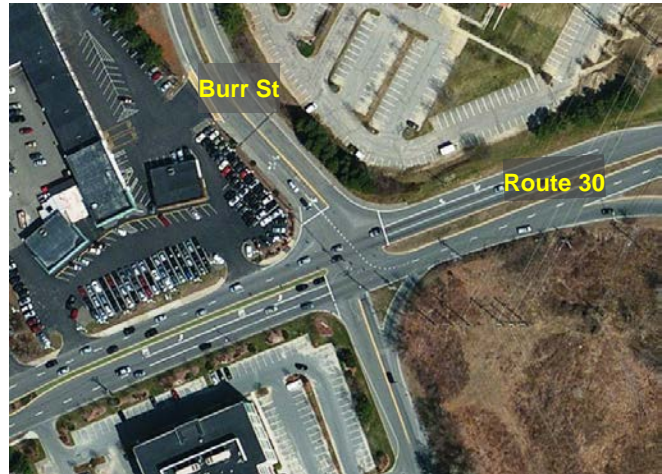
right-turn lane), while the northbound approach consists of four lanes (exclusive double left-turn lanes, through lane, and shared through/right-turn lane). The intersection curb radii are adequate for truck traffic. The intersection has a fully actuated traffic signal with pedestrian signals and pushbuttons and an emergency preemption system; but it is not coordinated with other Route 30 or Speen Street intersections because the MassPike traffic disrupts platoon progression on Route 30. There are no sidewalks on Route 30 or Speen Street in the southwest quadrant of the intersection and the east and north legs of the intersection lack crosswalks. The land use in the vicinity is commercial.

#### 4.2.3 *Route 30 at Burr Street*

Route 30 intersects Burr Street to form a four-leg intersection. The Route 30 eastbound approach consists of three travel lanes (exclusive left-turn lane, through lane, and shared through/right-turn lane). The westbound approach has three lanes (two through lanes and an exclusive right-turn lane). The Burr



Street southbound approach consists of two lanes (exclusive left turn lane and shared left/through/right lane), while the northbound approach consists of two lanes (shared left/through lane and channelized right turn lane). The intersection curb radii are adequate for truck traffic. The intersection has a fully actuated and coordinated traffic signal with an emergency vehicle preemption system. The sidewalks on Route 30 terminate at the intersection, which lacks crosswalk and pedestrian signals. The land use in the vicinity is commercial.



Route 30 at Burr Street

#### 4.2.4 *Route 30 at Whittier Street/Shopper's World Drive*

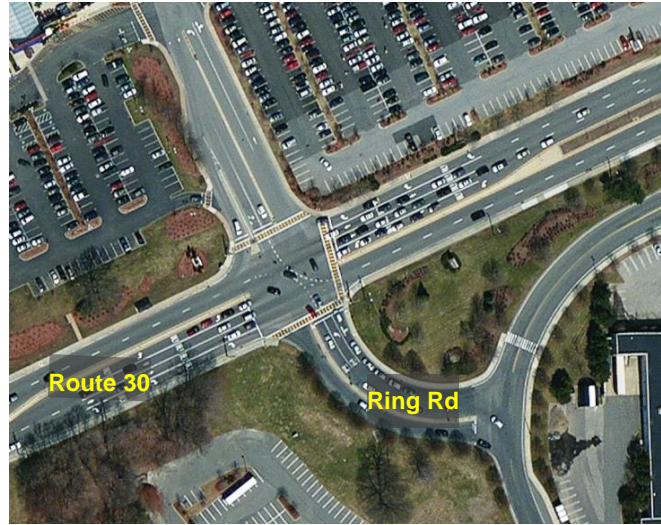
Route 30 intersects Whittier Street/Shopper's World Drive to form a four-leg intersection. The eastbound approach of Route 30 has five lanes (exclusive left turn lane, two through lanes, and exclusive double right-turn lanes), while the westbound approach has three lanes (exclusive left-turn lane, through lane, and shared through/right-turn lane). The intersection curb radii are adequate for truck traffic. The Whittier Street southbound approach consists of four lanes (exclusive left turn lane, shared left/through lane, through lane, and exclusive right-turn lane). The Shopper's World Drive northbound approach consists of three lanes (shared left/through lane, through lane, and exclusive right-turn lane). The intersection has a fully actuated traffic signal with coordination, an emergency vehicle preemption system, and pedestrian signals with pushbuttons. There are crosswalks on all except for the east leg. The land use in the vicinity is commercial.



Route 30 at Whittier Street

#### 4.2.5 *Route 30 at Ring Road/Shopper's World Way*

Route 30 intersects Ring Road and Shopper's World Way to form a four-leg intersection. Each approach of Route 30 has an exclusive left-turn lane, two through lanes, and an exclusive right-turn lane. The Ring Road northbound approach consists of a three lanes (double left-turn lanes and a shared through/right- turn lane), while the Shopper's World Way southbound approach has three lanes (exclusive left-turn lane, shared left/through lane, and exclusive right-turn lane). The intersection curb radii are adequate for truck traffic. The intersection has a fully actuated traffic signal with coordination, emergency vehicle preemption system, and pedestrian signals with pushbuttons. The intersection has crosswalks on all except for the west leg. The land use in the vicinity is commercial.



Route 30 at Ring Road

### 4.3 Land Use and Developments

#### 4.3.1 *Land Use*

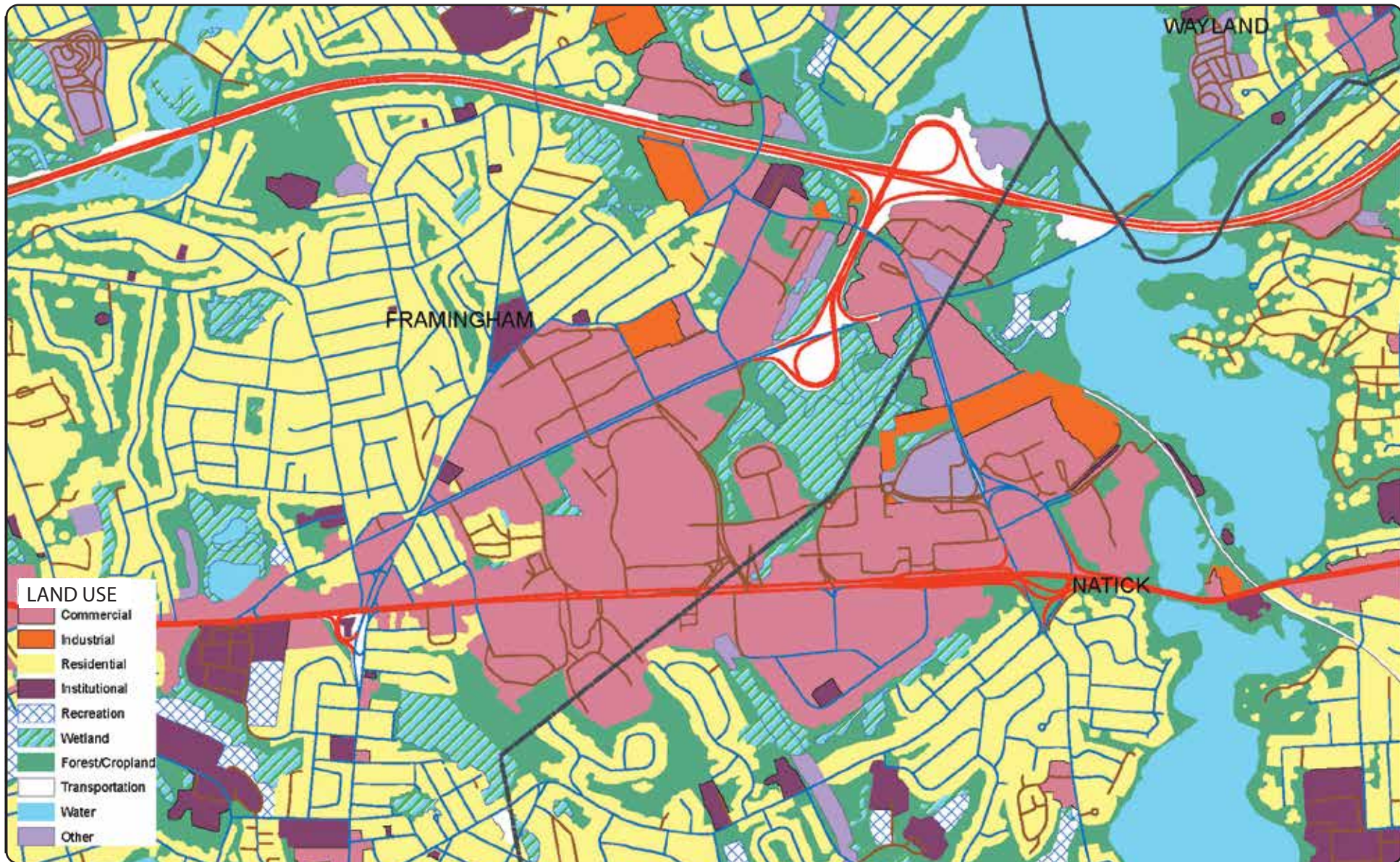
The seen in the land use map (Figure 2) the area surrounding the roadway segment under study is zoned for both commercial and industrial use in Framingham and Natick. The area, known as the Golden Triangle, is a desirable shopping and industrial site. It is designated as a high-priority business development area, and has direct access to the MassPike, Route 9, and Route 30.

#### 4.3.2 *Developments*

Based on discussions with representatives from Framingham and Natick, the following developments are proposed or expected in the area:

- Chrysler Apartments: Construction of 404 apartment units to be located off of Chrysler Road in Natick
- FedEx Ground: Proposed Distribution Facility, Natick
- Boston Scientific Warehouse Reuse: Fully occupied, Natick





BOSTON  
REGION  
MPO



**FIGURE 2**  
**Land Use**

*Priority Corridors for  
LRTP Needs Assessment  
Route 30 in Natick/Framingham*

- Potential redevelopment of some of the existing parcels along Route 30 and Speen Street in Framingham
- Future reuse/conversion of some of the existing properties

#### 4.4 Pedestrian and Bicyclist Accommodation

There are sidewalks on Route 30 in the Framingham and Natick segments; however, they are not continuous or connected. Gaps exist in the sidewalk network in the vicinity of the MassPike and Route 30 ramp junctions. In the Framingham section, the sidewalk on the north side of Route 30 terminates at Burr Street and picks up at the Red Roof Inn near the Speen Street intersection. Similarly, the sidewalk on the south side of Route 30 terminates just east of the FedEx driveway and picks up at the Margaritas restaurant on the southeast corner of the Speen Street intersection. Figure 3 shows the existing sidewalks and gaps near the MassPike-Route 30 ramp junctions.

In the segment under study, pedestrian crossings are permitted only at signalized intersections and crosswalks that are accessible with Americans with Disabilities Act compliant ramps; and pedestrian signals with pushbuttons have been provided at those intersections. The closely spaced intersections make midblock crossing unnecessary. Table 1 presents the number of pedestrians and bicyclists observed at the study intersections during AM and PM peak travel periods when the TMC and ATR counts were conducted. The low pedestrian and bicyclist volumes might have resulted from the colder weather and shorter daylight in November and the high volume of traffic during peak periods. In addition, the low numbers might have been a result of the lack of amenities that intend to provide safety and comfort for bicyclists, such as:

- Shoulders or bicycle lanes
- Shared-lane pavement markings (sharrows) alerting motorists
- Bicycle detection devices (video or loops)

When the proposed CRT is completed and gaps in the sidewalk network are connected, the low pedestrian and bicyclist volumes reported in Table 1 should increase significantly.







**TABLE 1**  
**Pedestrian and Bicycle Counts at the Study Intersections**

	<b>Pedestrian Count: AM Peak Period</b>	<b>Pedestrian Count: PM Peak Period</b>	<b>Bicyclist Count: AM Peak Period</b>	<b>Bicyclist Count: PM Peak Period</b>
Route 30 at TJX Co. Driveway	0	0	0	0
Route 30 at Speen Street	4	4	0	0
Route 30 at Burr Street	1	1	0	1
Route 30 at Whittier Street	5	4	0	0
Route 30 at Ring Road	6	13	0	1

Note: The AM peak period is 7:00 AM to 9:00 AM, and the PM peak period is 4:00 PM to 6:00 PM.  
Source: Central Transportation Planning Staff.

## 4.5 Transit

There are five Metro West Regional Transit Authority (MWRTA) bus services operating within the study area:

- Route 2 Framingham Circuit (clockwise)
- Route 3 Framingham Circuit (counter clockwise)
- Route 10 Natick Daily
- Route 11 Natick
- Natick Commuter Shuttle

Routes 2 and 3 connect South Framingham to Shopper's World and the Natick Mall along a long circuit route; with Route 2 traveling clockwise around the circuit and Route 3 operating counter clockwise. Routes 2 and 3 cross Cochituate Road at Whittier Street and Shopper's World Drive and briefly run along Cochituate Road from Concord Street to Shopper's World. Both routes circulate through Shopper's World and the Natick Mall.

Routes 10, 11, and the Natick Commuter Shuttle operate along Cochituate Road from North Main Street (Route 27) to Speen Street. Routes 10 and 11 connect downtown Natick to the Natick Mall along a circuit route; with Route 10 operating counter clockwise around the loop and Route 11 operating clockwise. The Natick Commuter Bus operates to and from MBTA commuter rail stations in Natick to several major employers in Natick, including MathWorks.

Routes 2, 3, and 10 operate Monday to Saturday, while Route 11 and the Natick Commuter Shuttle operate Monday to Friday only. Routes 2 and 3 operate every 60 to 75 minutes from 6:30 AM to 7:55 PM weekdays and 9:30 AM to 5:30 PM Saturday. Routes 10 and 11 operate every 85 minutes from 6:30 AM to 8:11 PM weekdays. Route 10 also operates on Saturday from 9:30 AM to 5:30 PM. The Natick Commuter Shuttle operates several trips in the AM and PM peak periods.

The MWRTA offers a flag stop where buses stop only on an as-needed or as-requested basis. The average daily ridership from the stop at Macy's at the Natick Mall is 45 riders; the stop at the shelter at Shoppers World has an average of 15 boardings per day. MWRTA has adjusted schedules since 2008 to account for longer travel times in the peak periods. The 2008 weekday data collected on MWRTA routes by MPO staff showed 160 passengers on Route 2; 206 passengers on Route 3; 117 passengers on Route 10; 43 passengers on Route 11; and 69 passengers on the Natick Commuter Shuttle. MWRTA ridership has increased since 2008, but new data by route is not yet available.

#### 4.6 Proposed Cochituate Rail Trail (CRT) Crossing at Route 30

The CRT is a proposed multi-use trail that would extend from the Village of Saxonville in Framingham to Natick Center, a distance of four miles. At the time this writing, the Framingham section of the trail is paved, but not opened to the public, although it is being used now. The Natick section of the trail is in the planning stage. Because of its close proximity to office buildings, shopping centers, and residential areas, the trail is expected to provide residents with an attractive alternative to driving. In addition, a planned connection to the commuter rail station in Natick Center will open the door for even greater transportation use. The Framingham section will terminate at Route 30 near Home Depot and Cochituate State Park. The Natick section will start at the point where the Framingham section ends, and will terminate at the commuter rail station in Natick Center. The Natick section also will have a spur connecting the Cochituate Rail Trail to the Natick Mall.

The relationship between this study and the Cochituate Rail Trail is the crossing of the trail at Route 30 and what impact that would have on the study area. The trail crossing is complicated by the following site conditions:

- Located in a roadway section with high traffic volume, recurrent congestion, and traffic queues. The roadway section has average daily traffic of 22,000 vehicles (both directions) and peak hour traffic of about 2,000 vehicles (both directions).
- Located between two closely spaced traffic signals; one at the Speen Street intersection and the other at the intersection at the TJX Companies driveway.
- Located near the Home Depot and Cumberland Farms driveways on Route 30.

The primary concern of Framingham and Natick is the increased exposure and risk for trail users because of the conditions listed above, as well as the effect the trail might have by crossing over traffic operations in the vicinity. One of the objectives of this study was to evaluate the alternatives for trail users to cross

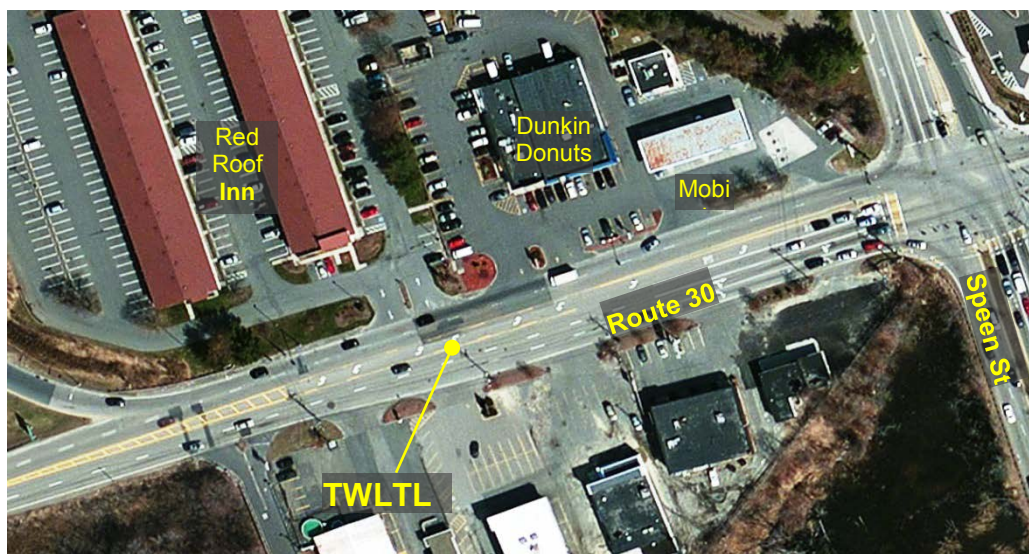
Route 30 safely while considering what the delay consequences for both trail users and motorists would be.

#### 4.7 Safety Conditions

MPO staff used crash data obtained from the Framingham and Natick Police Departments and from the MassDOT Registry of Motor Vehicles to evaluate safety for motorists, pedestrians, and bicyclists. The crash data cover the period from January 2007 through December 2012. The details of the crashes in terms of severity, manner of collision, and ambient light conditions at each of the study intersections are presented in Table 2. The crash rates for the study intersections presented at the bottom of Table 2 were calculated per MassDOT methodology. The MassDOT Highway Division's District 3 average crash rate (published by MassDOT based on crash information queried on January 23, 2013) is 0.89 crashes per million entering vehicles for signalized intersections. The crash rate worksheets and collision diagrams are located in Appendix C. Using the District 3 crash rate data as a threshold, none of the study intersections was identified as a high-crash location.

Although the Route 30 and Speen Street intersection had 85 crashes within the six-year period, it did not meet the District 3 threshold because of the high ADT volumes at the intersection. The most prevalent crash types were angle and rear-end collisions because of running red lights, failure to yield right-of-way, and following too close, inattention, and inability to stop in reaction to a traffic queue.

In addition, between 24 and 30 percent of the crashes occurred during peak travel periods—when there are congestion and traffic queues. In addition, the segment of Route 30 west of Speen Street, with the two-way center left-turn lane (TWLTL) had 22 crashes.



Two-Way Left-Turn Lane (TWLTL) on Route 30 Near Speen Street



**TABLE 2**  
**Crash Summaries and Rates for Study Intersections**

	<b>Route 30 at Speen Street</b>	<b>Route 30 at Burr Street</b>	<b>Route 30 at Whittier Street</b>	<b>Route 30 at Ring Road</b>	<b>Route 30 at TJX Driveway</b>
Fatal Injury	0	0	0	0	0
Non-fatal injury	22	17	20	0	6
Property damage only	58	30	40	21	6
Unknown/not reported	5	0	3	0	1
Angle	32	12	17	7	5
Rear-end	34	24	27	6	4
Sideswipe	11	6	11	5	0
Single-vehicle crash	1	3	5	0	4
Head-on	2	1	0	1	0
Unknown/not reported	5	1	3	1	0
Pedestrians	0	0	0	0	0
Bicyclists	1	1	0	0	0
AM or PM peak period*	29	14	15	6	1
Non-peak period	56	33	48	15	12
Dry	51	35	49	13	12
Wet or icy	16	12	14	8	1
Daylight	69	38	47	18	10
Dark (lit or unlit)	16	9	16	3	3
Total crashes	85	47	63	21	13
Six-year average	14	8	11	4	2
Crash rate	0.7	0.51	0.76	0.34	0.37
District 3 average crash rate	0.89	0.89	0.89	0.89	0.89

\* The AM peak period is 7:00 AM to 9:00 AM, and the PM peak period is 4:00 PM to 6:00 PM.  
Source: Central Transportation Planning Staff.

## 4.8 Traffic Operations Conditions

The average weekday traffic volumes on Route 30 ranged between 22,000 and 40,000 vehicles per day. The highest ADT occurred in the segment between Speen Street and the MassPike and the lowest ADT occurred in the segment between the TJX Companies driveway and the Speen Street intersection. The percentage of trucks in the study-area intersections during the AM and PM peak periods ranged between 1.0% and 2.8% (Table 3). These truck rates are not considered particularly high for peak-period traffic conditions. Also, staff did

not detect any roadway geometry—such as turning radii, which would inhibit truck traffic flow—other than the extreme traffic congestion that exists in this area during peak hours and affects all traffic. The peak-hour turning movement volumes for the study intersections and the MassPike ramps are presented in Figure 4.

Using the data and information collected, MPO staff built a traffic analysis network for the AM and PM peak periods (with Synchro Studio<sup>4</sup>) to assess the capacity and quality of traffic flow in the arterial segment under study.

**TABLE 3**  
**Percentage of Heavy Vehicles at Study Intersections during Peak Periods\***

<b>Intersection/Approach</b>	<b>Percent of Heavy Vehicles</b>
<b><i>Route 30 at TJX Companies Driveway:</i></b>	
Route 30 Eastbound	--
Route 30 Westbound	1.2%
TJX Driveway Southbound	1.0
<b><i>Route 30 at Speen Street:</i></b>	
Route 30 Eastbound	--
Route 30 Westbound	2.0%
Speen Street Northbound	2.1
Speen Street Southbound	2.2
<b><i>Route 30 Burr Street:</i></b>	
Route 30 Eastbound	--
Route 30 Westbound	2.0%
Burr Street Northbound	2.0
Burr Street Southbound	1.4
<b><i>Route 30 at Whittier Street:</i></b>	
Route 30 Eastbound	--
Route 30 Westbound	2.4%
Whittier Street Northbound	2.5
Whittier Street Southbound	1.0
<b><i>Route 30 at Shopper's World Way/Ring Road:</i></b>	
Route 30 Eastbound	--
Route 30 Westbound	2.8%
Shopper's World Way Southbound	1.8
Ring Road Northbound	2.4

\* The AM peak period is 7:00 AM to 9:00 AM, and the PM peak period is 4:00 PM to 6:00 PM.  
Source: Central Transportation Planning Staff.

<sup>4</sup> Trafficware Inc., Synchro Studio 8, Synchro plus SimTraffic, Build 801, Version 563, Sugar Land, Texas.



**FIGURE 4**  
**Existing Peak-Hour Turning-Movement Volumes**



The analyses were conducted in a manner consistent with the Highway Capacity Manual (HCM) methodologies (included in Appendix D). The HCM methodology demonstrates the driving conditions at signalized intersections in terms of LOS ratings from A through F. LOS A represents the best operating conditions (little to no delay), while LOS F represents the worst operating conditions (very long delay). LOS E represents operating conditions at capacity (limit of acceptable delay). The control delays associated with each level of service for signalized intersections are presented in Table 4.

**TABLE 4**  
**Levels of Service and Control Delays at Signalized Intersection**

Level of Service	Control Delay (seconds per vehicle)
A	≤ 10
B	> 10-20
C	> 20-35
D	> 35-55
E	> 55-80
F	> 80

Source: Central Transportation Planning Staff.

Table 5 presents the peak-hour performance measures for the existing conditions, summarized below:

1. The Route 30 and Speen Street intersection is the most critical in the corridor. It operates at capacity (LOS E or F) during AM and PM peak periods, when long queues form on its approaches, interrupting traffic flow at the TJX Companies driveway, Speen Street, and Route 30. The most severe delays and queues are in the PM peak period, especially for the Speen Street northbound left-turning traffic.
2. The intersection of Route 30 and TJX Companies driveway operates at LOS F during the PM peak period, when a traffic surge as a result of employee traffic (5:00 PM to 5:45 PM) and queues on the east leg of the Route 30 and Speen Street intersection spills into it, making it difficult for employees to exit from the company driveway onto Route 30. A police detail conducts traffic at that intersection during the PM peak period, sidestepping the traffic signal control.
3. The intersection of Route 30 and Whittier Street operates at an unacceptable LOS F during the PM peak hour. During this time, traffic on the Whittier Street southbound approach operates at LOS F and experiences a long traffic queue.

**TABLE 5  
Peak-Hour Level of Service, Delay, and Queue: Existing versus Retimed Traffic Signals**

Intersection/ Approach	Move-ment	AM Existing LOS	AM Existing Delay <sup>a</sup>	AM Existing Queue <sup>b</sup>	AM Retimed LOS	AM Retimed Queue	AM Retimed Queue	PM Existing LOS	PM Existing Delay	PM Existing Queue	PM Retimed LOS	PM Retimed Delay	PM Retimed Queue
<b>Route 30 at TJX Driveway:</b>													
Route 30 Eastbound	L	C	27	#587	C	22	#574	B	10	20	B	10	20
Route 30 Eastbound	T	A	6	450	A	5	450	A	6	#335	A	6	335
Route 30 Westbound	T	C	37	#550	C	33	#550	E	55	#559	E	55	#559
Route 30 Westbound	R	B	20	51	A	19	51	B	14	12	B	14	12
TJX Driveway	L	D	44	25	D	42	25	D	39	#122	C	39	#122
TJX Driveway	R	B	14	15	A	13	15	D	40	#540	D	40	#540
<b>Intersection Total</b>	<b>All</b>	<b>C</b>	<b>21</b>	<b>--</b>	<b>B</b>	<b>18</b>	<b>--</b>	<b>C</b>	<b>32</b>	<b>--</b>	<b>C</b>	<b>32</b>	<b>--</b>
<b>Route 30 at Speen Street:</b>													
Route 30 Eastbound	L	E	77	#410	E	71	#414	E	66	155	E	68	#170
Route 30 Eastbound	T+R	E	62	#859	E	76	#801	F	87	#541	E	60	#415
Route 30 Eastbound	R	C	22	513	C	27	#818	F	85	#1159	E	62	#979
Route 30 Westbound	L	F	84	#315	E	73	#289	E	76	#529	F	84	#541
Route 30 Westbound	T+R	D	43	264	D	44	255	D	51	#535	D	42	468
Speen St. Northbound	L	E	60	#434	E	55	#414	F	131	#715	F	115	#620
Speen St. Northbound	T+R	F	120	#715	F	80	#625	D	42	341	D	42	316
Speen St. Southbound	L	E	71	#193	E	75	#223	E	76	#190	E	64	158
Speen St. Southbound	T	F	97	#324	E	71	#296	E	65	#450	F	97	#465
Speen St. Southbound	R	D	36	43	C	32	40	E	59	#449	E	70	#444
<b>Intersection Total</b>	<b>All</b>	<b>E</b>	<b>67</b>	<b>--</b>	<b>E</b>	<b>60</b>	<b>--</b>	<b>E</b>	<b>76</b>	<b>---</b>	<b>E</b>	<b>70</b>	<b>--</b>
<b>Route 30 at Burr Street:</b>													
Route 30 Eastbound	L	E	57	m176	D	45	m126	D	45	m72	D	50	m79
Route 30 Eastbound	T+R	A	5	124	A	10	124	A	8	m15	C	28	m450
Route 30 Westbound	T	B	15	250	B	16	257	C	27	582	D	43	#706
Route 30 Westbound	R	E	56	#676	E	59	#675	B	16	73	C	20	87
Burr St. Northbound	L+T	E	65	#105	D	49	93	F	97	#130	D	54	101
Burr St. Northbound	R	A	1	0	A	1	0	A	1	0	A	1	0
Burr St. Southbound	L	D	39	75	D	38	68	E	148	#492	D	50	#402
Burr St. Southbound	L+T+R	D	37	62	D	38	69	F	143	#478	D	49	#385
<b>Intersection Total</b>	<b>All</b>	<b>C</b>	<b>29</b>	<b>--</b>	<b>C</b>	<b>30</b>	<b>--</b>	<b>D</b>	<b>37</b>	<b>--</b>	<b>D</b>	<b>35</b>	<b>--</b>
<b>Route 30 at Whittier Street:</b>													
Route 30 Eastbound	L	D	41	#94	D	54	#65	E	66	m88	E	71	m#80
Route 30 Eastbound	T	C	35	#370	C	30	#479	C	30	m#182	D	51	m302
Route 30 Eastbound	R	B	18	0	B	18	0	C	34	m16	C	34	m13
Route 30 Westbound	L	D	42	#240	D	45	#240	C	26	m#525	E	55	m#460
Route 30 Westbound	T+R	A	10	#547	B	11	#547	B	19	m#725	B	13	m#656
Shopper's World Dr.	L+T	D	36	54	D	36	54	F	> 180	#259	F	101	#234
Shopper's World Dr.	R	C	22	0	C	22	0	C	24	9	C	22	84
Whittier St. Southbound	L	D	44	#131	D	44	#131	F	> 180	#375	E	64	#336

Intersection/ Approach	Move- ment	AM Existing LOS	AM Existing Delay <sup>a</sup>	AM Existing Queue <sup>b</sup>	AM Retimed LOS	AM Retimed Queue	AM Retimed Queue	PM Existing LOS	PM Existing Delay	PM Existing Queue	PM Retimed LOS	PM Retimed Delay	PM Retimed Queue
Whittier St. Southbound	L+T	D	39	#96	D	40	#96	F	> 180	#353	E	72	#282
Whittier St. Southbound	R	C	28	0	C	28	0	D	38	14	C	34	15
<b>Intersection Total</b>	<b>All</b>	<b>C</b>	<b>26</b>	<b>--</b>	<b>C</b>	<b>26</b>	<b>--</b>	<b>F</b>	<b>81</b>	<b>--</b>	<b>D</b>	<b>47</b>	<b>--</b>
<b>Route 30 at Ring Road:</b>	--	--	--	---	---	--	---	--	--	---	--	--	--
Route 30 Eastbound	L	C	33	m#171	D	47	m#172	E	64	#303	C	33	#274
Route 30 Eastbound	T	B	11	#480	A	10	#446	B	26	312	B	16	307
Route 30 Eastbound	R	B	11	m17	B	11	m4	D	51	91	C	25	87
Route 30 Westbound	L	D	38	m26	C	28	m26	E	59	m74	D	37	m68
Route 30 Westbound	T	D	41	#435	C	33	#442	D	39	m436	D	52	m#463
Route 30 Westbound	R	B	15	m67	B	13	m67	C	28	m80	F	86	m95
Shopper's World Way	L	D	36	23	D	36	23	E	77	#132	D	51	#121
Shopper's World Way	T+R	D	38	52	D	38	52	F	>180	#284	F	131	#288
Ring Road Southbound	L	D	37	41	D	38	41	E	77	#148	E	60	#125
Ring Road Southbound	L+T	D	37	42	D	38	42	E	77	#154	E	60	#129
Ring Road Southbound	R	D	36	0	D	36	0	D	49	24	C	31	31
<b>Intersection Total</b>	<b>All</b>	<b>C</b>	<b>29</b>	<b>--</b>	<b>C</b>	<b>24</b>	<b>--</b>	<b>E</b>	<b>56</b>	<b>--</b>	<b>D</b>	<b>46</b>	<b>--</b>

<sup>a</sup> Delay in seconds per vehicle. <sup>b</sup> 95th percentile queue length in feet.

LOS = Level of service. m = Volume for the 95th percentile queue is metered by an upstream signal. # = The 95th percentile volume exceeds capacity.

Source: Central Transportation Planning Staff.

4. Traffic on the Burr Street southbound approach operates at an unacceptable LOS F during the PM peak hour and experiences a long traffic queue.
5. A traffic queue on the MassPike on-ramp near the Red Roof Inn sometimes backs up onto Route 30 westbound during the PM peak period. To a lesser degree, this has been happening in the AM peak period because of solar glare and heavy volumes on the eastbound MassPike. This condition slows traffic heading westbound on Route 30 and contributes to the congestion and queues at the Speen Street intersection.

#### 4.9 Previous and Proposed Mitigation Improvements

The following are previous and proposed mitigation improvements; not all of these improvements are in the study area but are listed here because they affect flow into and out of the study area.

1. The Lowe's Companies, Inc. development on Route 30, implemented several mitigation actions to improve traffic safety, operations, and aesthetics on Route 30 (see Appendix E for full list of mitigation actions), among which were:
  - Upgrade of the Beacon Street traffic signal (completed)
  - Geometric and signal retiming improvements at the intersection of Route 30 and Ring Road and Lowe's/Target driveway (completed)
  - A secondary driveway on Route 30 at the western edge of the Lowe's site to access the store (completed).
  - Curb improvements between Caldor Road and Whittier Street (completed)
  - Landscape improvements between Route 126 and Caldor Road (completed)
2. Traffic signals on Route 30 from Beacon Street to Burr Street were retimed and coordinated in 2007.
3. A traffic signal upgrade and intersection improvements have been planned for the intersection of Route 30 and Route 27 in Wayland. This project has been programmed into the Transportation Improvement Program (TIP) for the federal fiscal year (FFY) 2016 and it currently is in design.
4. The proposed FedEx distribution facility in Natick has discussed traffic mitigation measures with the Town of Natick to improve safety, operations, and mobility on Speen Street, which include modifying the

signal timing plan for the Route 30 and Speen Street intersection to reduce delay. (See Appendix E for full list of traffic mitigation measures.)

5. MassDOT proposes to convert and replace the I-90 Western Turnpike interchange-based manual cash and electronic toll collection systems with its new system All Electronic Tolling system. The project will include both roadway tolling infrastructure and toll collection system technology.

## 5. FUTURE CONDITIONS

To systematically forecast future traffic volumes resulting from changes in a transportation network or land use, a planning model is used. For this study, staff used the Boston Region MPO's most-recently adopted regional travel demand model set, with socioeconomic components based on forecasts produced by the Metropolitan Area Planning Council. The model is calibrated at a regional level for 164 cities and towns, which include all of the 101 cities and towns in the MPO region. The primary tool used in model calibration is the transportation planning model set implemented in EMME software.<sup>5</sup> Total average traffic growth in the study area is projected to be approximately 3.0 percent by 2020; this factor was used to expand existing peak-hour turning-movement volumes into 2020 future turning-movement volumes (Figure 5).

## 6 IMPROVEMENTS

### 6.1 Pedestrian Accommodation

#### 6.1.1 *Sidewalks/Multiuse Path*

Three options were proposed to address gaps in sidewalks on Route 30 in the vicinity of the MassPike:

- Option 1: Improve existing sidewalks on Burr Street and Leggat McCall Connector Road for access to Speen Street and the Cochituate Rail Trail (Figure 6), and add shared-lane markings on these streets for bicyclists.
- Option 2: Construct new sidewalks on the south side of Route 30 in the vicinity of the MassPike connector ramps to provide continuous and connected sidewalk for accessing businesses near the Route 30 and Speen Street intersection and the Cochituate Rail Trail (Figure 7).

---

<sup>5</sup> EMME 3, Transport Modeling, INRO, Westmount, Montreal, Quebec, Canada.





**FIGURE 5**  
2020 Peak-Hour Turning-Movement Volumes





**FIGURE 6**  
Option 1: Use Existing Sidewalks on Burr Street,  
Leggatt McCall Connector Road, and Speen Street







**FIGURE 7**  
Option 2: Continuous and Connected Sidewalks on South Side of Route 30







**FIGURE 8**  
**Option 3: Continuous and Connected Sidewalks/Multiuse Path**  
**on South Side of Route 30 and Outer Loop of MassPike Connector**



- Option 3: Construct new sidewalks and multiuse paths around the outer loop of the MassPike connector south of Route 30 for accessing businesses near the Route 30 and Speen Street intersection and the Cochituate Rail Trail (Figure 8 above).

Cost and effectiveness are the two primary factors for selecting the preferred option. Option 1 offers the least cost, makes use of existing sidewalks, avoids crossing busy MassPike connector ramps, connects to the Cochituate Rail Trail, and it is on a roadway where pedestrians would encounter far less traffic than on Route 30. However, Option 1 lacks direct connections to the businesses at the Route 30 and Speen Street intersection.

Option 2 crosses two busy MassPike connector ramps, requires crosswalk warning devices for crossing the MassPike ramps safely, and costs much more than Option 1. However, Option 2 provides direct access to businesses at the Route 30 and Speen Street intersection and to the Cochituate Rail Trail.

Option 3 provides access to businesses at the Speen Street intersection and to the Cochituate Rail Trail and avoids crossing busy MassPike connector ramps. In addition, Option 3 has greater potential for attracting bicyclists to the Cochituate Rail Trail.

In addition to closing gaps in the sidewalk network, MPO staff also suggests the installation of sidewalk buffers, countdown pedestrian signal timers, shared-lane markings, and bicycle detectors, which are described in the following sections.

### 6.1.2 *Sidewalk Buffers*

Install a two-to-three foot wide buffer between the roadway curb and existing sidewalks on Route 30 between Ring Road and Burr Street. A sidewalk buffer provides a comfortable separation and safety for pedestrians from the street and vehicles. A sidewalk buffer is desirable along Route 30 in the study area, where on-street parking is prohibited, and shoulders and bike lanes are absent. This improvement also could be considered as a mitigation project.



Sidewalk without a buffer on Route 30



Sidewalk with grass buffer on Whittier Street



### 6.1.3 Countdown Timer Displays

Pedestrian countdown signals improve safety by helping pedestrians make informed decision about crossing streets at signalized intersections. MPO staff recommends adding countdown displays to the existing pedestrian signal heads, especially on the traffic signal at the intersection of Route 30 and Ring Road/Shopper's World Way, which appears to have the largest number of pedestrian crossings.

## 6.2 Bicycle Accommodation

Install shared-lane markings (sharrows) in the rightmost through travel lanes on Route 30 to inform motorists to share the road, and reduce the speed limit to 35 mph from 40 mph. This also would benefit Cochituate Rail Trail users, as Route 30 would be one of the connecting roadways to the trail. Sharrows on Burr Street and Leggat McCall Connector Road would benefit bicyclists, if sidewalk Option 1 is selected.

Install bicycle detectors (video or loop) at the signalized intersections and provide bicycle detector pavement markings or signs indicating to bicyclists where to stop to wait for the green indication. Bicycle detectors at the intersection of Leggat McCall Connector Road and Speen Street would benefit bicyclists, if sidewalk Option 1 is selected.

These treatments could be extended east and west of the study area in order to increase benefits and effectiveness.



Bicycle detector pavement marking



Shared-lane markings (sharrows)

## 6.3 Traffic Operations

### 6.3.1 *Retime Traffic Signals*

Traffic signals on Route 30 from Beacon Street to Burr Street in Framingham were retimed and coordinated in 2007, in order to establish efficient traffic flow processing. Using Synchro Studio, MPO staff evaluated the new timing plans, including those for signals at the Speen Street and TJX Companies driveway. The process was performed for both the AM and PM peak periods; and the results—including intersection levels of service, delays, and queues—are presented in Table 5. The results show that:

- The existing cycle length, phase sequence, and offsets for the coordinated traffic signal systems work well both in the AM and PM peak period. However, fine tuning is needed to increase green times during the PM peak period for the side streets of Burr and Whittier Streets.
- In addition, MPO staff suggests the following improvements:
  - Increase the yellow change interval to 4 seconds from 3 seconds for the Route 30 and Burr Street intersection
  - Increase the all-red time to 2 seconds from 1 second for the Route 30 and Whittier Street intersection
  - Increase the yellow change interval to 4 seconds from 3.2 seconds for the Route 30 and Ring Road intersection

Increasing the yellow change and all-red clearance intervals could reduce the angle crashes at the signalized intersections.

- As a short-term improvement, the Speen Street signal could benefit somewhat from retiming. Analysis shows that the overall intersection delay could be reduced to 60 seconds per vehicle (LOS E) from 67 seconds per vehicle (LOS E) during the AM peak period. Similarly, the overall intersection delay could be reduced to 70 seconds per vehicle (LOS E) from 76 seconds per vehicle (LOS E) during the PM peak period. The improvement resulting from signal retiming would not reduce congestion significantly at the intersection—other strategies in addition to the retiming are needed to increase capacity and improve safety for the long term.
- The traffic signal at the TJX Companies driveway intersection operates satisfactorily during the AM peak-hour. The mediocre traffic operation during the PM peak period results from a traffic queue created on the Route 30 westbound approach at Speen Street that spills into this intersection. Analysis shows that the signal at the TJX Companies driveway would operate satisfactorily during the PM peak

period if a queue does not extend into it. Retiming of the Route 30 and Speen Street intersection would not reduce the queue enough to require the police detail at the intersection to be removed.

### 6.3.2 *Consolidate Driveways on Route 30 Segment with the TWLTL*

The segment of Route 30 with the two-way left-turn lane had a large number of angle-type crashes involving motorists turning into or out of driveways, with primary contributing factors as failure to yield right-of-way and changing lanes. This segment carries an ADT of 40,000-to-44,000 vehicles per day (both directions). TWLTLs are less effective and have high crash rates in locations where there is a density of commercial closely spaced driveway. In addition, TWLTLs start to lose their effectiveness when traffic volumes on a roadway are high—studies indicate that operating degradation occurs between an ADT of 24,000-to-28,000 vehicles per day (both directions).<sup>6,7</sup>

MPO staff suggests the following safety improvement options for consideration (Figure 9):

- The Town of Framingham should work with the business owners in the area to effectively manage driveway spacing in this segment by consolidating some of the driveways. This will require business owners in the vicinity to share driveways and rearranging some of the existing parking spaces to ensure safety and efficient internal circulation.
- Or, the town should consider redeveloping the existing land uses.
- Or, the town should consider replacing the TWLTL with a raised median and restrict access/egress to business driveways in the segment to right-turn-in and right-turn-out.
- In addition, a raised median or traversable granite cobble median should be installed to separate the eastbound left-turn lanes from the opposing westbound through lanes, thus preventing motorists from cutting across the left-turn lane to go eastbound.

---

<sup>6</sup> Iowa State University, Iowa Access Management Research and Awareness Project, CTRE, 1997.

<sup>7</sup> Peter S. Parsonson, Development of Policies and Guidelines Governing Median Selection, School of Civil Engineering, Georgia Institute of Technology, Sponsored Research Project No. E-20-841, 1990.





**FIGURE 9**  
**Consolidate Driveways and Install Median Treatments**





### 6.3.3 *Improvement Concepts for Route 30 and Speen Street Intersection*

Currently, the Route 30 and Speen Street intersection is operating at capacity during peak periods; and analysis shows that a traffic signal retiming strategy likely would not improve capacity. Peak period traffic demands at the intersection are so high that a traffic queue is created on each approach, which last for two hours or more.

In addition, wetlands and businesses adjacent to the intersection place constraints on further widening the roadway. An evaluation of traffic flow patterns in the vicinity of the intersection indicated that on average, about 70 percent of traffic heading westbound on Route 30 just west of the Speen Street intersection proceeds to the MassPike. Based on this observation, MPO staff expects that the majority of the high-volume northbound left-turn, southbound right-turn, and, to a lesser degree, westbound straight-through traffic at the Speen Street intersection are destined to the MassPike.

In addition, MassDOT proposes to convert and replace the I-90 Western Turnpike interchange-based manual cash and electronic toll collection systems with its new All Electronic Tolling system. The project will include both roadway tolling infrastructure and toll collection system technology. Discussions with MassDOT Highway Division District 3 officials indicated that the District is interested a global approach to alleviate congestion at Route 30 and Speen Street intersection

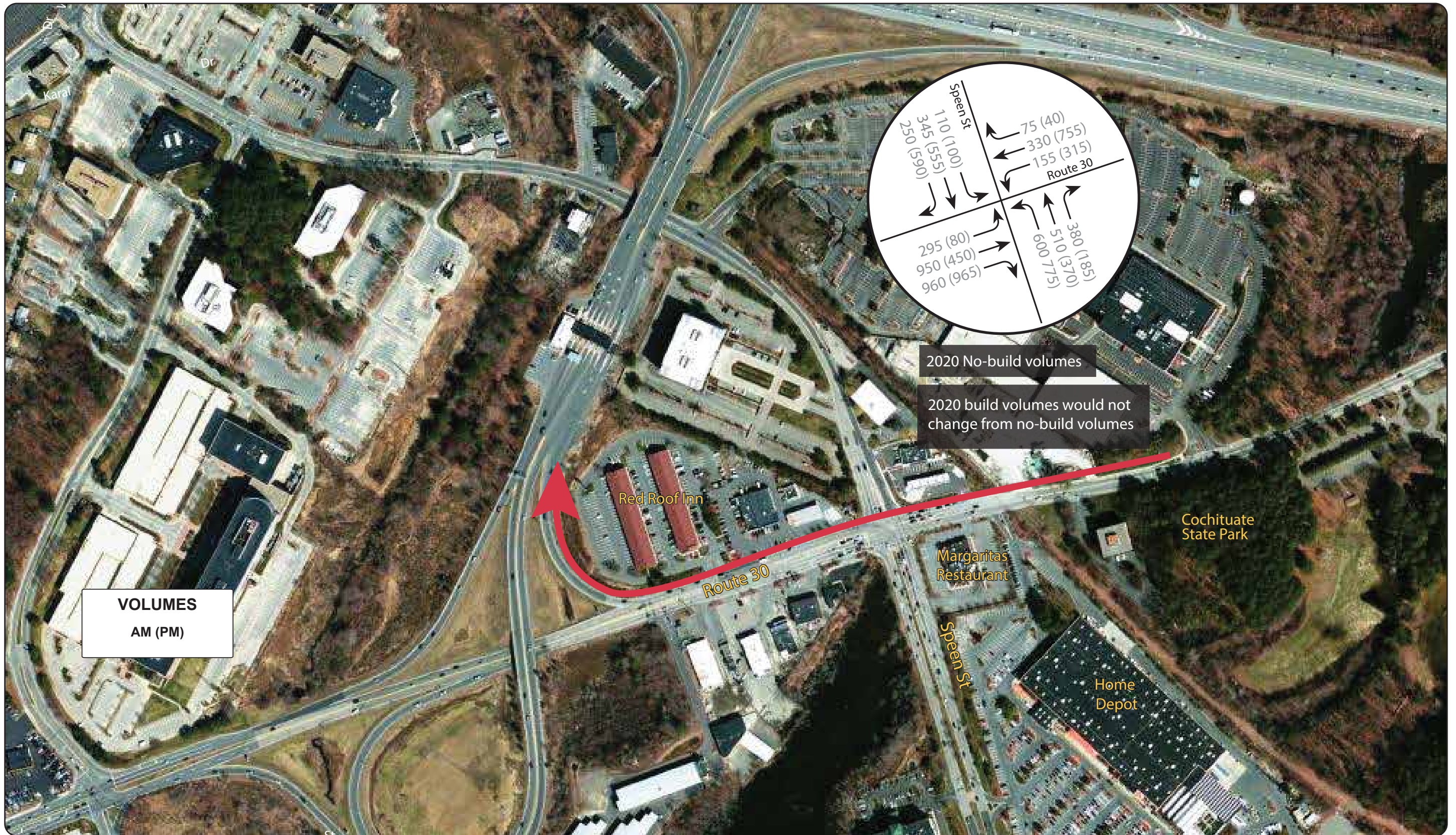
MPO staff developed one medium- and five long-term improvement concepts for consideration (Figures 10 through 15), each of which would need further analysis to determine their effect on congestion, access to businesses, and the environment.

#### Medium-term Concept

At the recommendation of the task force, MPO staff tested the addition of a traffic lane in the westbound direction of Route 30 from the TJX driveway through the Speen Street intersection, continuing as a third lane west of Speen Street up to the existing I-90 on-ramp, which would be reconstructed as two lanes (Figure 10).

Intersection analysis (Appendix D) showed that the level of service at the Route 30 and Speen Street intersection would improve slightly and delays per vehicle and queues would be reduced by as much as 20% and 40%, respectively. The exact reductions vary with peak period, approach, traffic movement, and traffic signal design parameters.

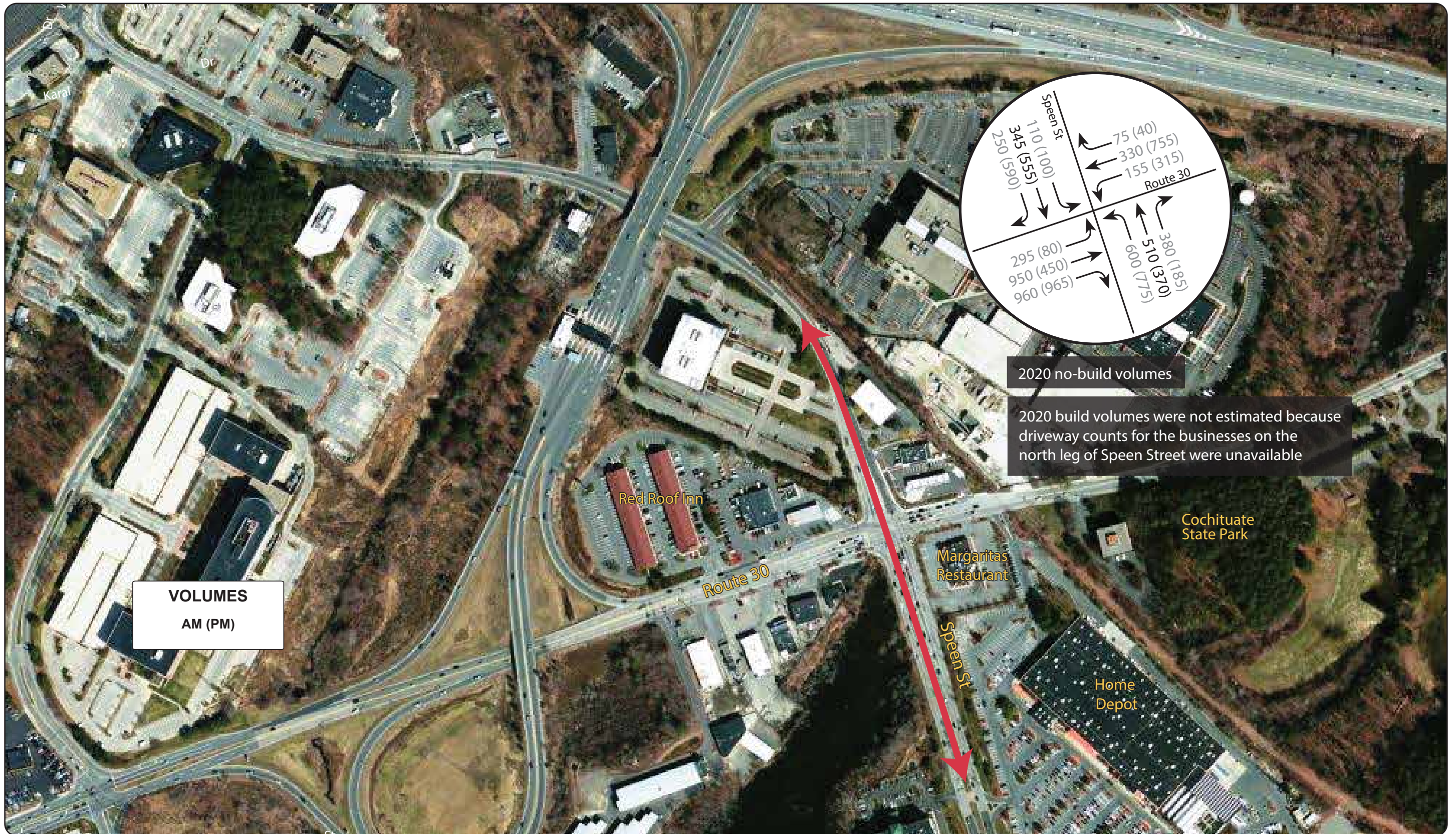
The addition of a third through lane westbound would have impacts in the areas of right-of-way and safety:



**FIGURE 10**  
Medium-Term Concept: Add a Lane in the Westbound Direction of Route 30  
from the TJX Entrance to the MassPike Westbound On-ramp



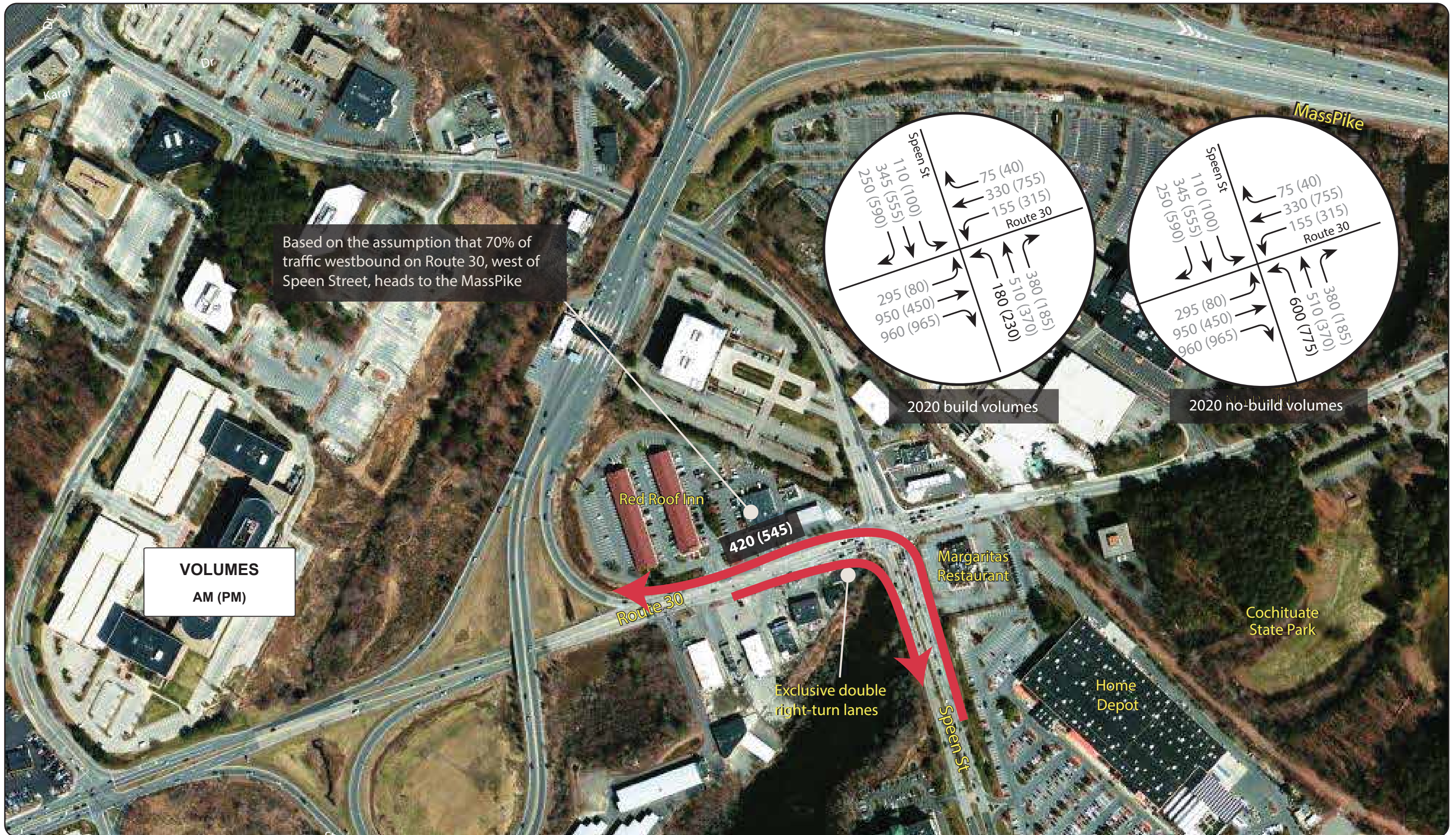




**FIGURE 11**  
Concept 1: Speen Street Northbound and Southbound Through Movements Over Route 30



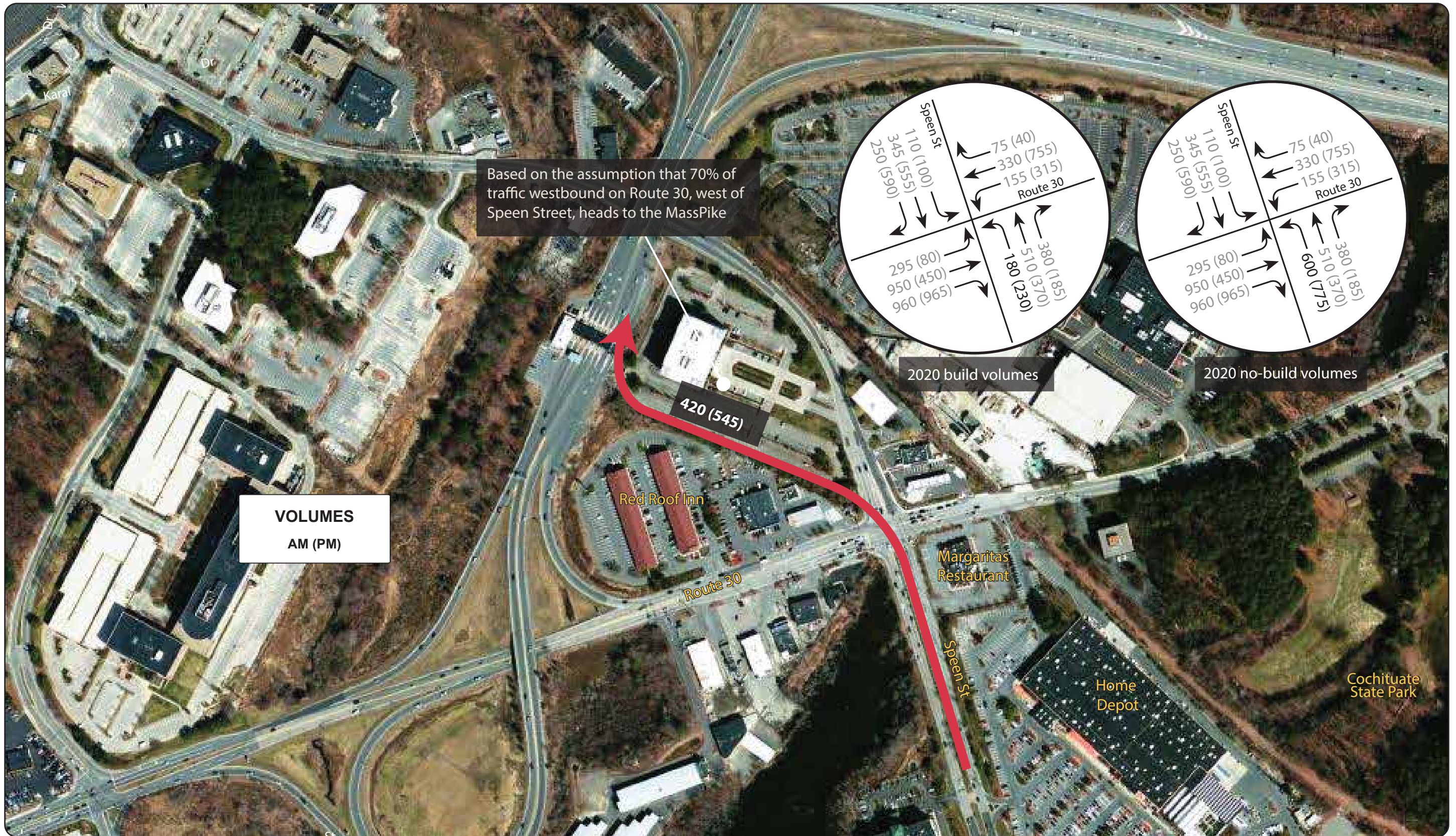




**FIGURE 12**  
**Concept 2: Grade-Separated Spenn Street Northbound Left Turn and  
 Route 30 Eastbound Exclusive Double Right Turn Lanes**







**FIGURE 13**  
**Concept 3: Grade-Separated Median Left Turn from Spenn Street Northbound to MassPike (Eastbound and Westbound)**







**FIGURE 14**  
**Concept 4: Grade Separated Median Left Turn from Speen Street Northbound to MassPike (Eastbound Only)**







*Source: Fehr and Peers, Salt Lake City*





- Taking land from private properties along Route 30—including Cumberland Farms, Dunkin' Donuts, and Red Roof Inn—likely would be required.
- There would be probable escalation of existing crashes between vehicles traveling along Route 30 and vehicles entering and exiting driveways.

In order for the medium-term improvement to work successfully, MPO staff recommends that the two-way left-turn lane in the segment just west of Speen Street be replaced with a raised median, and access/egress to business driveways is restricted to right-turn-in and right-turn-out only.

### Long-term Concepts

Concept 1: Speen Street northbound and southbound through movements over Route 30 (Figure 11). Figure 11 shows only 2020 no-build volumes because peak-period driveway volumes to/from the businesses on the north leg of Speen Street were not available for estimating 2020 build volumes.<sup>8</sup>

Concept 1 would reduce congestion at the Route 30 and Speen Street intersection because the new bridge would take Speen Street through traffic out of the intersection, and the savings in green time could be allocated to other movements at the intersection in order to reduce congestion. Concept 1 would have impacts in the areas of right-of-way and access and egress, particularly on the north leg of Speen Street. The width of the right-of-way on the north leg of Speen Street varies from 40 feet to 90 feet wide, and it would not provide enough space to accommodate a two-lane bridge plus access roads for the businesses. In addition, the bridge would restrict access and egress to businesses on the north leg of Speen Street to right-turn-in and right-turn-out only.

Concept 2: Grade-separated Speen Street northbound left turn and Route 30 eastbound exclusive double right-turn lanes (Figure 12). As part of Concept 2, the MassPike westbound on-ramp would be reconstructed as two lanes. An evaluation of traffic flow patterns in the vicinity of the Route 30/Speen Street intersection indicated that on average, about 70 percent of traffic heading westbound on Route 30 west of the Speen Street intersection proceeds to the MassPike. Consequently, the 2020 build volumes presented in Figure 12 are based on the assumption that about 70 percent of the Speen Street northbound left-turn movement would head to the MassPike via the grade-separation.

Concept 2 would reduce congestion at the Route 30/Speen Street intersection because the grade-separation would take the majority of the high-volume

---

<sup>8</sup> Total average traffic growth in the study area is projected to be approximately 3.0 percent by 2020; this factor was used to expand existing peak-hour turning-movement volumes into 2020 future turning-movement volumes.

Speen Street northbound left turns out of the intersection, and the savings in green time could be allocated to other movements at the intersection in order to improve traffic operations. Concept 2 would have impacts in the areas of right-of-way and access and egress to businesses along Route 30, including Dunkin' Donuts and Red Roof Inn. The right-of-way on Route 30 where the new overpass would land is approximately 100 feet wide and it would not provide enough space to accommodate existing travel lanes and landing of the new overpass (one travel lane, 28 feet wide from parapet to parapet). The overpass would also restrict access and egress to businesses on the north side of Route 30.

Concept 3: Grade-separated median left turn from Speen Street northbound to MassPike (eastbound and westbound) (Figure 13). The 2020 build volumes and ramp volumes presented in Figure 13 are based on the same assumption described in Concept 2. In addition, Concept 3 would reduce congestion at Route 30/Speen Street intersection in the same way as in Concept 2.

Concept 3 would have impacts in the area of right-of-way because its construction would require land taking in the northwest quadrant of the intersection, which would impact properties of the Red Roof Inn and the building at 111 Speen Street. In addition, the right-of-way on the south leg of Speen Street varies in width from about 100 feet in the Framingham segment to about 80 feet in the Natick segment, which is not sufficient to accommodate two travel lanes in each direction plus grade-separation (one travel lane, 28 feet from parapet to parapet), horizontal clearances, shoulders, and sidewalks.

Concept 4: Grade-separated median left-turn from Speen Street northbound to MassPike (eastbound only) (Figure 14). The 2020 build volumes in Figure 14 are based on following two assumptions:

- Approximately, seventy percent of the Speen Street northbound left-turn movement heads to the MassPike.
- Directional split of traffic heading to the MassPike north of the toll plaza (from existing ramp counts conducted in 2010) is approximately 80 percent eastbound and 20 percent westbound during the AM peak hour; during the PM peak hour, the split is about 50 percent in each direction.

Concept 4 would reduce congestion at the Route 30/Speen Street intersection in the same way as in Concept 3. In addition, Concept 4 would have similar impacts in the area of right-of-way as in Concept 3.

Concept 5: Convert the south leg of Speen Street into a continuous-flow intersection (Figure 15).

A continuous-flow intersection allows opposing left turns and through movements to take place simultaneously using one signal controller at the main

intersection. For example, while east-west traffic on Route 30 is moving, northbound, left turns on Speen Street cross over oncoming traffic at a mid-block intersection. When the north-south signals on Speen Street turn green, both through and left-turn movements can go at the same time, because left-turn movement is already on the opposite side of the opposing through movement.

Concept 5 would reduce congestion at the Route 30/Speen Street intersection by servicing both through and left-turn movements at the same time. Concept 5 would have an impact in the area of right-of-way on the south leg of Speen Street. For efficient traffic operations, it is expected that in Concept 5 there would be two left-turn lanes, two through lanes in each direction, and an additional lane on the south leg of Speen Street to receive the high-volume of eastbound Route 30 right turns, which be a free-turn type. Currently, the AM and PM peak hour volumes for the eastbound Route 30 right turns are: 930 vehicles and 935 vehicles, respectively.

Considering the seven travel lanes in addition to median/traffic islands to separate or channel traffic, sidewalks, and utilities, the existing right-of-way (80 to 100 feet wide) would not be sufficient. More space on the south leg of Speen Street would therefore be needed to construct the improvements.

Table 6 presents results of the initial qualitative evaluation of the long-term concepts in terms of congestion reduction, access to businesses, and impacts on wetland, right-of-way, and aesthetics. MPO staff did not perform modeling and LOS analyses for the five long-term concepts because those tasks were not included in the work program for this study.

### Next Steps

The Route 30 and Speen Street intersection is the most critical intersection in the study area. Retiming this intersection would only provide short-term benefits, hence other strategies providing medium- and long-term benefits would be needed to address safety and traffic operations problems and provide relief to adjacent intersections.

A medium-term solution that adds a lane in the westbound direction from the TJX driveway to the MassPike on-ramp, which would be constructed as two lanes, was tested by MPO staff and found to improve intersection levels of service slightly but delays per vehicle and queues would be reduced by as much as 20% and 40%, respectively.

MPO staff recommends that the Towns of Framingham and Natick advance the long-term concepts toward further analysis and design by working closely with MassDOT to tie the medium- and long-term improvements at the Route 30 and Speen Street intersection with MassDOT's AET project.



**TABLE 6  
Comparison of Long-Term Concepts**

Concept Description	Impact on Access and Egress	Impact on Wetland	Constructability	Impact on Right-of-Way	Aesthetic/Visual Impacts	Impact on Traffic Operations	Cost
Concept 1—Speen Street over Route 30 (northbound and southbound)	Impacts access and egress to businesses on the north leg of Speen Street because of vertical clearance for landing the new bridge	Some wetland impacts. Grade separation of the northbound and southbound movements would require more space in the median of Speen Street to construct, which may impact adjacent wetland.	There is limited area on Speen Street for construction staging and traffic work zones, especially on the north leg.  Traffic management during construction could worsen congestion on Speen Street and Route 30.	Requires land takings on Speen Street. The width of the new bridge plus clearances and travel lanes to service other at-grade movements at the Route 30/Speen Street intersection would require more space on Speen Street to construct. On the south leg of Speen Street, the right-of-way varies from 80 feet in the Natick segment to 100 feet wide in the Framingham segment. On the north leg of Speen Street the right-of-way varies from about 40 feet to 90 feet wide.	Grade separation (overpass) presents aesthetics and visual impacts, as the aesthetic appeal of bridges is becoming increasingly important to people. Minimizing or preventing negative visual impacts because of new overpass is expected in this concept.	Would reduce congestion at Route 30 and Speen Street intersection. The new overpass will take the majority of the Speen Street through traffic out of the intersection. The savings in green time would be allocated to Route 30 and left turns on Speen Street to improve traffic operations.	High-cost improvement because of grade separation.
Concept 2—Grade-Separated Speen Street Northbound Left Turn and Route 30 Eastbound Exclusive Right Lanes.	Impacts access and egress to businesses in the northwest quadrant (Red Roof Inn, Sherwin William, Dunkin' Donuts, and Mobil) with driveways access on Route 30. Vertical clearance required for landing the new bridge would make access to those businesses very difficult. In addition, access on Speen Street to the Margaritas restaurant would be affected.	Minimal wetland impacts. In this concept, Speen Street northbound left turns would exit from the right hand side, which would reduce impact on wetland in the southwest quadrant of the intersection.	There is limited area for construction staging and traffic work zones on Speen Street and Route 30.  Traffic management during construction could worsen congestion on Speen Street and Route 30.	Requires land taking in the northwest and southeast quadrants. On the west leg of Route 30, the right-of-way is about 100 feet wide, while on the south leg of Speen Street the right-of-way varies from 80 feet wide in the Natick segment to 100 feet wide in the Framingham segment.	Grade separation (overpass) presents aesthetics and visual impacts, as the aesthetic appeal of bridges is becoming increasingly important to people. Minimizing or preventing negative visual impacts due to bridge is expected in this concept.	Require construction of a two-lane on-ramp to the MassPike to plaza to avoid a traffic merge on the westbound on-ramp.  Would reduce congestion at Route 30/ Speen Street intersection. The new overpass will take the majority of the high-volume Speen Street northbound lefts out of the intersection. The savings in green time would be allocated to Route 30 and Speen Street movements to improve traffic operations.	High-cost improvement because of grade separation.
Concept 3—Grade-Separated Median Left Turn from Speen Street Northbound to MassPike (eastbound and westbound)	Does not affect existing access and egress from businesses on Route 30 or Speen Street.  The grade separation is located in the median on the south leg of Speen Street. It connects to the MassPike in the northwest quadrant of Route 30 and Speen Street intersection to avoid negative impacts on access and egress to businesses.	Minimal wetland impacts, grade separation of the northbound left turn would require slightly more space in the median of Speen Street to construct, which may impact adjacent wetland.	Construction staging in the median of busy Speen Street may prove difficult because of limited space. In addition there is limited area on Speen Street for traffic work zones. Management of traffic during construction could worsen congestion on Route 30 and Speen Street.	Requires land takings in the northwest quadrant, which would affect properties of Red Roof Inn and the office building at 111 Speen Street. In addition, it would require land taking on the south leg of Speen Street; on the south leg of Speen Street the right-of-way varies from 80 feet wide in the Natick segment to 100 feet wide in the Framingham segment.	Grade-separation (overpass) presents aesthetics and visual impacts, as the aesthetic appeal of bridges is becoming increasingly important to people. Minimizing or preventing negative visual impacts because of new overpass is expected in this concept.	Connection to the MassPike may introduce a tight curve because of the alignment of the new ramp.  Traffic heading to MassPike westbound would have to weave across a travel lane, which could slow down traffic or create safety problems. With the all-electronic-toll system, traffic is expected to move faster and reduce congestion at the toll plaza.  Would reduce congestion at Route 30 and Speen Street intersection. The new overpass will take the majority of the high-volume Speen Street northbound lefts out of the intersection. The savings in green time would be allocated to Route 30 and Speen Street movements to improve traffic operations.	High-cost improvement because of grade separation.

Concept Description	Impact on Access and Egress	Impact on Wetland	Constructability	Impact on Right-of-Way	Aesthetic/Visual Impacts	Impact on Traffic Operations	Cost
Concept 4—Grade-Separated Median Left-Turn from Speen Street Northbound to MassPike (eastbound only)	Concept 4 is a variation of Concept 3 and it does not affect existing access and egress from businesses on Route 30 or Speen Street.	Minimal wetland impacts, grade separation of the northbound left turn would require slightly more space in the median to construct, which may impact adjacent wetland.	Construction staging in the median of busy Speen Street may prove difficult. In addition there is limited area for traffic work zones. Management of traffic during construction could worsen congestion on Route 30 and Speen Street.	Requires land takings in the northwest quadrant of Route 30 and Speen Street intersection, which may affect properties of Red Roof Inn and office building at 111 Speen Street. In addition, it would require land taking on the south leg of Speen Street; on the south leg of Speen Street the right-of-way varies from 80 feet wide in the Natick segment to 100 feet wide in the Framingham segment.	Grade separation (overpass) presents aesthetics and visual impacts, as the aesthetic appeal of bridges is becoming increasingly important to people. Minimizing or preventing negative visual impacts because of new overpass is expected in this concept.	<p>Connection to the MassPike may introduce a tight curve because of the alignment of the new ramp.</p> <p>Concept 4 avoids traffic weaving across to proceed to MassPike westbound; however, it would be difficult to prohibit/prevent motorists on the new ramp from doing so.</p> <p>Concept 4 may not reduce congestion at Route 30 and Speen Street intersection during the PM peak period; because about 50% of the northbound Speen Street left turn movement would be expected to head westbound on the MassPike during the PM peak period.</p>	High-cost improvement because of grade separation.
Concept 5—Continuous Flow Intersection on the South Leg of Speen Street	Would not impact access and egress to businesses at the Route 30 and Speen Street intersection because the improvement would be constructed only on the south leg of Speen Street.	Some wetland impacts; the improvement would require widening on the south leg of Speen Street in order to provide a free right turn for the high-volume Route 30 eastbound right turn movement.	Does not appear to present traffic management problems during construction, as the improvement involves mainly the reconfiguration of the Speen Street northbound left turn lanes by moving them to the left of the opposing through lanes.	Requires land takings along the south leg of Speen Street. For efficient operations, providing free right turns from Route 30 eastbound and maintaining proper alignment of the Speen Street through movements would require more space on the south leg of Speen Street.	Does not involve grade separation; all movements at the intersection will remain at-grade.	<p>Would reduce congestion at the Route 30 and Speen Street intersection because the Speen Street northbound left and through movements can be serviced at the same time.</p> <p>May result in a longer crosswalk on the south leg of Speen Street, which may affect pedestrians.</p>	Low-cost improvement, involves no grade separation.

Source: Central Transportation Planning Staff.

## 6.4 Cochituate Rail Trail (CRT) Crossing at Route 30

### 6.4.1 *Crossing Alternatives*

Four different crossing alternatives were analyzed as part of this study:

- Alternative 1: Trail users would cross Route 30 at the Speen Street intersection (Figure 16)
- Alternative 2: Trail users would cross Route 30 at the TJX Companies driveway intersection (Figure 16)
- Alternative 3: Trail users would cross Route 30 at the existing track alignment (Figure 17)
- Alternative 4: Trail users would cross Route 30 at the existing track alignment using grade separation (overpass or underpass) accessible to all trail users, including people with disabilities (Figure 17)

The first three alternatives were analyzed qualitatively in a CRT study conducted for the Town of Natick in 2009.<sup>9</sup> The detour diversion distances involved with Alternative 1 and Alternative 2 are 700 feet and 1150 feet, respectively.

### 6.4.2 *Impacts of Alternatives*

Trail usage counts are important for planning, especially for trail-highway crossings. The Boston Region MPO estimates trail usage based on the number of people living within one-half mile of the trail (population), the number of people who walk and bicycle in the community, the number and places of employment within a mile of the trail, and usage on other nearby trails. See Appendix F for the 2007 trail user counts on trails across Massachusetts. The Boston Region MPO projects that the CRT could generate about 100 trail users (all types of users combined) during peak hours on weekend day, and about 700 users per day. Table 7 presents safety impacts for trail users for each crossing alternative.

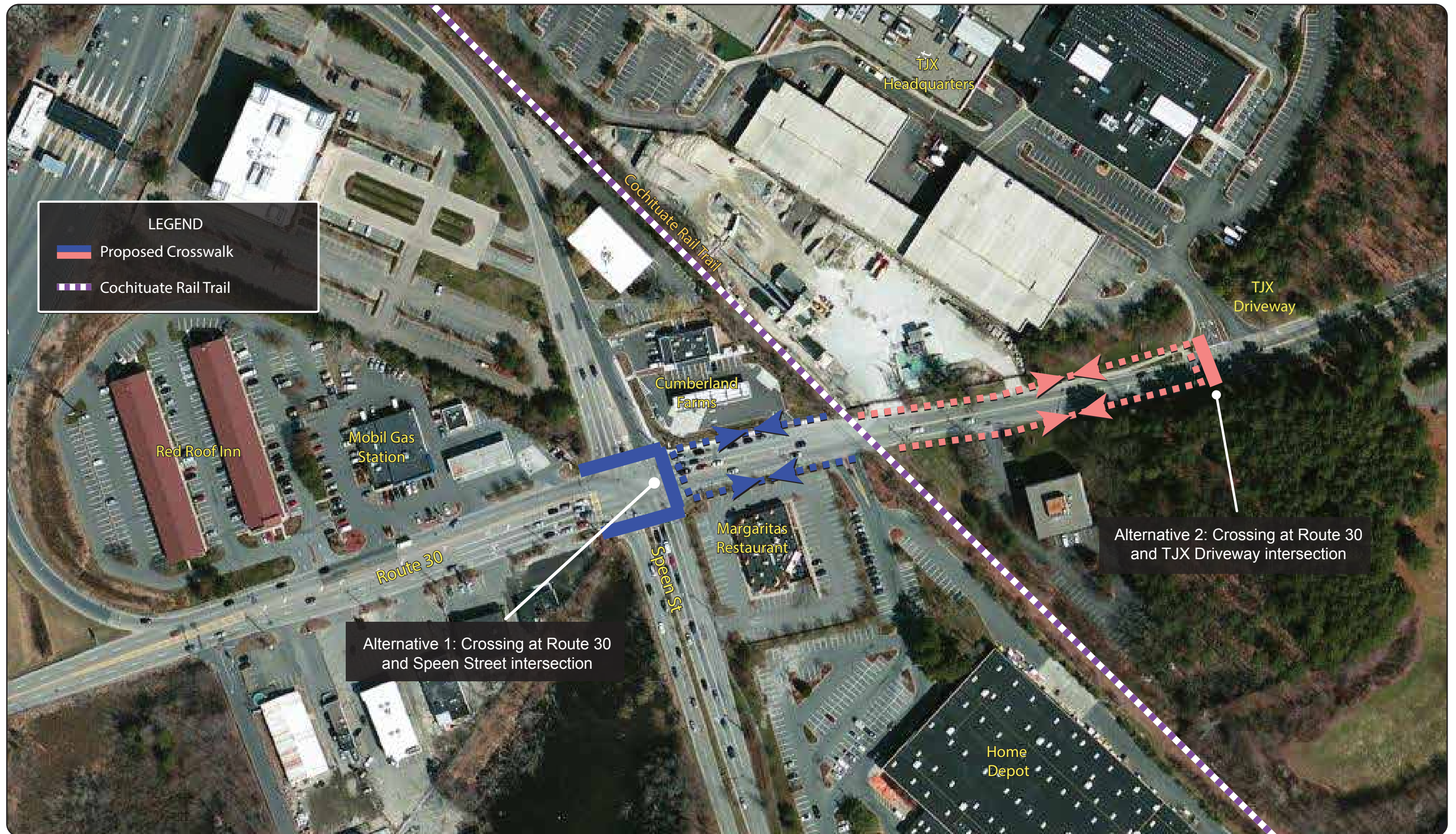
In summary, the notable safety impacts include but are not limited to:

- The lack of shoulders or bike lanes in the vicinity of the trail crossing would require bikers to walk their bikes to the intersections and share existing sidewalks with pedestrians.

---

<sup>9</sup> Town of Natick, MA, Cochituate Rail Trail, Conceptual Design Study, by Fay, Spofford & Thorndike, Draft November 2009.





**FIGURE 16**  
Cochituate Rail Trail Crossing at Route 30: Crossing Alternatives 1 and 2





**FIGURE 17**  
Cochituate Rail Trail Crossing at Route 30: Crossing Alternatives 3 and 4





- The large number of trail users that would be exposed to high-volume traffic on Route 30 and driveways in the vicinity could create safety problem for trail users.
- Recurring PM peak period traffic queues in the vicinity of the trail-highway crossing could affect sight distance and safety for trail users.
- Overhead wires in the vicinity of the existing tracks could pose problems for construction of a pedestrian bridge.
- Site conditions present challenges for people with disabilities and the elderly.

MPO staff analyzed the traffic operations impacts of each crossing alternative and the results of the analysis presented in Table 8.

#### 6.4.3 *Preferred Alternative*

MPO staff analyzed four crossing options to improve safety for trail users at the Route 30 crossing.

- Alternative 4 is the most effective and recommended by MPO staff, although it would be more expensive to install. If Alternative 4 is considered, the grade separation must be accessible for use by bicyclists and people with disabilities and be the appropriate height for trucks and other heavy vehicles (see insert above).
- Alternatives 1 and 2 are short-term and low-cost improvements but they are not effective. A potential difficulty with implementing Alternatives 1 and 2 would be channeling trail users to an intersection to avoid unsafe midblock crossing. In both alternatives, trail users would be diverted from the trail to an intersection and back to the trail for a total distance of 700 feet to 1,150 feet, which introduces significant delay for trail users.
- Alternative 3 is a short-term, medium-cost improvement and it provides trail users with a direct crossing along the path of the trail. Site conditions including long crosswalk, high traffic volumes, and traffic queues that could affect trail users' sight lines are some of the safety issues that make this alternative less effective compared to Alternative 4.



**TABLE 7**

**Cochituate Rail-Trail Crossing Alternatives: Impacts**

<b>Alternative</b>	<b>Operations and Safety Impacts</b>
Alternative 1: Crossing at Route 30 and Speen Street intersection	<ul style="list-style-type: none"> <li>• Does not follow pedestrian desire lines</li> <li>• Would have the greatest impact on traffic operations during peak periods</li> <li>• Home Depot, Margaritas, and Cumberland Farms driveways could pose problems for trail users</li> <li>• Bicyclists would need to walk their bikes to the intersection</li> </ul>
Alternative 2: Crossing at Route 30 and TJX driveway intersection	<ul style="list-style-type: none"> <li>• Does not follow pedestrian desire lines</li> <li>• Would pose lesser traffic operations impacts than Alternative 1</li> <li>• Bicyclists would need to walk their bikes to the intersection</li> </ul>
Alternative 3: A midblock crossing	<ul style="list-style-type: none"> <li>• Follows pedestrian desire lines</li> <li>• Would disrupt traffic on Route 30</li> <li>• No need to walk bicycles to and from an intersection</li> <li>• Midblock crossing is complicated by:                             <ul style="list-style-type: none"> <li>• Long crosswalk (crossing four to five travel lanes)</li> <li>• High volume of traffic on Route 30</li> </ul> </li> <li>• Home Depot driveway could prevent installation of a pedestrian hybrid beacon (HAWK signals)<sup>10</sup></li> </ul>
Alternative 4: Grade separation (overpass or underpass)	<ul style="list-style-type: none"> <li>• Follow pedestrian desire lines</li> <li>• No need to walk bicycles to and from an intersection</li> <li>• Would not interrupt traffic flow on Route 30</li> <li>• Overhead wires could pose problems for construction</li> <li>• Space required for construction—may require some land takings</li> </ul>

Source: Central Transportation Planning Staff.

<sup>10</sup> In reference to the [2009 Manual on Uniform Traffic Control Devices \(MUTCD\)](#), guidance in [Section 4F.02](#), when an engineering study finds that installation of a pedestrian hybrid beacon is justified, then: A: The pedestrian hybrid beacon should be installed at least 100 feet from side streets or driveways that are controlled by STOP or YIELD signs.

**TABLE 8**  
**Impacts of Trail Crossing Alternatives on Operations: Traffic Delay with and without CRT Trail Crossing**

<b>Alternative</b>	<b>Without Crossing (seconds per vehicle)</b>	<b>With Crossing (seconds per vehicle)</b>	<b>Change (seconds per vehicle)</b>	<b>Intersection Volume (vehicles)</b>	<b>Total Increase in Vehicle Delay (seconds)</b>
<b><i>AM Peak Hour Intersection Vehicle Delay:</i></b>	--	--	--	--	-
Alternative 1: Crossing at the TJX intersection	18	21	3	1970	5910
Alternative 2: Crossing at Speen Street intersection	97	120	23	4800	110,400
Alternative 3: Crossing at existing track alignment*	0	10	10	1970	19,700
Alternative 4: Crossing via grade separation	0	0	0	0	0
<b><i>PM Peak Hour Intersection Vehicle Delay:</i></b>	--	--	--	--	--
Alternative 1: Crossing at the TJX intersection	38	44	6	1720	10,320
Alternative 2: Crossing at Speen Street intersection	71	91	20	5020	100,400
Alternative 3: Crossing at existing track alignment*	0	9	9	1790	16,110
Alternative 4: Crossing via grade separation	0	0	0	0	0

\*Crossing at pedestrian-activated signal or beacon. CRT = Cochetuate Rail Trail.  
 Notes: 1) Analysis was conducted with existing traffic counts. 2) Pedestrian calls per hour = 20.  
 Source: Central Transportation Planning Staff.



Example of accessible pedestrian bridge (Arthur Fiedler Bridge, Boston)

## 7 SUMMARY, CONCLUSIONS, AND NEXT STEPS

The study of the Route 30 segment between the TJX driveway and the intersection at Ring Road/Shopper's World Way examined existing conditions and identified short- and long-term improvement concepts.

The main concerns in this segment relate to connections to the MassPike; peak hour delays and queues, especially at the Route 30/Speen Street intersection during the PM peak period; an incomplete network for bicyclist and pedestrian circulation, including crossing the Cochituate Rail Trail at Route 30, east of Speen Street; and congestion and safety concerns related to driveway access, including the TJX driveway.

The study identified three options for closing the gaps in the existing bicycle and pedestrian circulation, including recommendations for signs and markings; traffic signal retiming schemes at four signalized intersections; traffic management options for the Route 30 segment between Speen Street and the MassPike on-ramp; and, six medium- and long-term concepts for reconfiguring the connection of Speen Street and Route 30 to the MassPike, including adding a westbound traffic lane to Route 30 from the TJX driveway to the I-90 connector.

Long-term improvements in the studied Route 30 segment hinge upon improved regional connections between the MassPike and the local network that serves Framingham and Natick, and other municipalities. Examining the design and feasibility of various connection options of Route 30 and Speen Street to the MassPike is particularly timely. MassDOT is planning to remove the toll plazas throughout the MassPike by replacing them with MassDOT's All Electronic Tolling system. Connection options to I-90 from Framingham and Natick should be designed including the parameters and assumptions built into MassDOT's AET project.



SAA/saa

Encl.

cc: Paul Nelson, MassDOT Office of Transportation Planning

Joseph Frawley, MassDOT Highway Division, District 3

Jeremy Marsette, Town Engineer, Framingham

Patrick Reffett, Community Development Director, Natick

## **FIGURES**

Figure 1: Study Area Map

Figure 2: Land Use Map

Figure 3: Bicycle and Pedestrian Issues

Figure 4: Existing Peak-Hour Turning Movement Volumes

Figure 5: 2020 Peak-Hour Turning Movement Volumes

Figure 6: Option 1: Use Existing Sidewalks on Burr Street, Leggat McCall Connector Road, and Speen Street

Figure 7: Option 2: Continuous and Connected Sidewalks on South Side of Route 30

Figure 8: Option 3: Continuous and Connected Sidewalks/Multiuse Path on South Side of Route 30 and Outer Loop of MassPike Connector

Figure 9: Consolidate Driveways and Install Median Treatments Cochituate Rail Trail Crossing at Route 30: Crossing Alternatives

Figure 10: Medium-Term Concept: Add a Lane in the Westbound Direction of Route 30 from the TJX Entrance to the MassPike Westbound On-ramp

Figure 11: Concept 1: Speen Street Northbound and Southbound Through Movements over Route 30

Figure 12: Concept 2: Grade-Separated Speen Street Northbound Left Turn and Route 30 Eastbound Exclusive Double Right Turn Lanes

Figure 13: Concept 3: Grade-Separated Median Left Turn from Speen Street Northbound to MassPike (Eastbound and Westbound)

Figure 14: Concept 4: Grade Separated Median Left Turn from Speen Street Northbound to MassPike (Eastbound Only)

Figure 15: Concept 5: Continuous Flow Intersection (CFI)

Figure 16: Cochituate Rail Trail Crossing at Route 30: Crossing Alternatives 1 and 2

Figure 17: Cochituate Rail Trail Crossing at Route 30: Crossing Alternatives 3 and 4

**APPENDIXES**

Appendix A: Turning Movement and Automatic Traffic Recorder Counts

Appendix B: Traffic Signal Timing Information and As-Built Traffic Signal Plans

Appendix C: Crash Rates Worksheets and Collision Diagrams

Appendix D: Intersection Capacity and Levels of Service Analyses

Appendix E: Mitigation Improvements and Actions for Route 30

Appendix F: Trail User Counts on various Trails in Massachusetts

# **Appendix A: Turning Movement and Automatic Traffic Recorder Counts**





# Massachusetts Department of Transportation-Highway Division

## Statewide Traffic Data Collection

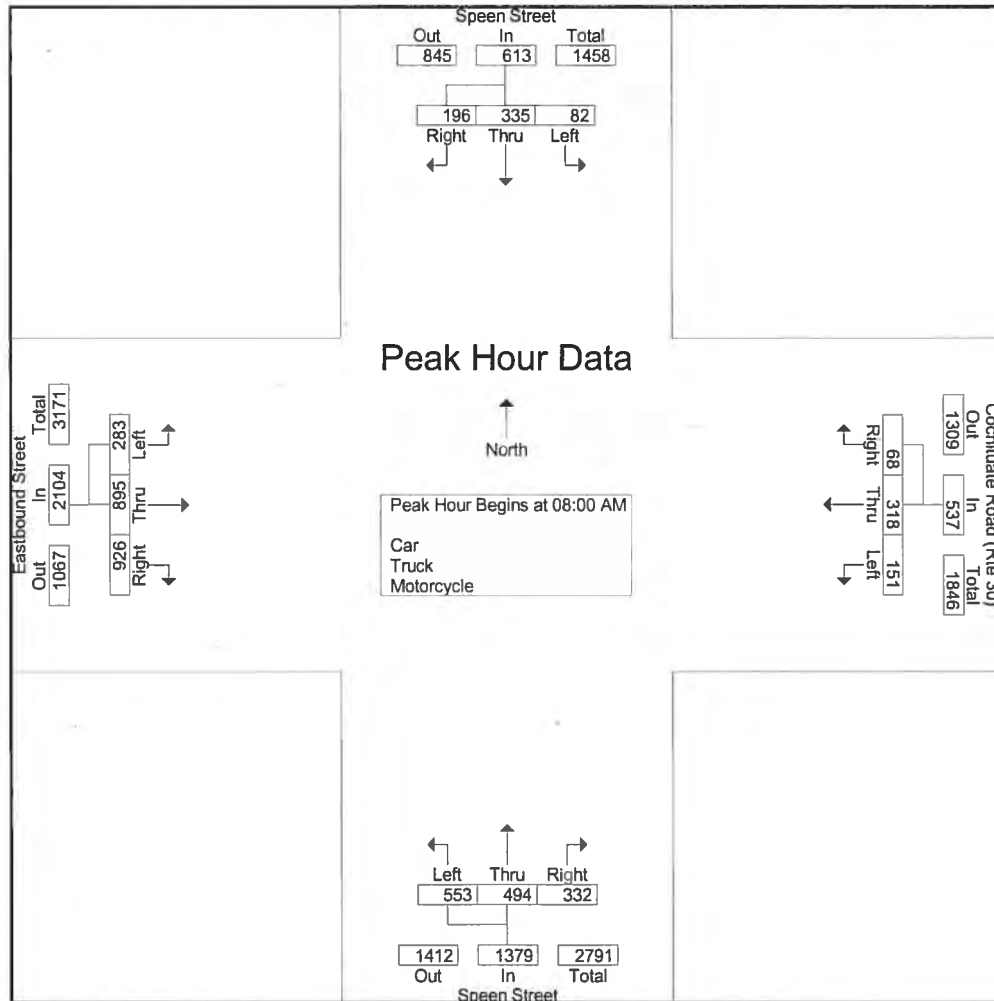
File Name : S12-078TM4

Site Code : 86815

Start Date : 11/29/2012

Page No : 2

Start Time	Speen Street From North				Cochituate Road (Rte 30) From East				Speen Street From South				Eastbound Street From West				Int. Total
	Right	Thru	Left	App. Total	Right	Thru	Left	App. Total	Right	Thru	Left	App. Total	Right	Thru	Left	App. Total	
Peak Hour Analysis From 07:00 AM to 11:45 AM - Peak 1 of 1																	
Peak Hour for Entire Intersection Begins at 08:00 AM																	
08:00 AM	58	84	24	166	13	75	34	122	70	91	168	329	226	223	71	520	1137
08:15 AM	44	91	22	157	13	72	43	128	71	135	121	327	245	196	60	501	1113
08:30 AM	44	80	23	147	18	93	40	151	79	136	143	358	237	219	59	515	1171
08:45 AM	50	80	13	143	24	78	34	136	112	132	121	365	218	257	93	568	1212
Total Volume	196	335	82	613	68	318	151	537	332	494	553	1379	926	895	283	2104	4633
% App. Total	32	54.6	13.4		12.7	59.2	28.1		24.1	35.8	40.1		44	42.5	13.5		
PHF	.845	.920	.854	.923	.708	.855	.878	.889	.741	.908	.823	.945	.945	.871	.761	.926	.956

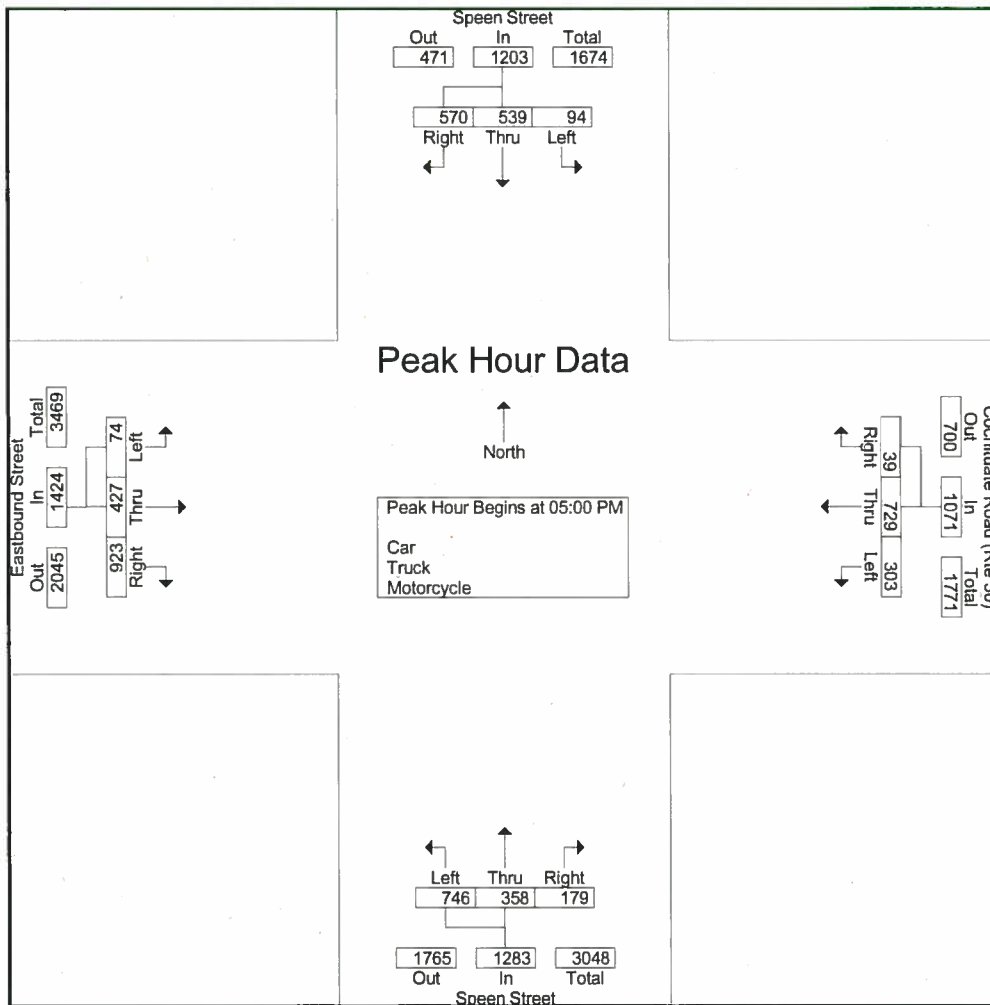


# Massachusetts Department of Transportation-Highway Division

## Statewide Traffic Data Collection

File Name : S12-078TM4  
 Site Code : 86815  
 Start Date : 11/29/2012  
 Page No : 3

Start Time	Speen Street From North				Cochituate Road (Rte 30) From East				Speen Street From South				Eastbound Street From West				Int. Total
	Right	Thru	Left	App. Total	Right	Thru	Left	App. Total	Right	Thru	Left	App. Total	Right	Thru	Left	App. Total	
Peak Hour Analysis From 12:00 PM to 05:45 PM - Peak 1 of 1																	
Peak Hour for Entire Intersection Begins at 05:00 PM																	
05:00 PM	150	112	25	287	10	209	74	293	45	89	205	339	212	100	20	332	1251
05:15 PM	157	128	28	313	10	187	86	283	41	71	173	285	245	120	19	384	1265
05:30 PM	158	150	27	335	10	165	65	240	45	104	207	356	232	102	17	351	1282
05:45 PM	105	149	14	268	9	168	78	255	48	94	161	303	234	105	18	357	1183
<b>Total Volume</b>	570	539	94	1203	39	729	303	1071	179	358	746	1283	923	427	74	1424	4981
<b>% App. Total</b>	47.4	44.8	7.8		3.6	68.1	28.3		14	27.9	58.1		64.8	30	5.2		
PHF	.902	.898	.839	.898	.975	.872	.881	.914	.932	.861	.901	.901	.942	.890	.925	.927	.971





# Massachusetts Department of Transportation-Highway Division

Statewide Traffic Data Collection

Framingham  
Route 30 at Speen Street  
Counted by Miovision  
S12-078 TMC # 4

File Name : S12-078TM4  
Site Code : 86815  
Start Date : 11/29/2012  
Page No : 1

Groups Printed- Car

Start Time	Speen Street From North				Cochituate Road (Rte 30) From East				Speen Street From South				Eastbound Street From West				Int. Total
	Right	Thru	Left	App. Total	Right	Thru	Left	App. Total	Right	Thru	Left	App. Total	Right	Thru	Left	App. Total	
07:00 AM	82	75	29	186	5	48	17	70	53	71	185	309	111	129	29	269	834
07:15 AM	108	57	20	185	6	63	25	94	69	77	190	336	98	161	18	277	892
07:30 AM	79	77	17	173	5	70	23	98	78	88	147	313	122	151	49	322	906
07:45 AM	56	100	16	172	9	60	25	94	83	122	172	377	177	159	44	380	1023
<b>Total</b>	<b>325</b>	<b>309</b>	<b>82</b>	<b>716</b>	<b>25</b>	<b>241</b>	<b>90</b>	<b>356</b>	<b>283</b>	<b>358</b>	<b>694</b>	<b>1335</b>	<b>508</b>	<b>600</b>	<b>140</b>	<b>1248</b>	<b>3655</b>
08:00 AM	57	84	24	165	13	71	30	114	66	90	162	318	217	212	71	500	1097
08:15 AM	44	89	20	153	13	72	41	126	70	132	113	315	242	193	60	495	1089
08:30 AM	41	75	22	138	18	91	37	146	76	132	136	344	232	212	59	503	1131
08:45 AM	49	79	13	141	23	76	34	133	108	129	117	354	216	253	92	561	1189
<b>Total</b>	<b>191</b>	<b>327</b>	<b>79</b>	<b>597</b>	<b>67</b>	<b>310</b>	<b>142</b>	<b>519</b>	<b>320</b>	<b>483</b>	<b>528</b>	<b>1331</b>	<b>907</b>	<b>870</b>	<b>282</b>	<b>2059</b>	<b>4506</b>
04:00 PM	100	98	16	214	8	152	77	237	39	72	183	294	195	107	25	327	1072
04:15 PM	83	84	23	190	13	131	60	204	42	68	211	321	186	107	26	319	1034
04:30 PM	126	134	13	273	8	137	64	209	28	90	188	306	196	78	24	298	1086
04:45 PM	134	110	15	259	16	177	64	257	36	97	195	328	194	107	14	315	1159
<b>Total</b>	<b>443</b>	<b>426</b>	<b>67</b>	<b>936</b>	<b>45</b>	<b>597</b>	<b>265</b>	<b>907</b>	<b>145</b>	<b>327</b>	<b>777</b>	<b>1249</b>	<b>771</b>	<b>399</b>	<b>89</b>	<b>1259</b>	<b>4351</b>
05:00 PM	150	111	24	285	10	206	74	290	45	88	202	335	210	100	20	330	1240
05:15 PM	156	128	28	312	10	185	86	281	41	70	170	281	245	120	19	384	1258
05:30 PM	158	148	27	333	9	164	63	236	45	104	204	353	231	100	16	347	1269
05:45 PM	104	148	14	266	9	168	78	255	48	94	159	301	231	105	17	353	1175
<b>Total</b>	<b>568</b>	<b>535</b>	<b>93</b>	<b>1196</b>	<b>38</b>	<b>723</b>	<b>301</b>	<b>1062</b>	<b>179</b>	<b>356</b>	<b>735</b>	<b>1270</b>	<b>917</b>	<b>425</b>	<b>72</b>	<b>1414</b>	<b>4942</b>
<b>Grand Total</b>	<b>1527</b>	<b>1597</b>	<b>321</b>	<b>3445</b>	<b>175</b>	<b>1871</b>	<b>798</b>	<b>2844</b>	<b>927</b>	<b>1524</b>	<b>2734</b>	<b>5185</b>	<b>3103</b>	<b>2294</b>	<b>583</b>	<b>5980</b>	<b>17454</b>
Apprch %	44.3	46.4	9.3		6.2	65.8	28.1		17.9	29.4	52.7		51.9	38.4	9.7		
Total %	8.7	9.1	1.8	19.7	1	10.7	4.6	16.3	5.3	8.7	15.7	29.7	17.8	13.1	3.3	34.3	

# Massachusetts Department of Transportation-Highway Division

Statewide Traffic Data Collection

Framingham  
 Route 30 at Speen Street  
 Counted by Miovision  
 S12-078 TMC # 4

File Name : S12-078TM4  
 Site Code : 86815  
 Start Date : 11/29/2012  
 Page No : 1

Groups Printed- Truck

Start Time	Speen Street From North				Cochituate Road (Rte 30) From East				Speen Street From South				Eastbound Street From West				Int. Total
	Right	Thru	Left	App. Total	Right	Thru	Left	App. Total	Right	Thru	Left	App. Total	Right	Thru	Left	App. Total	
07:00 AM	0	1	0	1	0	3	0	3	2	2	3	7	8	3	0	11	22
07:15 AM	0	0	0	0	0	1	0	1	3	5	4	12	8	3	0	11	24
07:30 AM	2	3	0	5	0	1	1	2	1	0	5	6	5	6	0	11	24
07:45 AM	0	6	1	7	1	3	0	4	2	3	6	11	5	5	2	12	34
Total	2	10	1	13	1	8	1	10	8	10	18	36	26	17	2	45	104
08:00 AM	1	0	0	1	0	4	4	8	4	1	6	11	9	11	0	20	40
08:15 AM	0	2	2	4	0	0	2	2	1	3	8	12	3	3	0	6	24
08:30 AM	3	5	1	9	0	2	3	5	3	4	7	14	5	7	0	12	40
08:45 AM	1	1	0	2	1	2	0	3	4	3	4	11	2	4	1	7	23
Total	5	8	3	16	1	8	9	18	12	11	25	48	19	25	1	45	127
04:00 PM	1	1	0	2	1	4	4	9	1	0	2	3	7	2	0	9	23
04:15 PM	2	5	3	10	0	6	1	7	0	0	2	2	4	0	0	4	23
04:30 PM	2	3	0	5	0	3	2	5	1	2	2	5	2	5	0	7	22
04:45 PM	0	2	0	2	1	2	1	4	1	0	6	7	4	0	0	4	17
Total	5	11	3	19	2	15	8	25	3	2	12	17	17	7	0	24	85
05:00 PM	0	1	1	2	0	3	0	3	0	1	3	4	2	0	0	2	11
05:15 PM	1	0	0	1	0	2	0	2	0	1	3	4	0	0	0	0	7
05:30 PM	0	2	0	2	1	1	2	4	0	0	3	3	1	2	1	4	13
05:45 PM	1	1	0	2	0	0	0	0	0	0	2	2	3	0	1	4	8
Total	2	4	1	7	1	6	2	9	0	2	11	13	6	2	2	10	39
Grand Total	14	33	8	55	5	37	20	62	23	25	66	114	68	51	5	124	355
Apprch %	25.5	60	14.5		8.1	59.7	32.3		20.2	21.9	57.9		54.8	41.1	4		
Total %	3.9	9.3	2.3	15.5	1.4	10.4	5.6	17.5	6.5	7	18.6	32.1	19.2	14.4	1.4	34.9	

# Massachusetts Department of Transportation-Highway Division

Statewide Traffic Data Collection

Framingham  
 Route 30 at Speen Street  
 Counted by Miovision  
 S12-078 TMC # 4

File Name : S12-078TM4  
 Site Code : 86815  
 Start Date : 11/29/2012  
 Page No : 1

Groups Printed- Motorcycle

Start Time	Speen Street From North				Cochituate Road (Rte 30) From East				Speen Street From South				Eastbound Street From West				Int. Total
	Right	Thru	Left	App. Total	Right	Thru	Left	App. Total	Right	Thru	Left	App. Total	Right	Thru	Left	App. Total	
04:15 PM	0	0	0	0	0	0	0	0	0	0	0	0	0	1	0	1	1
Total	0	0	0	0	0	0	0	0	0	0	0	0	0	1	0	1	1
Grand Total	0	0	0	0	0	0	0	0	0	0	0	0	0	1	0	1	1
Apprch %	0	0	0		0	0	0		0	0	0		0	100	0		
Total %	0	0	0		0	0	0		0	0	0		0	100	0	100	



# Massachusetts Department of Transportation-Highway Division

Statewide Traffic Data Collection

Framingham  
Route 30 at Speen Street  
Counted by Miovision  
S12-078 TMC # 4

File Name : S12-078TM4  
Site Code : 86815  
Start Date : 11/29/2012  
Page No : 1

Groups Printed- People

Start Time	Speen Street From North		Cochituate Road (Rte 30) From East		Speen Street From South		Eastbound Street From West		Int. Total
	Peds	App. Total	Peds	App. Total	Peds	App. Total	Peds	App. Total	
08:30 AM	0	0	0	0	1	1	1	1	2
08:45 AM	1	1	1	1	0	0	0	0	2
Total	1	1	1	1	1	1	1	1	4
04:00 PM	0	0	1	1	0	0	0	0	1
04:30 PM	0	0	0	0	1	1	1	1	2
04:45 PM	0	0	1	1	0	0	0	0	1
Total	0	0	2	2	1	1	1	1	4
Grand Total	1	1	3	3	2	2	2	2	8
Apprch %	100		100		100		100		
Total %	12.5	12.5	37.5	37.5	25	25	25	25	



# Massachusetts Department of Transportation-Highway Division

Statewide Traffic Data Collection

Framingham  
Route 30 at Burr Street  
Counted by Miovision  
S12-078 TMC # 3

File Name : S12-078TM3  
Site Code : 86814  
Start Date : 11/29/2012  
Page No : 1

Groups Printed- Car - Truck - Motorcycle

Start Time	Burr Street From North				Cochituate Road From East				Burr Street From South				Cochituate Road From West				Int. Total
	Right	Thru	Left	App. Total	Right	Thru	Left	App. Total	Right	Thru	Left	App. Total	Right	Thru	Left	App. Total	
07:00 AM	1	2	25	28	71	158	0	229	52	8	0	60	0	267	15	282	599
07:15 AM	1	4	10	15	71	202	0	273	74	10	0	84	1	297	18	316	688
07:30 AM	2	2	23	27	103	211	0	314	57	4	0	61	0	234	14	248	650
07:45 AM	6	6	25	37	161	270	1	432	58	21	0	79	0	249	25	274	822
<b>Total</b>	<b>10</b>	<b>14</b>	<b>83</b>	<b>107</b>	<b>406</b>	<b>841</b>	<b>1</b>	<b>1248</b>	<b>241</b>	<b>43</b>	<b>0</b>	<b>284</b>	<b>1</b>	<b>1047</b>	<b>72</b>	<b>1120</b>	<b>2759</b>
08:00 AM	2	8	25	35	187	229	0	416	41	8	0	49	1	196	39	236	736
08:15 AM	3	3	21	27	225	263	0	488	37	20	1	58	2	184	24	210	783
08:30 AM	5	8	19	32	282	264	1	547	44	18	0	62	1	155	28	184	825
08:45 AM	8	6	14	28	313	234	2	549	33	28	2	63	1	171	49	221	861
<b>Total</b>	<b>18</b>	<b>25</b>	<b>79</b>	<b>122</b>	<b>1007</b>	<b>990</b>	<b>3</b>	<b>2000</b>	<b>155</b>	<b>74</b>	<b>3</b>	<b>232</b>	<b>5</b>	<b>706</b>	<b>140</b>	<b>851</b>	<b>3205</b>
04:00 PM	23	14	80	117	50	263	0	313	104	17	3	124	5	227	18	250	804
04:15 PM	27	15	53	95	63	300	1	364	96	14	4	114	1	223	14	238	811
04:30 PM	8	17	100	125	55	302	3	360	95	21	3	119	2	256	29	287	891
04:45 PM	18	6	79	103	66	314	0	380	97	20	5	122	3	226	27	256	861
<b>Total</b>	<b>76</b>	<b>52</b>	<b>312</b>	<b>440</b>	<b>234</b>	<b>1179</b>	<b>4</b>	<b>1417</b>	<b>392</b>	<b>72</b>	<b>15</b>	<b>479</b>	<b>11</b>	<b>932</b>	<b>88</b>	<b>1031</b>	<b>3367</b>
05:00 PM	10	6	138	154	54	320	1	375	118	13	3	134	5	256	13	274	937
05:15 PM	16	18	101	135	66	333	0	399	116	15	4	135	4	235	21	260	929
05:30 PM	24	15	117	156	62	319	0	381	74	13	0	87	4	247	18	269	893
05:45 PM	20	15	99	134	98	352	1	451	77	21	3	101	5	182	27	214	900
<b>Total</b>	<b>70</b>	<b>54</b>	<b>455</b>	<b>579</b>	<b>280</b>	<b>1324</b>	<b>2</b>	<b>1606</b>	<b>385</b>	<b>62</b>	<b>10</b>	<b>457</b>	<b>18</b>	<b>920</b>	<b>79</b>	<b>1017</b>	<b>3659</b>
<b>Grand Total</b>	<b>174</b>	<b>145</b>	<b>929</b>	<b>1248</b>	<b>1927</b>	<b>4334</b>	<b>10</b>	<b>6271</b>	<b>1173</b>	<b>251</b>	<b>28</b>	<b>1452</b>	<b>35</b>	<b>3605</b>	<b>379</b>	<b>4019</b>	<b>12990</b>
Apprch %	13.9	11.6	74.4		30.7	69.1	0.2		80.8	17.3	1.9		0.9	89.7	9.4		
Total %	1.3	1.1	7.2	9.6	14.8	33.4	0.1	48.3	9	1.9	0.2	11.2	0.3	27.8	2.9	30.9	
Car	170	145	924	1239	1908	4226	10	6144	1155	248	28	1431	34	3526	376	3936	12750
% Car	97.7	100	99.5	99.3	99	97.5	100	98	98.5	98.8	100	98.6	97.1	97.8	99.2	97.9	98.2
Truck	4	0	5	9	19	107	0	126	18	3	0	21	1	78	3	82	238
% Truck	2.3	0	0.5	0.7	1	2.5	0	2	1.5	1.2	0	1.4	2.9	2.2	0.8	2	1.8
Motorcycle	0	0	0	0	0	1	0	1	0	0	0	0	0	1	0	1	2
% Motorcycle	0	0	0	0	0	0	0	0	0	0	0	0	0	0	0	0	0

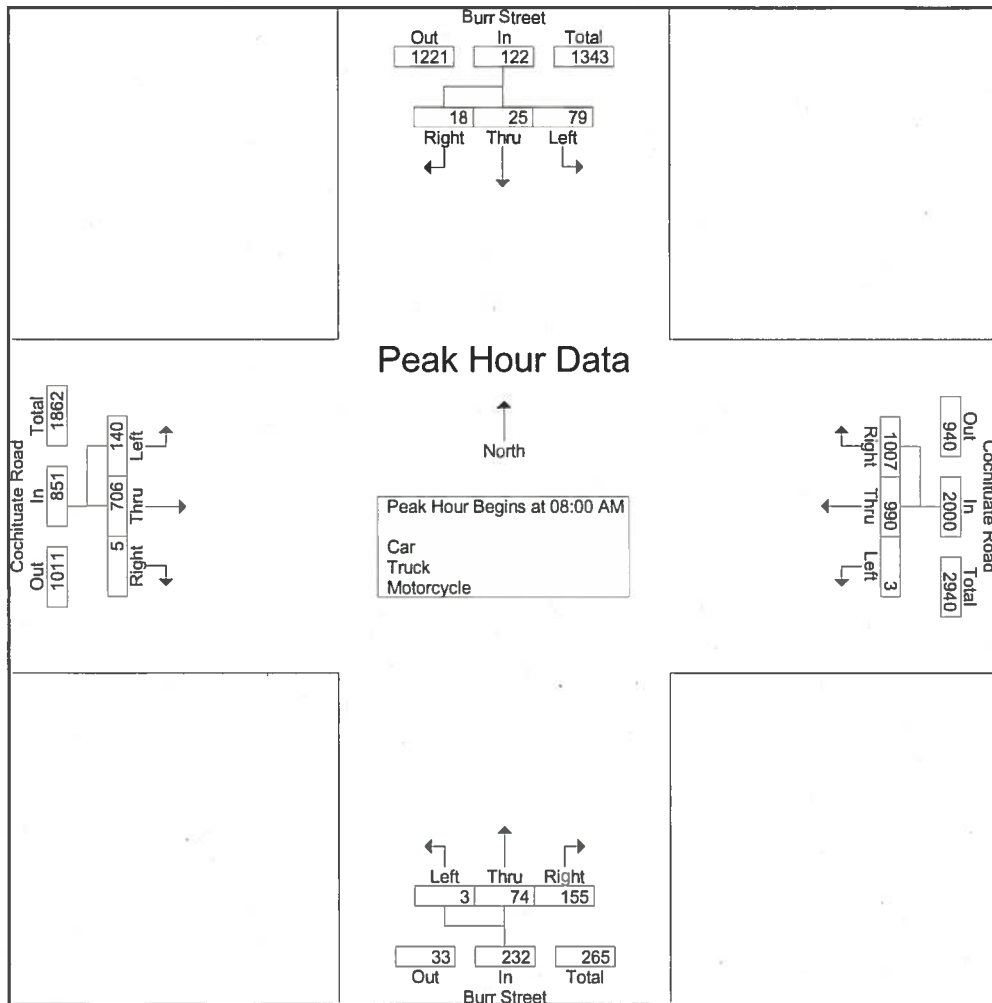


# Massachusetts Department of Transportation-Highway Division

## Statewide Traffic Data Collection

File Name : S12-078TM3  
 Site Code : 86814  
 Start Date : 11/29/2012  
 Page No : 2

Start Time	Burr Street From North				Cochituate Road From East				Burr Street From South				Cochituate Road From West				Int. Total
	Right	Thru	Left	App. Total	Right	Thru	Left	App. Total	Right	Thru	Left	App. Total	Right	Thru	Left	App. Total	
Peak Hour Analysis From 07:00 AM to 11:45 AM - Peak 1 of 1																	
Peak Hour for Entire Intersection Begins at 08:00 AM																	
08:00 AM	2	8	25	35	187	229	0	416	41	8	0	49	1	196	39	236	736
08:15 AM	3	3	21	27	225	263	0	488	37	20	1	58	2	184	24	210	783
08:30 AM	5	8	19	32	282	264	1	547	44	18	0	62	1	155	28	184	825
08:45 AM	8	6	14	28	313	234	2	549	33	28	2	63	1	171	49	221	861
Total Volume	18	25	79	122	1007	990	3	2000	155	74	3	232	5	706	140	851	3205
% App. Total	14.8	20.5	64.8		50.3	49.5	0.2		66.8	31.9	1.3		0.6	83	16.5		
PHF	.563	.781	.790	.871	.804	.938	.375	.911	.881	.661	.375	.921	.625	.901	.714	.901	.931

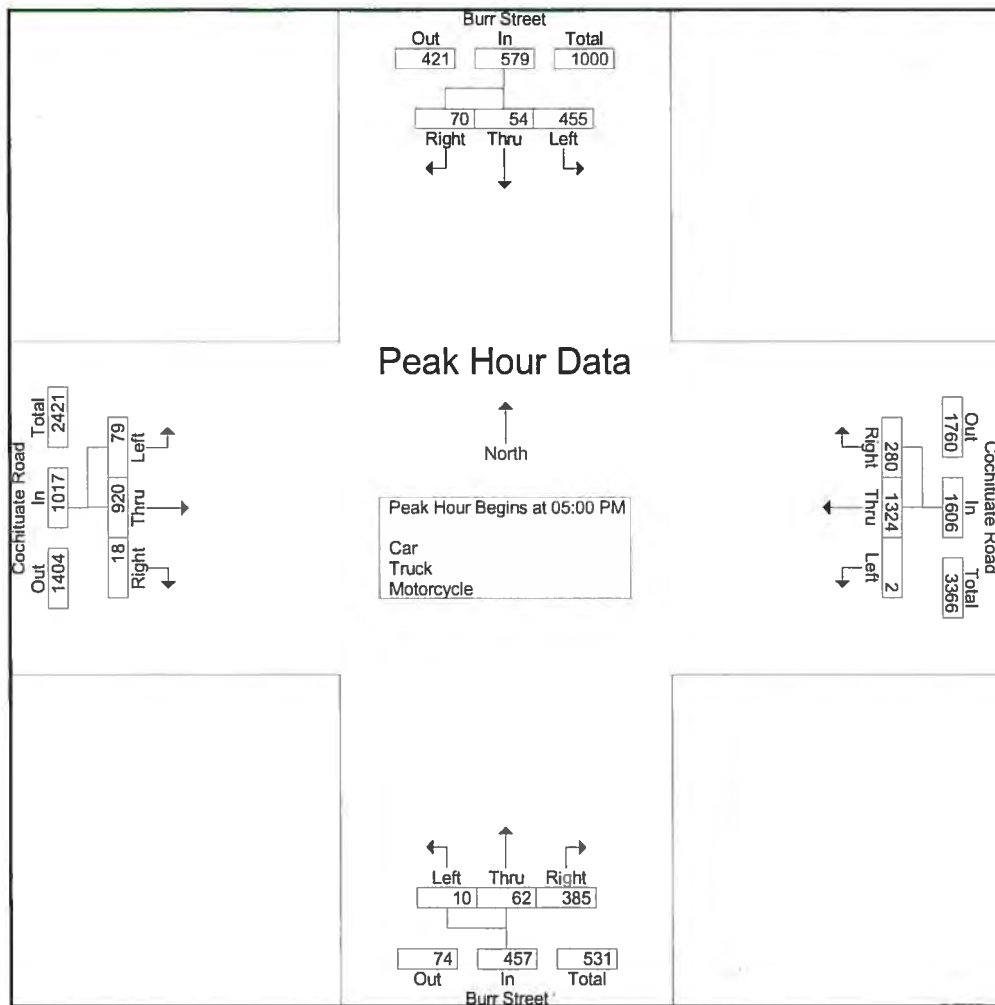


# Massachusetts Department of Transportation-Highway Division

## Statewide Traffic Data Collection

File Name : S12-078TM3  
 Site Code : 86814  
 Start Date : 11/29/2012  
 Page No : 3

Start Time	Burr Street From North				Cochituate Road From East				Burr Street From South				Cochituate Road From West				Int. Total
	Right	Thru	Left	App. Total	Right	Thru	Left	App. Total	Right	Thru	Left	App. Total	Right	Thru	Left	App. Total	
Peak Hour Analysis From 12:00 PM to 05:45 PM - Peak 1 of 1																	
Peak Hour for Entire Intersection Begins at 05:00 PM																	
05:00 PM	10	6	138	154	54	320	1	375	118	13	3	134	5	256	13	274	937
05:15 PM	16	18	101	135	66	333	0	399	116	15	4	135	4	235	21	260	929
05:30 PM	24	15	117	156	62	319	0	381	74	13	0	87	4	247	18	269	893
05:45 PM	20	15	99	134	98	352	1	451	77	21	3	101	5	182	27	214	900
Total Volume	70	54	455	579	280	1324	2	1606	385	62	10	457	18	920	79	1017	3659
% App. Total	12.1	9.3	78.6		17.4	82.4	0.1		84.2	13.6	2.2		1.8	90.5	7.8		
PHF	.729	.750	.824	.928	.714	.940	.500	.890	.816	.738	.625	.846	.900	.898	.731	.928	.976



# Massachusetts Department of Transportation-Highway Division

Statewide Traffic Data Collection

Framingham  
Route 30 at Burr Street  
Counted by Miovision  
S12-078 TMC # 3

File Name : S12-078TM3  
Site Code : 86814  
Start Date : 11/29/2012  
Page No : 1

Groups Printed- Car

Start Time	Burr Street From North				Cochituate Road From East				Burr Street From South				Cochituate Road From West				Int. Total
	Right	Thru	Left	App. Total	Right	Thru	Left	App. Total	Right	Thru	Left	App. Total	Right	Thru	Left	App. Total	
07:00 AM	1	2	25	28	69	152	0	221	52	8	0	60	0	259	15	274	583
07:15 AM	1	4	9	14	71	193	0	264	74	10	0	84	1	295	17	313	675
07:30 AM	2	2	23	27	101	205	0	306	52	3	0	55	0	226	14	240	628
07:45 AM	6	6	25	37	158	263	1	422	58	21	0	79	0	235	25	260	798
Total	10	14	82	106	399	813	1	1213	236	42	0	278	1	1015	71	1087	2684
08:00 AM	0	8	23	31	185	216	0	401	41	8	0	49	1	187	38	226	707
08:15 AM	3	3	20	26	222	251	0	473	37	19	1	57	2	181	24	207	763
08:30 AM	5	8	19	32	281	251	1	533	41	18	0	59	1	145	28	174	798
08:45 AM	8	6	14	28	312	229	2	543	33	28	2	63	1	167	48	216	850
Total	16	25	76	117	1000	947	3	1950	152	73	3	228	5	680	138	823	3118
04:00 PM	23	14	79	116	50	261	0	311	101	17	3	121	5	222	18	245	793
04:15 PM	26	15	53	94	60	286	1	347	94	14	4	112	1	219	14	234	787
04:30 PM	8	17	100	125	55	300	3	358	92	21	3	116	2	253	29	284	883
04:45 PM	18	6	79	103	65	309	0	374	96	19	5	120	2	224	27	253	850
Total	75	52	311	438	230	1156	4	1390	383	71	15	469	10	918	88	1016	3313
05:00 PM	9	6	138	153	54	318	1	373	117	13	3	133	5	255	13	273	932
05:15 PM	16	18	101	135	66	329	0	395	116	15	4	135	4	234	21	259	924
05:30 PM	24	15	117	156	62	316	0	378	74	13	0	87	4	244	18	266	887
05:45 PM	20	15	99	134	97	347	1	445	77	21	3	101	5	180	27	212	892
Total	69	54	455	578	279	1310	2	1591	384	62	10	456	18	913	79	1010	3635
Grand Total	170	145	924	1239	1908	4226	10	6144	1155	248	28	1431	34	3526	376	3936	12750
Apprch %	13.7	11.7	74.6		31.1	68.8	0.2		80.7	17.3	2		0.9	89.6	9.6		
Total %	1.3	1.1	7.2	9.7	15	33.1	0.1	48.2	9.1	1.9	0.2	11.2	0.3	27.7	2.9	30.9	



# Massachusetts Department of Transportation-Highway Division

Statewide Traffic Data Collection

Framingham  
 Route 30 at Burr Street  
 Counted by Miovision  
 S12-078 TMC # 3

File Name : S12-078TM3  
 Site Code : 86814  
 Start Date : 11/29/2012  
 Page No : 1

Groups Printed- Truck

Start Time	Burr Street From North				Cochituate Road From East				Burr Street From South				Cochituate Road From West				Int. Total
	Right	Thru	Left	App. Total	Right	Thru	Left	App. Total	Right	Thru	Left	App. Total	Right	Thru	Left	App. Total	
07:00 AM	0	0	0	0	2	6	0	8	0	0	0	0	0	8	0	8	16
07:15 AM	0	0	1	1	0	9	0	9	0	0	0	0	0	2	1	3	13
07:30 AM	0	0	0	0	2	6	0	8	5	1	0	6	0	8	0	8	22
07:45 AM	0	0	0	0	3	7	0	10	0	0	0	0	0	14	0	14	24
Total	0	0	1	1	7	28	0	35	5	1	0	6	0	32	1	33	75
08:00 AM	2	0	2	4	2	13	0	15	0	0	0	0	0	9	1	10	29
08:15 AM	0	0	1	1	3	12	0	15	0	1	0	1	0	3	0	3	20
08:30 AM	0	0	0	0	1	13	0	14	3	0	0	3	0	10	0	10	27
08:45 AM	0	0	0	0	1	5	0	6	0	0	0	0	0	4	1	5	11
Total	2	0	3	5	7	43	0	50	3	1	0	4	0	26	2	28	87
04:00 PM	0	0	1	1	0	2	0	2	3	0	0	3	0	5	0	5	11
04:15 PM	1	0	0	1	3	14	0	17	2	0	0	2	0	3	0	3	23
04:30 PM	0	0	0	0	0	2	0	2	3	0	0	3	0	3	0	3	8
04:45 PM	0	0	0	0	1	5	0	6	1	1	0	2	1	2	0	3	11
Total	1	0	1	2	4	23	0	27	9	1	0	10	1	13	0	14	53
05:00 PM	1	0	0	1	0	2	0	2	1	0	0	1	0	1	0	1	5
05:15 PM	0	0	0	0	0	4	0	4	0	0	0	0	0	1	0	1	5
05:30 PM	0	0	0	0	0	2	0	2	0	0	0	0	0	3	0	3	5
05:45 PM	0	0	0	0	1	5	0	6	0	0	0	0	0	2	0	2	8
Total	1	0	0	1	1	13	0	14	1	0	0	1	0	7	0	7	23
Grand Total	4	0	5	9	19	107	0	126	18	3	0	21	1	78	3	82	238
Apprch %	44.4	0	55.6		15.1	84.9	0		85.7	14.3	0		1.2	95.1	3.7		
Total %	1.7	0	2.1	3.8	8	45	0	52.9	7.6	1.3	0	8.8	0.4	32.8	1.3	34.5	

*Massachusetts Department of Transportation-Highway Division*  
Statewide Traffic Data Collection

Framingham  
Route 30 at Burr Street  
Counted by Miovision  
S12-078 TMC # 3

File Name : S12-078TM3  
Site Code : 86814  
Start Date : 11/29/2012  
Page No : 1

Groups Printed- Motorcycle

Start Time	Burr Street From North				Cochituate Road -From East				Burr Street From South				Cochituate Road From West				Int. Total
	Right	Thru	Left	App. Total	Right	Thru	Left	App. Total	Right	Thru	Left	App. Total	Right	Thru	Left	App. Total	
04:15 PM	0	0	0	0	0	0	0	0	0	0	0	0	0	1	0	1	1
Total	0	0	0	0	0	0	0	0	0	0	0	0	0	1	0	1	1
05:30 PM	0	0	0	0	0	1	0	1	0	0	0	0	0	0	0	0	1
Total	0	0	0	0	0	1	0	1	0	0	0	0	0	0	0	0	1
Grand Total	0	0	0	0	0	1	0	1	0	0	0	0	0	1	0	1	2
Apprch %	0	0	0		0	100	0		0	0	0		0	100	0		
Total %	0	0	0		0	50	0	50	0	0	0		0	50	0	50	





*Massachusetts Department of Transportation-Highway Division*  
Statewide Traffic Data Collection

Framingham  
Route 30 at Burr Street  
Counted by Miovision  
S12-078 TMC # 3

File Name : S12-078TM3  
Site Code : 86814  
Start Date : 11/29/2012  
Page No : 1

Groups Printed- Pedal Bike (Crosswalk)

Start Time	Burr Street From North		Cochituate Road From East		Burr Street From South		Cochituate Road From West		Int. Total
	Peds	App. Total	Peds	App. Total	Peds	App. Total	Peds	App. Total	
05:00 PM	0	0	0	0	0	0	1	1	1
Total	0	0	0	0	0	0	1	1	1
Grand Total	0	0	0	0	0	0	1	1	1
Apprch %	0		0		0		100		
Total %	0		0		0		100	100	

# Massachusetts Department of Transportation-Highway Division

## Statewide Traffic Data Collection

Framingham  
 Rte 30 @ Shoppers World Dr/Whittier St.  
 Counted by Miovision  
 S12-078 TMC # 2

File Name : S12-078TM2  
 Site Code : 86813  
 Start Date : 11/29/2012  
 Page No : 1

### Groups Printed- Car - Truck - Motorcycle

Start Time	Whittier Street From North				Cochituate Road (Rte 30) From East				Shoppers World Drive From South				Cochituate Road (Rte 30) From West				Int. Total
	Right	Thru	Left	App. Total	Right	Thru	Left	App. Total	Right	Thru	Left	App. Total	Right	Thru	Left	App. Total	
07:00 AM	4	12	47	63	18	114	23	155	7	7	1	15	4	246	2	252	485
07:15 AM	4	29	62	95	23	162	34	219	5	6	6	17	8	247	5	260	591
07:30 AM	11	25	43	79	20	162	26	208	6	5	4	15	14	208	4	226	528
07:45 AM	8	33	54	95	24	207	39	270	5	19	7	31	18	222	19	259	655
Total	27	99	206	332	85	645	122	852	23	37	18	78	44	923	30	997	2259
08:00 AM	6	28	35	69	29	163	40	232	6	21	5	32	16	188	23	227	560
08:15 AM	11	31	32	74	31	205	43	279	2	11	4	17	7	177	18	202	572
08:30 AM	11	39	41	91	31	184	59	274	8	34	10	52	13	154	15	182	599
08:45 AM	7	37	25	69	52	148	47	247	7	30	9	46	16	167	15	198	560
Total	35	135	133	303	143	700	189	1032	23	96	28	147	52	686	71	809	2291
04:00 PM	18	79	65	162	49	192	80	321	28	62	20	110	19	138	9	166	759
04:15 PM	16	72	48	136	53	211	78	342	23	60	24	107	26	178	9	213	798
04:30 PM	18	93	65	176	47	190	76	313	22	59	21	102	31	177	5	213	804
04:45 PM	25	65	59	149	52	210	77	339	23	68	22	113	30	159	5	194	795
Total	77	309	237	623	201	803	311	1315	96	249	87	432	106	652	28	786	3156
05:00 PM	28	88	102	218	41	210	73	324	22	49	29	100	34	142	4	180	822
05:15 PM	26	91	67	184	50	213	78	341	33	55	24	112	29	143	18	190	827
05:30 PM	24	92	75	191	65	238	94	397	28	64	25	117	20	173	12	205	910
05:45 PM	17	77	48	142	45	275	76	396	32	62	25	119	26	134	24	184	841
Total	95	348	292	735	201	936	321	1458	115	230	103	448	109	592	58	759	3400
Grand Total	234	891	868	1993	630	3084	943	4657	257	612	236	1105	311	2853	187	3351	11106
Apprch %	11.7	44.7	43.6		13.5	66.2	20.2		23.3	55.4	21.4		9.3	85.1	5.6		
Total %	2.1	8	7.8	17.9	5.7	27.8	8.5	41.9	2.3	5.5	2.1	9.9	2.8	25.7	1.7	30.2	
Car	231	880	865	1976	625	2995	921	4541	254	607	233	1094	308	2782	180	3270	10881
% Car	98.7	98.8	99.7	99.1	99.2	97.1	97.7	97.5	98.8	99.2	98.7	99	99	97.5	96.3	97.6	98
Truck	3	11	3	17	5	89	22	116	3	5	3	11	3	70	7	80	224
% Truck	1.3	1.2	0.3	0.9	0.8	2.9	2.3	2.5	1.2	0.8	1.3	1	1	2.5	3.7	2.4	2
Motorcycle	0	0	0	0	0	0	0	0	0	0	0	0	0	1	0	1	1
% Motorcycle	0	0	0	0	0	0	0	0	0	0	0	0	0	0	0	0	0

# Massachusetts Department of Transportation-Highway Division

## Statewide Traffic Data Collection

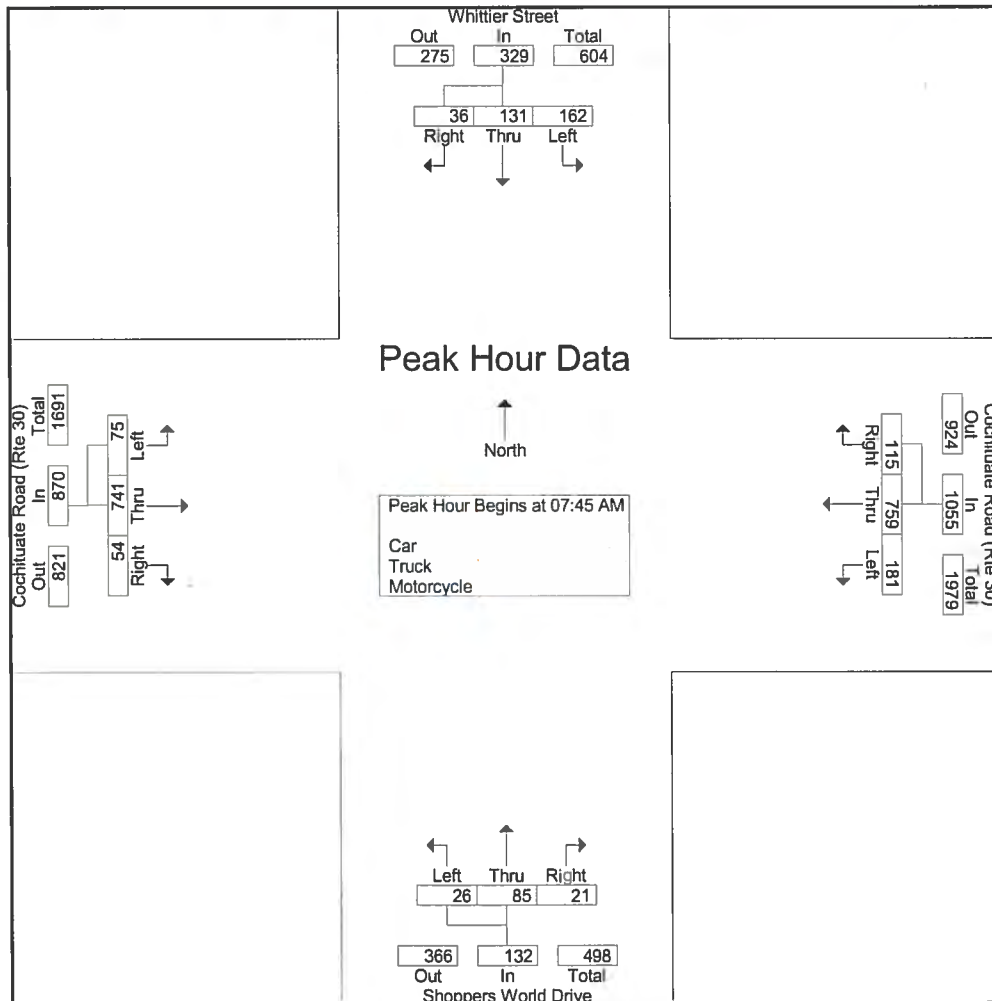
File Name : S12-078TM2

Site Code : 86813

Start Date : 11/29/2012

Page No : 2

Start Time	Whittier Street From North				Cochituate Road (Rte 30) From East				Shoppers World Drive From South				Cochituate Road (Rte 30) From West				Int. Total
	Right	Thru	Left	App. Total	Right	Thru	Left	App. Total	Right	Thru	Left	App. Total	Right	Thru	Left	App. Total	
Peak Hour Analysis From 07:00 AM to 11:45 AM - Peak 1 of 1																	
Peak Hour for Entire Intersection Begins at 07:45 AM																	
07:45 AM	8	33	54	95	24	207	39	270	5	19	7	31	18	222	19	259	655
08:00 AM	6	28	35	69	29	163	40	232	6	21	5	32	16	188	23	227	560
08:15 AM	11	31	32	74	31	205	43	279	2	11	4	17	7	177	18	202	572
08:30 AM	11	39	41	91	31	184	59	274	8	34	10	52	13	154	15	182	599
Total Volume	36	131	162	329	115	759	181	1055	21	85	26	132	54	741	75	870	2386
% App. Total	10.9	39.8	49.2		10.9	71.9	17.2		15.9	64.4	19.7		6.2	85.2	8.6		
PHF	.818	.840	.750	.866	.927	.917	.767	.945	.656	.625	.650	.635	.750	.834	.815	.840	.911

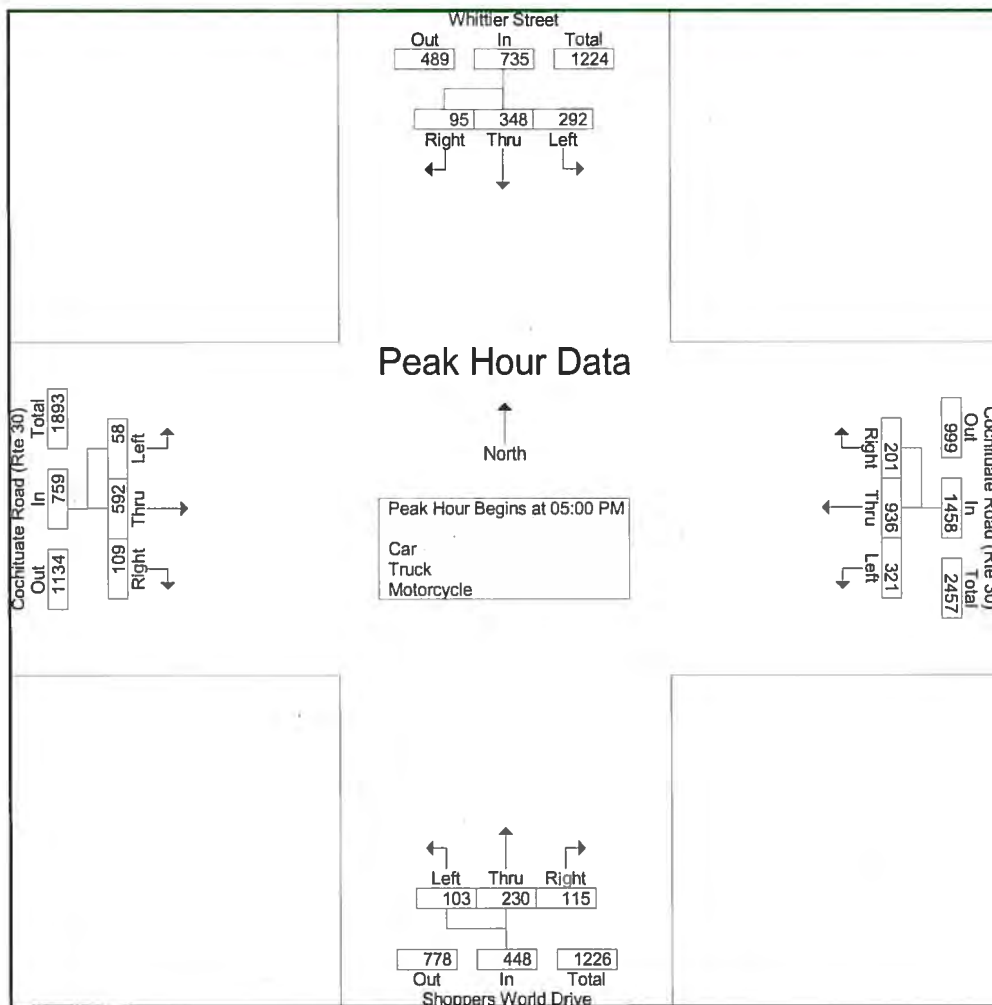


# Massachusetts Department of Transportation-Highway Division

## Statewide Traffic Data Collection

File Name : S12-078TM2  
 Site Code : 86813  
 Start Date : 11/29/2012  
 Page No : 3

Start Time	Whittier Street From North				Cochituate Road (Rte 30) From East				Shoppers World Drive From South				Cochituate Road (Rte 30) From West				Int. Total
	Right	Thru	Left	App. Total	Right	Thru	Left	App. Total	Right	Thru	Left	App. Total	Right	Thru	Left	App. Total	
Peak Hour Analysis From 12:00 PM to 05:45 PM - Peak 1 of 1																	
Peak Hour for Entire Intersection Begins at 05:00 PM																	
05:00 PM	28	88	102	218	41	210	73	324	22	49	29	100	34	142	4	180	822
05:15 PM	26	91	67	184	50	213	78	341	33	55	24	112	29	143	18	190	827
05:30 PM	24	92	75	191	65	238	94	397	28	64	25	117	20	173	12	205	910
05:45 PM	17	77	48	142	45	275	76	396	32	62	25	119	26	134	24	184	841
Total Volume	95	348	292	735	201	936	321	1458	115	230	103	448	109	592	58	759	3400
% App. Total	12.9	47.3	39.7		13.8	64.2	22		25.7	51.3	23		14.4	78	7.6		
PHF	.848	.946	.716	.843	.773	.851	.854	.918	.871	.898	.888	.941	.801	.855	.604	.926	.934





# Massachusetts Department of Transportation-Highway Division

Statewide Traffic Data Collection

Framingham  
 Rte 30 @ Shoppers World Dr/Whittier St.  
 Counted by Miovision  
 S12-078 TMC # 2

File Name : S12-078TM2  
 Site Code : 86813  
 Start Date : 11/29/2012  
 Page No : 1

Groups Printed- Car

Start Time	Whittier Street From North				Cochituate Road (Rte 30) From East				Shoppers World Drive From South				Cochituate Road (Rte 30) From West				Int. Total
	Right	Thru	Left	App. Total	Right	Thru	Left	App. Total	Right	Thru	Left	App. Total	Right	Thru	Left	App. Total	
07:00 AM	4	11	47	62	18	107	21	146	7	7	1	15	4	239	1	244	467
07:15 AM	4	29	62	95	23	154	33	210	4	6	5	15	8	242	4	254	574
07:30 AM	9	25	43	77	20	159	23	202	6	5	4	15	14	200	3	217	511
07:45 AM	8	33	54	95	24	200	39	263	5	17	7	29	18	212	19	249	636
Total	25	98	206	329	85	620	116	821	22	35	17	74	44	893	27	964	2188
08:00 AM	6	27	35	68	28	158	36	222	6	20	5	31	14	179	23	216	537
08:15 AM	11	29	32	72	30	193	41	264	2	11	4	17	7	172	17	196	549
08:30 AM	10	39	41	90	30	172	58	260	8	34	9	51	13	147	12	172	573
08:45 AM	7	36	25	68	52	143	47	242	7	30	9	46	16	163	15	194	550
Total	34	131	133	298	140	666	182	988	23	95	27	145	50	661	67	778	2209
04:00 PM	18	79	64	161	49	190	80	319	28	61	20	109	19	135	9	163	752
04:15 PM	16	72	48	136	52	201	74	327	23	60	24	107	26	175	9	210	780
04:30 PM	18	91	65	174	47	189	75	311	21	59	21	101	31	177	5	213	799
04:45 PM	25	64	59	148	51	206	75	332	23	68	21	112	30	156	5	191	783
Total	77	306	236	619	199	786	304	1289	95	248	86	429	106	643	28	777	3114
05:00 PM	28	87	101	216	41	208	73	322	22	49	29	100	34	141	4	179	817
05:15 PM	26	91	67	184	50	209	78	337	33	54	24	111	29	143	18	190	822
05:30 PM	24	90	74	188	65	237	92	394	28	64	25	117	19	170	12	201	900
05:45 PM	17	77	48	142	45	269	76	390	31	62	25	118	26	131	24	181	831
Total	95	345	290	730	201	923	319	1443	114	229	103	446	108	585	58	751	3370
Grand Total	231	880	865	1976	625	2995	921	4541	254	607	233	1094	308	2782	180	3270	10881
Apprch %	11.7	44.5	43.8		13.8	66	20.3		23.2	55.5	21.3		9.4	85.1	5.5		
Total %	2.1	8.1	7.9	18.2	5.7	27.5	8.5	41.7	2.3	5.6	2.1	10.1	2.8	25.6	1.7	30.1	

# Massachusetts Department of Transportation-Highway Division

Statewide Traffic Data Collection

Framingham  
 Rte 30 @ Shoppers World Dr/Whittier St.  
 Counted by Miovision  
 S12-078 TMC # 2

File Name : S12-078TM2  
 Site Code : 86813  
 Start Date : 11/29/2012  
 Page No : 1

Groups Printed- Truck

Start Time	Whittier Street From North				Cochituate Road (Rte 30) From East				Shoppers World Drive From South				Cochituate Road (Rte 30) From West				Int. Total
	Right	Thru	Left	App. Total	Right	Thru	Left	App. Total	Right	Thru	Left	App. Total	Right	Thru	Left	App. Total	
07:00 AM	0	1	0	1	0	7	2	9	0	0	0	0	0	7	1	8	18
07:15 AM	0	0	0	0	0	8	1	9	1	0	1	2	0	5	1	6	17
07:30 AM	2	0	0	2	0	3	3	6	0	0	0	0	0	8	1	9	17
07:45 AM	0	0	0	0	0	7	0	7	0	2	0	2	0	10	0	10	19
Total	2	1	0	3	0	25	6	31	1	2	1	4	0	30	3	33	71
08:00 AM	0	1	0	1	1	5	4	10	0	1	0	1	2	9	0	11	23
08:15 AM	0	2	0	2	1	12	2	15	0	0	0	0	0	5	1	6	23
08:30 AM	1	0	0	1	1	12	1	14	0	0	1	1	0	7	3	10	26
08:45 AM	0	1	0	1	0	5	0	5	0	0	0	0	0	4	0	4	10
Total	1	4	0	5	3	34	7	44	0	1	1	2	2	25	4	31	82
04:00 PM	0	0	1	1	0	2	0	2	0	1	0	1	0	3	0	3	7
04:15 PM	0	0	0	0	1	10	4	15	0	0	0	0	0	2	0	2	17
04:30 PM	0	2	0	2	0	1	1	2	1	0	0	1	0	0	0	0	5
04:45 PM	0	1	0	1	1	4	2	7	0	0	1	1	0	3	0	3	12
Total	0	3	1	4	2	17	7	26	1	1	1	3	0	8	0	8	41
05:00 PM	0	1	1	2	0	2	0	2	0	0	0	0	0	1	0	1	5
05:15 PM	0	0	0	0	0	4	0	4	0	1	0	1	0	0	0	0	5
05:30 PM	0	2	1	3	0	1	2	3	0	0	0	0	1	3	0	4	10
05:45 PM	0	0	0	0	0	6	0	6	1	0	0	1	0	3	0	3	10
Total	0	3	2	5	0	13	2	15	1	1	0	2	1	7	0	8	30
Grand Total	3	11	3	17	5	89	22	116	3	5	3	11	3	70	7	80	224
Apprch %	17.6	64.7	17.6		4.3	76.7	19		27.3	45.5	27.3		3.8	87.5	8.8		
Total %	1.3	4.9	1.3	7.6	2.2	39.7	9.8	51.8	1.3	2.2	1.3	4.9	1.3	31.2	3.1	35.7	

# Massachusetts Department of Transportation-Highway Division

Statewide Traffic Data Collection

Framingham  
 Rte 30 @ Shoppers World Dr/Whittier St.  
 Counted by Miovision  
 S12-078 TMC # 2

File Name : S12-078TM2  
 Site Code : 86813  
 Start Date : 11/29/2012  
 Page No : 1

Groups Printed- Motorcycle

Start Time	Whittier Street From North				Cochituate Road (Rte 30) From East				Shoppers World Drive From South				Cochituate Road (Rte 30) From West				Int. Total
	Right	Thru	Left	App. Total	Right	Thru	Left	App. Total	Right	Thru	Left	App. Total	Right	Thru	Left	App. Total	
04:15 PM	0	0	0	0	0	0	0	0	0	0	0	0	0	1	0	1	1
Total	0	0	0	0	0	0	0	0	0	0	0	0	0	1	0	1	1
Grand Total	0	0	0	0	0	0	0	0	0	0	0	0	0	1	0	1	1
Apprch %	0	0	0		0	0	0		0	0	0		0	100	0		
Total %	0	0	0		0	0	0		0	0	0		0	100	0	100	

# Massachusetts Department of Transportation-Highway Division

Statewide Traffic Data Collection

Framingham  
 Rte 30 @ Shoppers World Dr/Whittier St.  
 Counted by Miovision  
 S12-078 TMC # 2

File Name : S12-078TM2  
 Site Code : 86813  
 Start Date : 11/29/2012  
 Page No : 1

Groups Printed- People

Start Time	Whittier Street From North		Cochituate Road (Rte 30) From East		Shoppers World Drive From South		Cochituate Road (Rte 30) From West		Int. Total
	Peds	App. Total	Peds	App. Total	Peds	App. Total	Peds	App. Total	
08:15 AM	2	2	0	0	0	0	1	1	3
08:30 AM	1	1	0	0	0	0	0	0	1
08:45 AM	0	0	1	1	0	0	0	0	1
Total	3	3	1	1	0	0	1	1	5
04:00 PM	1	1	1	1	0	0	0	0	2
04:15 PM	0	0	0	0	0	0	1	1	1
Total	1	1	1	1	0	0	1	1	3
05:15 PM	0	0	0	0	0	0	1	1	1
Total	0	0	0	0	0	0	1	1	1
Grand Total	4	4	2	2	0	0	3	3	9
Apprch %	100		100		0		100		
Total %	44.4	44.4	22.2	22.2	0	0	33.3	33.3	





# Massachusetts Department of Transportation-Highway Division

Statewide Traffic Data Collection

Framingham  
 Route 30 @ Ring Road/Shoppers World Way  
 Counted by Miovision  
 S12-078 TMC #1

File Name : S12-078TM1  
 Site Code : 86812  
 Start Date : 11/29/2012  
 Page No : 1

Groups Printed- Car - Truck - Motorcycle

Start Time	Shoppers World Way From North				Cochituate Road (Rte 30) From East				Ring Road From South				Cochituate Road (Rte 30) From West				Int. Total
	Right	Thru	Left	App. Total	Right	Thru	Left	App. Total	Right	Thru	Left	App. Total	Right	Thru	Left	App. Total	
07:00 AM	13	1	6	20	5	111	4	120	4	9	6	19	9	232	16	257	416
07:15 AM	16	1	5	22	13	154	2	169	5	6	2	13	4	241	12	257	461
07:30 AM	14	5	7	26	4	164	7	175	11	4	9	24	4	205	15	224	449
07:45 AM	18	1	5	24	23	194	5	222	5	5	11	21	12	246	30	288	555
Total	61	8	23	92	45	623	18	686	25	24	28	77	29	924	73	1026	1881
08:00 AM	22	2	11	35	16	162	2	180	8	6	5	19	21	208	25	254	488
08:15 AM	29	4	13	46	19	185	9	213	4	7	6	17	19	176	35	230	506
08:30 AM	27	6	12	45	26	169	10	205	6	11	10	27	11	167	31	209	486
08:45 AM	30	6	16	52	14	133	9	156	10	17	8	35	17	173	33	223	466
Total	108	18	52	178	75	649	30	754	28	41	29	98	68	724	124	916	1946
04:00 PM	40	12	19	71	23	176	19	218	19	36	48	103	45	143	46	234	626
04:15 PM	57	12	25	94	35	208	10	253	12	28	40	80	25	169	35	229	656
04:30 PM	54	19	29	102	27	201	12	240	12	37	42	91	32	166	35	233	666
04:45 PM	55	13	21	89	32	214	9	255	12	28	45	85	42	158	44	244	673
Total	206	56	94	356	117	799	50	966	55	129	175	359	144	636	160	940	2621
05:00 PM	46	19	29	94	31	218	11	260	8	34	49	91	38	145	32	215	660
05:15 PM	43	9	29	81	37	197	16	250	17	25	38	80	31	141	38	210	621
05:30 PM	46	20	19	85	37	233	20	290	14	27	49	90	33	172	39	244	709
05:45 PM	51	14	14	79	33	271	15	319	4	25	43	72	29	163	41	233	703
Total	186	62	91	339	138	919	62	1119	43	111	179	333	131	621	150	902	2693
Grand Total	561	144	260	965	375	2990	160	3525	151	305	411	867	372	2905	507	3784	9141
Apprch %	58.1	14.9	26.9		10.6	84.8	4.5		17.4	35.2	47.4		9.8	76.8	13.4		
Total %	6.1	1.6	2.8	10.6	4.1	32.7	1.8	38.6	1.7	3.3	4.5	9.5	4.1	31.8	5.5	41.4	
Car	546	143	251	940	368	2907	153	3428	139	301	406	846	370	2842	502	3714	8928
% Car	97.3	99.3	96.5	97.4	98.1	97.2	95.6	97.2	92.1	98.7	98.8	97.6	99.5	97.8	99	98.2	97.7
Truck	14	1	8	23	7	83	7	97	12	4	5	21	2	61	5	68	209
% Truck	2.5	0.7	3.1	2.4	1.9	2.8	4.4	2.8	7.9	1.3	1.2	2.4	0.5	2.1	1	1.8	2.3
Motorcycle	1	0	1	2	0	0	0	0	0	0	0	0	0	2	0	2	4
% Motorcycle	0.2	0	0.4	0.2	0	0	0	0	0	0	0	0	0	0.1	0	0.1	0

# Massachusetts Department of Transportation-Highway Division

## Statewide Traffic Data Collection

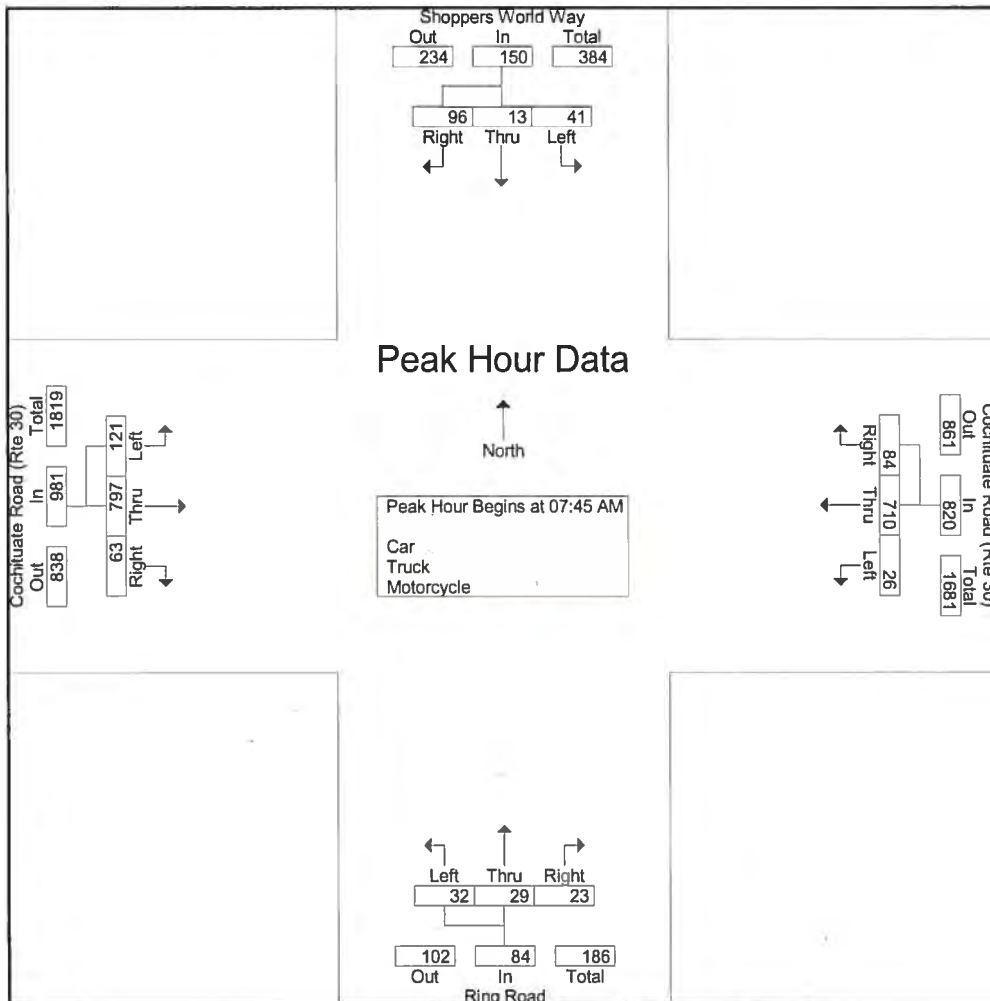
File Name : S12-078TM1

Site Code : 86812

Start Date : 11/29/2012

Page No : 2

Start Time	Shoppers World Way From North				Cochituate Road (Rte 30) From East				Ring Road From South				Cochituate Road (Rte 30) From West				Int. Total
	Right	Thru	Left	App. Total	Right	Thru	Left	App. Total	Right	Thru	Left	App. Total	Right	Thru	Left	App. Total	
Peak Hour Analysis From 07:00 AM to 11:45 AM - Peak 1 of 1																	
Peak Hour for Entire Intersection Begins at 07:45 AM																	
07:45 AM	18	1	5	24	23	194	5	222	5	5	11	21	12	246	30	288	555
08:00 AM	22	2	11	35	16	162	2	180	8	6	5	19	21	208	25	254	488
08:15 AM	29	4	13	46	19	185	9	213	4	7	6	17	19	176	35	230	506
08:30 AM	27	6	12	45	26	169	10	205	6	11	10	27	11	167	31	209	486
Total Volume	96	13	41	150	84	710	26	820	23	29	32	84	63	797	121	981	2035
% App. Total	64	8.7	27.3		10.2	86.6	3.2		27.4	34.5	38.1		6.4	81.2	12.3		
PHF	.828	.542	.788	.815	.808	.915	.650	.923	.719	.659	.727	.778	.750	.810	.864	.852	.917

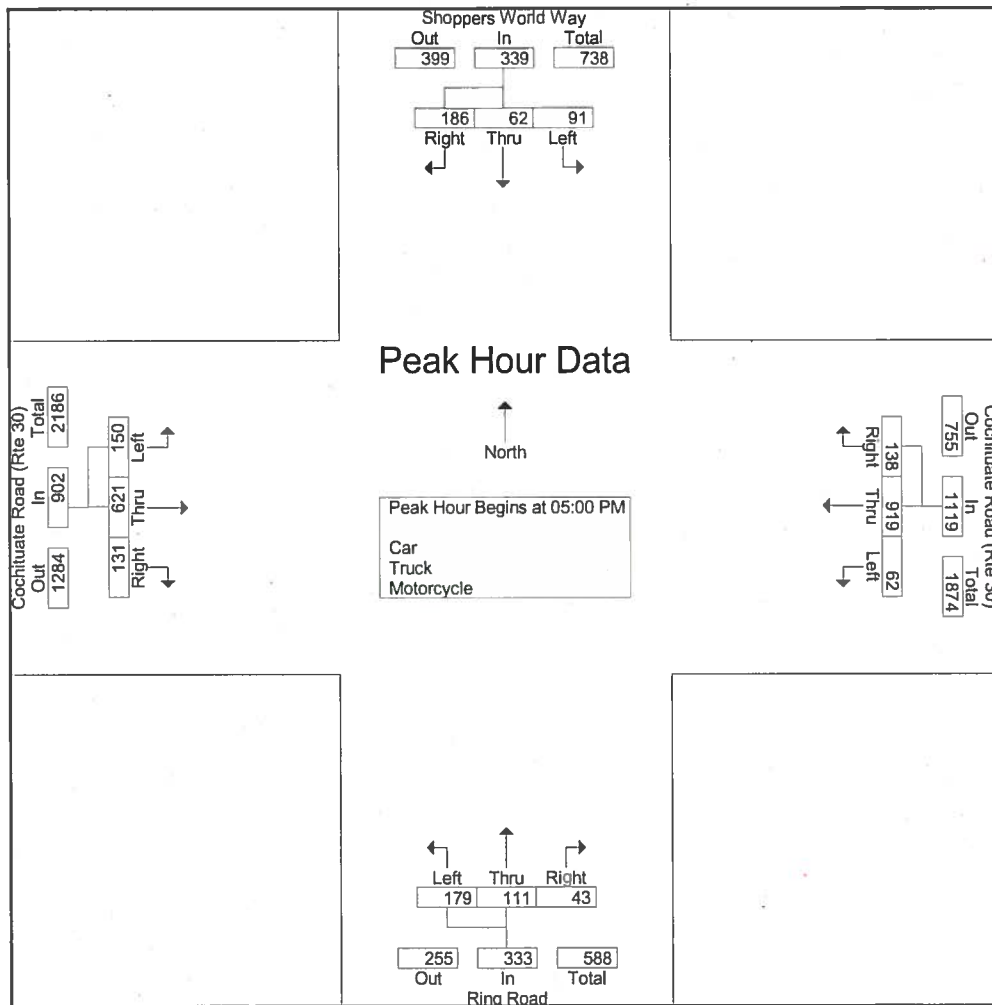


# Massachusetts Department of Transportation-Highway Division

## Statewide Traffic Data Collection

File Name : S12-078TM1  
 Site Code : 86812  
 Start Date : 11/29/2012  
 Page No : 3

Start Time	Shoppers World Way From North				Cochituate Road (Rte 30) From East				Ring Road From South				Cochituate Road (Rte 30) From West				Int. Total
	Right	Thru	Left	App. Total	Right	Thru	Left	App. Total	Right	Thru	Left	App. Total	Right	Thru	Left	App. Total	
Peak Hour Analysis From 12:00 PM to 05:45 PM - Peak 1 of 1																	
Peak Hour for Entire Intersection Begins at 05:00 PM																	
05:00 PM	46	19	29	94	31	218	11	260	8	34	49	91	38	145	32	215	660
05:15 PM	43	9	29	81	37	197	16	250	17	25	38	80	31	141	38	210	621
05:30 PM	46	20	19	85	37	233	20	290	14	27	49	90	33	172	39	244	709
05:45 PM	51	14	14	79	33	271	15	319	4	25	43	72	29	163	41	233	703
Total Volume	186	62	91	339	138	919	62	1119	43	111	179	333	131	621	150	902	2693
% App. Total	54.9	18.3	26.8		12.3	82.1	5.5		12.9	33.3	53.8		14.5	68.8	16.6		
PHF	.912	.775	.784	.902	.932	.848	.775	.877	.632	.816	.913	.915	.862	.903	.915	.924	.950





# Massachusetts Department of Transportation-Highway Division

## Statewide Traffic Data Collection

Framingham  
 Route 30 @ Ring Road/Shoppers World Way  
 Counted by Miovision  
 S12-078 TMC #1

File Name : S12-078TM1  
 Site Code : 86812  
 Start Date : 11/29/2012  
 Page No : 1

Groups Printed- Car

Start Time	Shoppers World Way From North				Cochituate Road (Rte 30) From East				Ring Road From South				Cochituate Road (Rte 30) From West				Int. Total
	Right	Thru	Left	App. Total	Right	Thru	Left	App. Total	Right	Thru	Left	App. Total	Right	Thru	Left	App. Total	
07:00 AM	12	1	5	18	4	107	3	114	3	9	5	17	9	225	16	250	399
07:15 AM	16	1	4	21	12	147	1	160	5	6	2	13	4	237	12	253	447
07:30 AM	12	5	7	24	4	159	6	169	8	3	8	19	4	199	15	218	430
07:45 AM	17	1	4	22	22	188	5	215	5	5	11	21	12	237	30	279	537
Total	57	8	20	85	42	601	15	658	21	23	26	70	29	898	73	1000	1813
08:00 AM	20	2	8	30	16	155	2	173	7	5	5	17	21	201	25	247	467
08:15 AM	27	4	13	44	17	176	8	201	2	7	5	14	19	172	35	226	485
08:30 AM	27	6	12	45	25	157	8	190	5	11	10	26	11	158	30	199	460
08:45 AM	26	5	15	46	14	129	9	152	9	16	8	33	17	170	32	219	450
Total	100	17	48	165	72	617	27	716	23	39	28	90	68	701	122	891	1862
04:00 PM	40	12	19	71	23	173	19	215	18	35	48	101	44	141	46	231	618
04:15 PM	57	12	24	93	35	198	10	243	12	28	40	80	25	167	35	227	643
04:30 PM	53	19	29	101	27	200	11	238	12	37	42	91	32	165	33	230	660
04:45 PM	54	13	21	88	32	209	9	250	12	28	45	85	42	155	43	240	663
Total	204	56	93	353	117	780	49	946	54	128	175	357	143	628	157	928	2584
05:00 PM	46	19	29	94	30	217	11	258	8	34	49	91	38	144	32	214	657
05:15 PM	43	9	29	81	37	194	16	247	17	25	37	79	30	141	38	209	616
05:30 PM	46	20	19	85	37	232	20	289	12	27	49	88	33	170	39	242	704
05:45 PM	50	14	13	77	33	266	15	314	4	25	42	71	29	160	41	230	692
Total	185	62	90	337	137	909	62	1108	41	111	177	329	130	615	150	895	2669
Grand Total	546	143	251	940	368	2907	153	3428	139	301	406	846	370	2842	502	3714	8928
Apprch %	58.1	15.2	26.7		10.7	84.8	4.5		16.4	35.6	48		10	76.5	13.5		
Total %	6.1	1.6	2.8	10.5	4.1	32.6	1.7	38.4	1.6	3.4	4.5	9.5	4.1	31.8	5.6	41.6	

# Massachusetts Department of Transportation-Highway Division

Statewide Traffic Data Collection

Framingham  
 Route 30 @ Ring Road/Shoppers World Way  
 Counted by Miovision  
 S12-078 TMC #1

File Name : S12-078TM1  
 Site Code : 86812  
 Start Date : 11/29/2012  
 Page No : 1

Groups Printed- Truck

Start Time	Shoppers World Way From North				Cochituate Road (Rte 30) From East				Ring Road From South				Cochituate Road (Rte 30) From West				Int. Total
	Right	Thru	Left	App. Total	Right	Thru	Left	App. Total	Right	Thru	Left	App. Total	Right	Thru	Left	App. Total	
07:00 AM	1	0	1	2	1	4	1	6	1	0	1	2	0	7	0	7	17
07:15 AM	0	0	1	1	1	7	1	9	0	0	0	0	0	4	0	4	14
07:30 AM	1	0	0	1	0	5	1	6	3	1	1	5	0	5	0	5	17
07:45 AM	1	0	1	2	1	6	0	7	0	0	0	0	0	9	0	9	18
Total	3	0	3	6	3	22	3	28	4	1	2	7	0	25	0	25	66
08:00 AM	2	0	3	5	0	7	0	7	1	1	0	2	0	7	0	7	21
08:15 AM	2	0	0	2	2	9	1	12	2	0	1	3	0	4	0	4	21
08:30 AM	0	0	0	0	1	12	2	15	1	0	0	1	0	9	1	10	26
08:45 AM	4	1	1	6	0	4	0	4	1	1	0	2	0	3	1	4	16
Total	8	1	4	13	3	32	3	38	5	2	1	8	0	23	2	25	84
04:00 PM	0	0	0	0	0	3	0	3	1	1	0	2	1	2	0	3	8
04:15 PM	0	0	0	0	0	10	0	10	0	0	0	0	0	2	0	2	12
04:30 PM	1	0	0	1	0	1	1	2	0	0	0	0	0	1	2	3	6
04:45 PM	1	0	0	1	0	5	0	5	0	0	0	0	0	3	1	4	10
Total	2	0	0	2	0	19	1	20	1	1	0	2	1	8	3	12	36
05:00 PM	0	0	0	0	1	1	0	2	0	0	0	0	0	1	0	1	3
05:15 PM	0	0	0	0	0	3	0	3	0	0	1	1	1	0	0	1	5
05:30 PM	0	0	0	0	0	1	0	1	2	0	0	2	0	2	0	2	5
05:45 PM	1	0	1	2	0	5	0	5	0	0	1	1	0	2	0	2	10
Total	1	0	1	2	1	10	0	11	2	0	2	4	1	5	0	6	23
Grand Total	14	1	8	23	7	83	7	97	12	4	5	21	2	61	5	68	209
Apprch %	60.9	4.3	34.8		7.2	85.6	7.2		57.1	19	23.8		2.9	89.7	7.4		
Total %	6.7	0.5	3.8	11	3.3	39.7	3.3	46.4	5.7	1.9	2.4	10	1	29.2	2.4	32.5	

# Massachusetts Department of Transportation-Highway Division

Statewide Traffic Data Collection

Framingham  
 Route 30 @ Ring Road/Shoppers World Way  
 Counted by Miovision  
 S12-078 TMC #1

File Name : S12-078TM1  
 Site Code : 86812  
 Start Date : 11/29/2012  
 Page No : 1

Groups Printed- Motorcycle

Start Time	Shoppers World Way From North				Cochituate Road (Rte 30) From East				Ring Road From South				Cochituate Road (Rte 30) From West				Int. Total
	Right	Thru	Left	App. Total	Right	Thru	Left	App. Total	Right	Thru	Left	App. Total	Right	Thru	Left	App. Total	
07:30 AM	1	0	0	1	0	0	0	0	0	0	0	0	0	1	0	1	2
Total	1	0	0	1	0	0	0	0	0	0	0	0	0	1	0	1	2
04:15 PM	0	0	1	1	0	0	0	0	0	0	0	0	0	0	0	0	1
Total	0	0	1	1	0	0	0	0	0	0	0	0	0	0	0	0	1
05:45 PM	0	0	0	0	0	0	0	0	0	0	0	0	0	1	0	1	1
Total	0	0	0	0	0	0	0	0	0	0	0	0	0	1	0	1	1
Grand Total	1	0	1	2	0	0	0	0	0	0	0	0	0	2	0	2	4
Apprch %	50	0	50		0	0	0		0	0	0		0	100	0		
Total %	25	0	25	50	0	0	0	0	0	0	0	0	0	50	0	50	

# Massachusetts Department of Transportation-Highway Division

Statewide Traffic Data Collection

Framingham  
 Route 30 @ Ring Road/Shoppers World Way  
 Counted by Miovision  
 S12-078 TMC #1

File Name : S12-078TM1  
 Site Code : 86812  
 Start Date : 11/29/2012  
 Page No : 1

Groups Printed- People

Start Time	Shoppers World Way From North		Cochituate Road (Rte 30) From East		Ring Road From South		Cochituate Road (Rte 30) From West		Int. Total
	Peds	App. Total	Peds	App. Total	Peds	App. Total	Peds	App. Total	
07:00 AM	0	0	1	1	0	0	0	0	1
07:15 AM	0	0	1	1	0	0	0	0	1
07:30 AM	0	0	1	1	0	0	0	0	1
07:45 AM	1	1	0	0	0	0	0	0	1
Total	1	1	3	3	0	0	0	0	4
08:15 AM	1	1	0	0	0	0	0	0	1
08:30 AM	0	0	0	0	1	1	0	0	1
Total	1	1	0	0	1	1	0	0	2
04:00 PM	1	1	1	1	0	0	0	0	2
04:15 PM	0	0	0	0	0	0	1	1	1
04:30 PM	0	0	1	1	2	2	0	0	3
04:45 PM	0	0	2	2	0	0	0	0	2
Total	1	1	4	4	2	2	1	1	8
05:00 PM	0	0	1	1	0	0	0	0	1
05:15 PM	1	1	1	1	0	0	0	0	2
05:30 PM	0	0	1	1	0	0	0	0	1
05:45 PM	0	0	1	1	0	0	0	0	1
Total	1	1	4	4	0	0	0	0	5
Grand Total	4	4	11	11	3	3	1	1	19
Apprch %	100		100		100		100		
Total %	21.1	21.1	57.9	57.9	15.8	15.8	5.3	5.3	



# Massachusetts Department of Transportation-Highway Division

Statewide Traffic Data Collection

Framingham  
 Route 30 @ Ring Road/Shoppers World Way  
 Counted by Miovision  
 S12-078 TMC #1

File Name : S12-078TM1  
 Site Code : 86812  
 Start Date : 11/29/2012  
 Page No : 1

Groups Printed- Pedal Bike (Crosswalk)

Start Time	Shoppers World Way From North		Cochituate Road (Rte 30) From East		Ring Road From South		Cochituate Road (Rte 30) From West		Int. Total
	Peds	App. Total	Peds	App. Total	Peds	App. Total	Peds	App. Total	
05:30 PM	0	0	1	1	0	0	0	0	1
<b>Total</b>	0	0	1	1	0	0	0	0	1
<b>Grand Total</b>	0	0	1	1	0	0	0	0	1
Apprch %	0		100		0		0		
Total %	0		100	100	0		0		

Mass Highway Department  
 WEEKLY SUMMARY FOR LANE 1  
 Starting: 11/26/2012

Page: 1

STA. 1

Site Reference: 120780000658  
 Site ID: 000000000100  
 Location: ON-RAMP FROM RTE. 30 WB TO I-90  
 Direction: NORTH

File: 100.prn  
 City: FRAMINGHAM  
 County: VOL

TIME	MON 26	TUE 27	WED 28	THU 29	FRI 30	WKDAY AVG	SAT	SUN	WEEK AVG	TOTAL
01:00		51	40	52	54	49			49	197
02:00		29	20	25	27	25			25	101
03:00		26	34	28	28	29			29	116
04:00		49	43	50	36	44			44	178
05:00		107	129	111	114	115			115	461
06:00		402	368	343	329	360			360	1442
07:00		922	891	958	833	901			901	3604
08:00		985	1000	1049	1053	1021			1021	4087
09:00		629	649	648	705	657			657	2631
10:00		578	608	618		601			601	1804
11:00	613	574	622	593		600			600	2402
12:00	618	622	595	721		639			639	2556
13:00	621	621	659	774		668			668	2675
14:00	728	714	784	821		761			761	3047
15:00	906	925	933	1019		945			945	3783
16:00	1125	1103	1139	1151		1129			1129	4518
17:00	1348	1377	1436	1484		1411			1411	5645
18:00	1462	1418	1427	1410		1429			1429	5717
19:00	837	882	835	873		856			856	3427
20:00	484	463	547	612		526			526	2106
21:00	368	401	433	492		423			423	1694
22:00	349	313	393	417		368			368	1472
23:00	145	154	160	203		165			165	662
24:00	89	92	95	97		93			93	373
TOTALS	9693	13437	13840	14549	3179	13815	0	0	13815	54698
% AVG WKDY	70.1	97.2	100.1	105.3	23					
% AVG WEEK	70.1	97.2	100.1	105.3	23					
AM Times	12:00	08:00	08:00	08:00	08:00	08:00			08:00	
AM Peaks	618	985	1000	1049	1053	1021			1021	
PM Times	18:00	18:00	17:00	17:00		18:00			18:00	
PM Peaks	1462	1418	1436	1484		1429			1429	

Mass Highway Department  
 WEEKLY SUMMARY FOR LANE 1  
 Starting: 11/26/2012

Page: 1

STA. 2

Site Reference: 120780000738  
 Site ID: 000000000200  
 Location: OFF-RAMP FROM I-90 TO RTE. 30 EB  
 Direction: NORTH

File: 200.prn  
 City: FRAMINGHAM  
 County: VOL

TIME	MON 26	TUE 27	WED 28	THU 29	FRI 30	WKDAY AVG	SAT	SUN	WEEK AVG	TOTAL
01:00		66	51	64	69	62			62	250
02:00		22	29	27	37	28			28	115
03:00		10	19	17	36	20			20	82
04:00		14	24	22	15	18			18	75
05:00		47	45	40	51	45			45	183
06:00		153	155	138	161	151			151	607
07:00		544	539	591	618	573			573	2292
08:00		1069	981	950	1070	1017			1017	4070
09:00		1686	1619	1720	1615	1660			1660	6640
10:00		1048	1129	1127		1101			1101	3304
11:00	643	652	641	742		669			669	2678
12:00	591	601	646	686		631			631	2524
13:00	653	526	671	688		634			634	2538
14:00	604	662	574	608		612			612	2448
15:00	647	546	630	649		618			618	2472
16:00	734	712	733	705		721			721	2884
17:00	746	714	782	768		752			752	3010
18:00	1002	830	957	964		938			938	3753
19:00	833	783	895	953		866			866	3464
20:00	484	505	516	618		530			530	2123
21:00	305	338	325	339		326			326	1307
22:00	209	251	242	265		241			241	967
23:00	149	180	217	206		188			188	752
24:00	90	100	109	145		111			111	444
TOTALS	7690	12059	12529	13032	3672	12512	0	0	12512	48982
% AVG WKDY	61.4	96.3	100.1	104.1	29.3					
% AVG WEEK	61.4	96.3	100.1	104.1	29.3					
AM Times	11:00	09:00	09:00	09:00	09:00	09:00			09:00	
AM Peaks	643	1686	1619	1720	1615	1660			1660	
PM Times	18:00	18:00	18:00	18:00		18:00			18:00	
PM Peaks	1002	830	957	964		938			938	

Mass Highway Department  
 WEEKLY SUMMARY FOR LANE 1  
 Starting: 11/26/2012

Page: 1

STA. 3

Site Reference: 120780000527  
 Site ID: 000000000300  
 Location: OFF-RAMP FROM I-90 TO RTE. 30 WB  
 Direction: NORTH

File: 300.prn  
 City: FRAMINGHAM  
 County: VOL

TIME	MON 26	TUE 27	WED 28	THU 29	FRI 30	WKDAY AVG	SAT	SUN	WEEK AVG	TOTAL
01:00		101	78	100	93	93			93	372
02:00		38	45	39	59	45			45	181
03:00		33	27	36	48	36			36	144
04:00		29	22	28	33	28			28	112
05:00		46	52	52	63	53			53	213
06:00		156	154	117	144	142			142	571
07:00		479	438	450	453	455			455	1820
08:00		1014	975	994	972	988			988	3955
09:00		1633	1596	1649	1598	1619			1619	6476
10:00		1107	1209	1206		1174			1174	3522
11:00	724	723	791	789		756			756	3027
12:00	686	688	805	803		745			745	2982
13:00	736	672	767	792		741			741	2967
14:00	660	682	698	746		696			696	2786
15:00	732	722	801	846		775			775	3101
16:00	911	883	936	873		900			900	3603
17:00	964	853	993	908		929			929	3718
18:00	1208	1024	1165	1115		1128			1128	4512
19:00	996	1048	986	1143		1043			1043	4173
20:00	658	674	707	740		694			694	2779
21:00	421	427	469	466		445			445	1783
22:00	290	337	333	408		342			342	1368
23:00	216	245	311	294		266			266	1066
24:00	128	141	166	168		150			150	603
TOTALS	9330	13755	14524	14762	3463	14243	0	0	14243	55834
% AVG WKDY	65.5	96.5	101.9	103.6	24.3					
% AVG WEEK	65.5	96.5	101.9	103.6	24.3					
AM Times	11:00	09:00	09:00	09:00	09:00	09:00			09:00	
AM Peaks	724	1633	1596	1649	1598	1619			1619	
PM Times	18:00	19:00	18:00	19:00		18:00			18:00	
PM Peaks	1208	1048	1165	1143		1128			1128	



Mass Highway Department  
 WEEKLY SUMMARY FOR LANE 1  
 Starting: 11/26/2012

Page: 1

STA. 4

Site Reference: 120780000685  
 Site ID: 000000000400  
 Location: ON-RAMP FROM RTE. 30 EB TO I-90  
 Direction: NORTH

File: 400.prn  
 City: FRAMINGHAM  
 County: VOL

TIME	MON 26	TUE 27	WED 28	THU 29	FRI 30	WKDAY AVG	SAT	SUN	WEEK AVG	TOTAL
01:00		63	53	48	63	56			56	227
02:00		15	26	24	28	23			23	93
03:00		19	16	14	22	17			17	71
04:00		25	33	41	36	33			33	135
05:00		88	65	68	70	72			72	291
06:00		240	231	248	240	239			239	959
07:00		794	796	806	685	770			770	3081
08:00		929	940	991	858	929			929	3718
09:00		541	524	526	580	542			542	2171
10:00		440	499	500		479			479	1439
11:00	427	498	477	529		482			482	1931
12:00	476	497	522	576		517			517	2071
13:00	571	571	682	641		616			616	2465
14:00	575	569	630	736		627			627	2510
15:00	731	715	748	823		754			754	3017
16:00	822	873	895	919		877			877	3509
17:00	1104	1066	1110	1115		1098			1098	4395
18:00	1318	1184	1239	1267		1252			1252	5008
19:00	762	797	791	833		795			795	3183
20:00	485	514	524	612		533			533	2135
21:00	376	376	418	481		412			412	1651
22:00	325	326	392	430		368			368	1473
23:00	165	184	191	235		193			193	775
24:00	81	108	107	115		102			102	411
TOTALS	8218	11432	11909	12578	2582	11786	0	0	11786	46719
% AVG WKDY	69.7	96.9	101	106.7	21.9					
% AVG WEEK	69.7	96.9	101	106.7	21.9					
AM Times	12:00	08:00	08:00	08:00	08:00	08:00			08:00	
AM Peaks	476	929	940	991	858	929			929	
PM Times	18:00	18:00	18:00	18:00		18:00			18:00	
PM Peaks	1318	1184	1239	1267		1252			1252	

Mass Highway Department  
 WEEKLY SUMMARY FOR LANE  
 Starting: 11/26/2012

STA .5  
 TOTAL

Site Reference: 120780000482  
 Site ID: 000000000503  
 Location: RTE. 30, BTWN RAMP 1 & 2 UNDER OVERPASS  
 Direction: ROAD TOTAL

File: 5-E&W.prn  
 City: FRAMINGHAM  
 County: VOL E&W

TIME	MON 26	TUE 27	WED 28	THU 29	FRI 30	WKDAY AVG	SAT	SUN	WEEK AVG	TOTAL
01:00		129	116	139	158	135			135	542
02:00		67	73	82	85	76			76	307
03:00		37	40	40	83	50			50	200
04:00		44	57	61	45	51			51	207
05:00		105	117	103	113	109			109	438
06:00		268	283	261	269	270			270	1081
07:00		878	890	912	961	910			910	3641
08:00		1687	1575	1569	1664	1623			1623	6495
09:00		2537	2489	2578	2395	2499			2499	9999
10:00		1950	2013	1927		1963			1963	5890
11:00	1554	1604	1537	1546		1560			1560	6241
12:00	1661	1595	1633	1711		1650			1650	6600
13:00	1962	1799	2140	2018		1979			1979	7919
14:00	1775	1779	1865	1858		1819			1819	7277
15:00	1735	1562	1735	1763		1698			1698	6795
16:00	1791	1683	1766	1725		1741			1741	6965
17:00	1737	1698	1849	1804		1772			1772	7088
18:00	2068	1801	1901	2017		1946			1946	7787
19:00	1656	1623	1854	1895		1757			1757	7028
20:00	1158	1154	1235	1325		1218			1218	4872
21:00	841	812	912	870		858			858	3435
22:00	587	637	653	708		646			646	2585
23:00	328	376	449	455		402			402	1608
24:00	190	221	229	263		225			225	903
TOTALS	19043	26046	27411	27630	5773	26957	0	0	26957	105903
% AVG WKDY	70.6	96.6	101.6	102.4	21.4					
% AVG WEEK	70.6	96.6	101.6	102.4	21.4					
AM Times	12:00	09:00	09:00	09:00	09:00	09:00			09:00	
AM Peaks	1661	2537	2489	2578	2395	2499			2499	
PM Times	18:00	18:00	13:00	13:00		13:00			13:00	
PM Peaks	2068	1801	2140	2018		1979			1979	

Mass Highway Department  
 WEEKLY SUMMARY FOR LANE 1  
 Starting: 11/26/2012

Page: 1

STA. 5 EB

Site Reference: 120780000482  
 Site ID: 000000000503  
 Location: RTE. 30, BTWN RAMP 1 & 2 UNDER OVERPASS  
 Direction: WEST

File: 5-E&W.prn  
 City: FRAMINGHAM  
 County: VOL E&W

TIME	MON 26	TUE 27	WED 28	THU 29	FRI 30	WKDAY AVG	SAT	SUN	WEEK AVG	TOTAL
01:00		98	86	102	124	102			102	410
02:00		42	54	56	56	52			52	208
03:00		21	30	30	61	35			35	142
04:00		32	42	41	29	36			36	144
05:00		77	85	72	84	79			79	318
06:00		222	232	209	226	222			222	889
07:00		752	769	798	832	787			787	3151
08:00		1420	1332	1309	1404	1366			1366	5465
09:00		2120	2053	2145	1977	2073			2073	8295
10:00		1458	1516	1472		1482			1482	4446
11:00	1061	1088	1025	1076		1062			1062	4250
12:00	1080	1039	1105	1141		1091			1091	4365
13:00	1290	1169	1366	1334		1289			1289	5159
14:00	1175	1279	1229	1249		1233			1233	4932
15:00	1211	1056	1199	1236		1175			1175	4702
16:00	1257	1189	1252	1225		1230			1230	4923
17:00	1279	1190	1347	1278		1273			1273	5094
18:00	1518	1345	1430	1489		1445			1445	5782
19:00	1229	1151	1352	1418		1287			1287	5150
20:00	848	842	854	948		873			873	3492
21:00	618	611	648	632		627			627	2509
22:00	401	466	485	505		464			464	1857
23:00	237	281	337	339		298			298	1194
24:00	137	165	163	203		167			167	668
TOTALS	13341	19113	19991	20307	4793	19748	0	0	19748	77545
% AVG WKDY	67.5	96.7	101.2	102.8	24.2					
% AVG WEEK	67.5	96.7	101.2	102.8	24.2					
AM Times	12:00	09:00	09:00	09:00	09:00	09:00			09:00	
AM Peaks	1080	2120	2053	2145	1977	2073			2073	
PM Times	18:00	18:00	18:00	18:00		18:00			18:00	
PM Peaks	1518	1345	1430	1489		1445			1445	

Mass Highway Department  
 WEEKLY SUMMARY FOR LANE 2  
 Starting: 11/26/2012

STA. 5WB

Site Reference: 120780000482  
 Site ID: 000000000503  
 Location: RTE. 30, BTWN RAMP 1 & 2 UNDER OVERPASS  
 Direction:

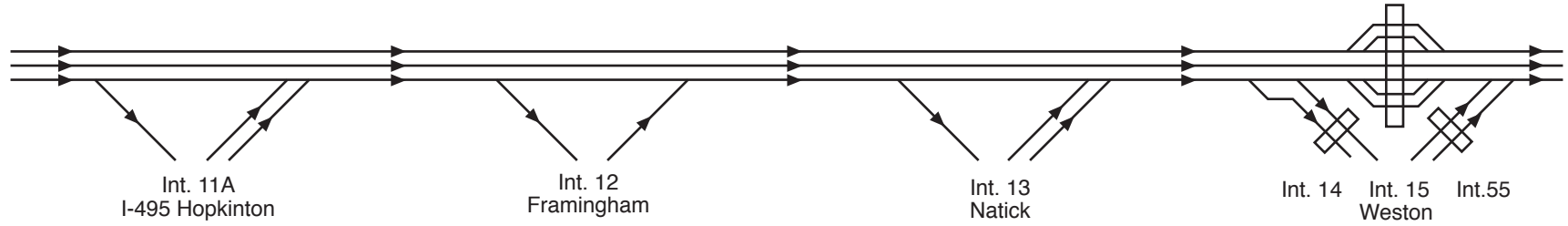
File: 5-E&W.prn  
 City: FRAMINGHAM  
 County: VOL E&W

TIME	MON 26	TUE 27	WED 28	THU 29	FRI 30	WKDAY AVG	SAT	SUN	WEEK AVG	TOTAL
01:00		31	30	37	34	33			33	132
02:00		25	19	26	29	24			24	99
03:00		16	10	10	22	14			14	58
04:00		12	15	20	16	15			15	63
05:00		28	32	31	29	30			30	120
06:00		46	51	52	43	48			48	192
07:00		126	121	114	129	122			122	490
08:00		267	243	260	260	257			257	1030
09:00		417	436	433	418	426			426	1704
10:00		492	497	455		481			481	1444
11:00	493	516	512	470		497			497	1991
12:00	581	556	528	570		558			558	2235
13:00	672	630	774	684		690			690	2760
14:00	600	500	636	609		586			586	2345
15:00	524	506	536	527		523			523	2093
16:00	534	494	514	500		510			510	2042
17:00	458	508	502	526		498			498	1994
18:00	550	456	471	528		501			501	2005
19:00	427	472	502	477		469			469	1878
20:00	310	312	381	377		345			345	1380
21:00	223	201	264	238		231			231	926
22:00	186	171	168	203		182			182	728
23:00	91	95	112	116		103			103	414
24:00	53	56	66	60		58			58	235
<hr/>										
TOTALS	5702	6933	7420	7323	980	7201	0	0	7201	28358
<hr/>										
% AVG WKDY	79.1	96.2	103	101.6	13.6					
% AVG WEEK	79.1	96.2	103	101.6	13.6					
<hr/>										
AM Times	12:00	12:00	12:00	12:00	09:00	12:00			12:00	
AM Peaks	581	556	528	570	418	558			558	
<hr/>										
PM Times	13:00	13:00	13:00	13:00		13:00			13:00	
PM Peaks	672	630	774	684		690			690	

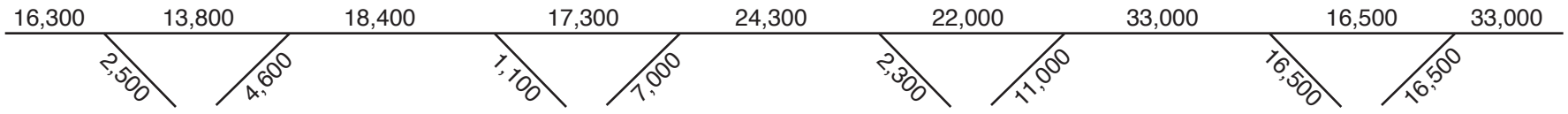


## I-90/Mass Turnpike Eastbound: I-495, Hopkinton, to I-95/Route 128, Weston AWDT Traffic Flow Diagrams: 1977, 1987, 1997, and 2010

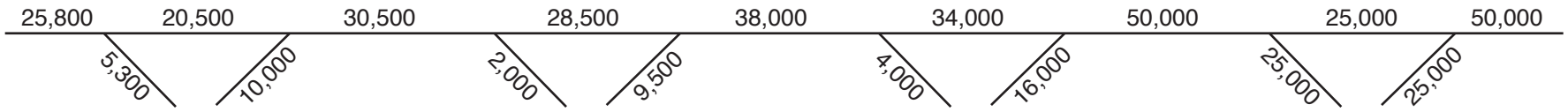
### Route/Lane Schematic



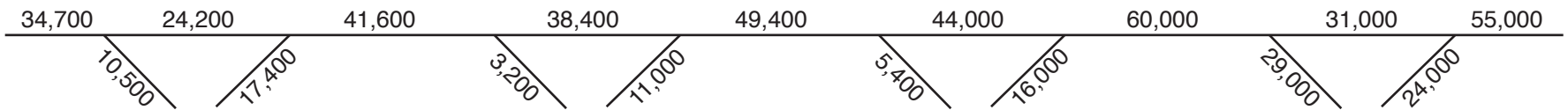
### 1977 AWDT



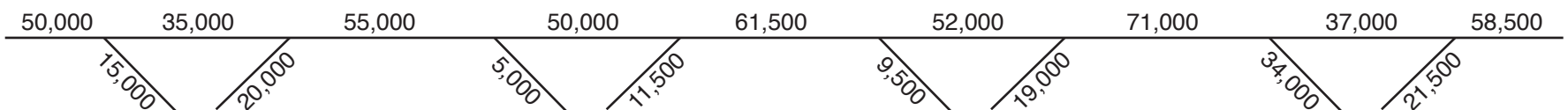
### 1987 AWDT



### 1997 AWDT

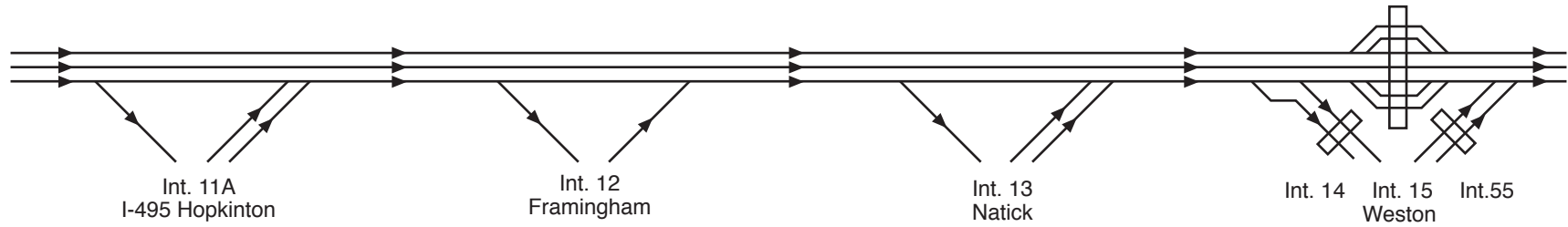


### 2010 AWDT

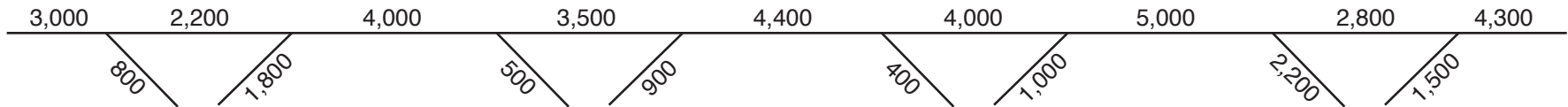


## I-90/Mass Turnpike Eastbound: I-495, Hopkinton, to I-95/Route 128, Weston AM Peak Period Traffic Flow Diagrams: 2010

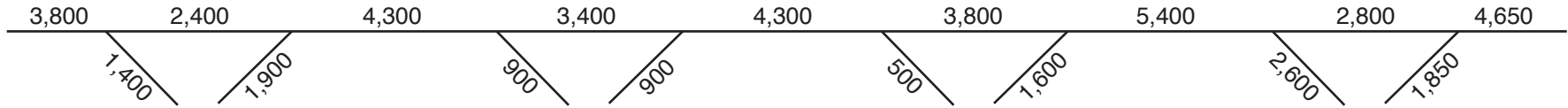
### Route/Lane Schematic



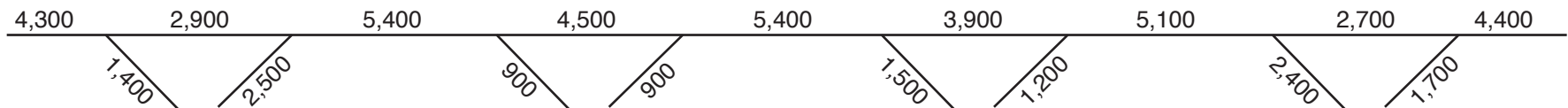
### 6-7 AM



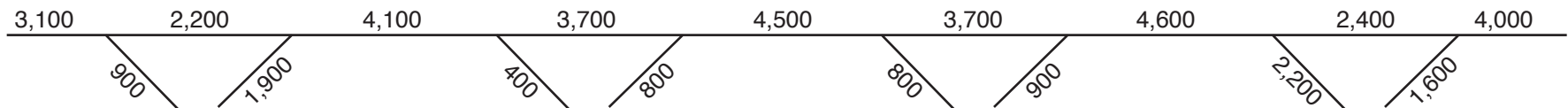
### 7-8 AM



### 8-9 AM

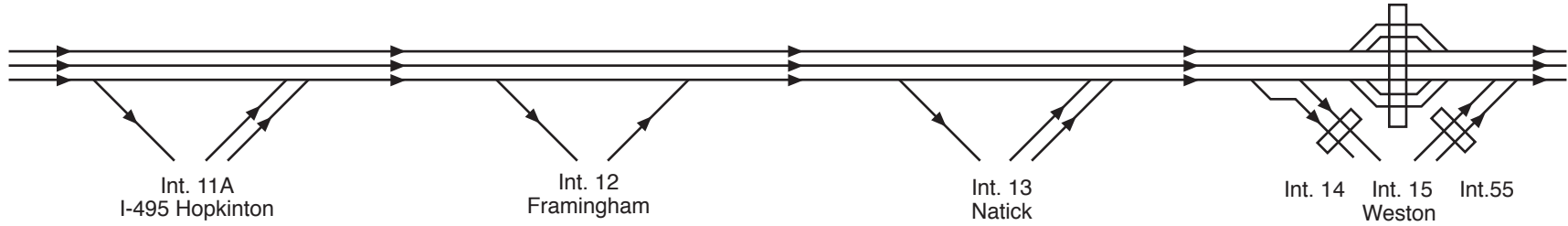


### 9-10 AM

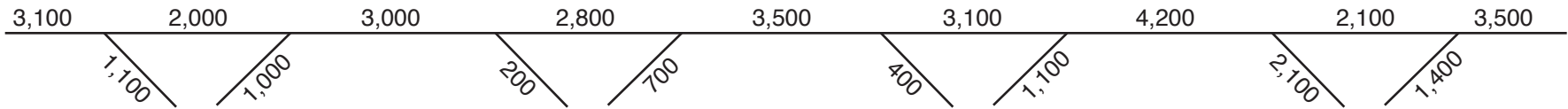


## I-90/Mass Turnpike Eastbound: I-495, Hopkinton, to I-95/Route 128, Weston PM Peak Period Traffic Flow Diagrams: 2010

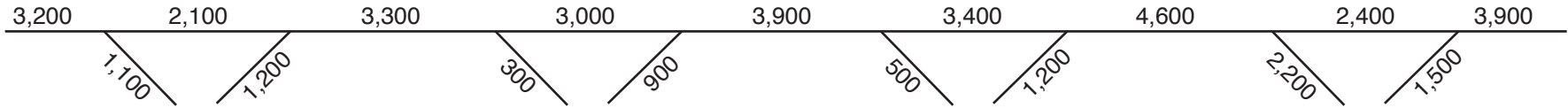
### Route/Lane Schematic



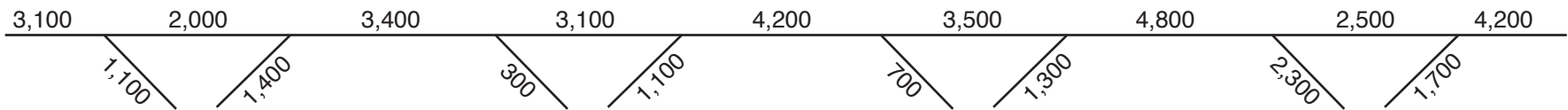
### 3-4 PM



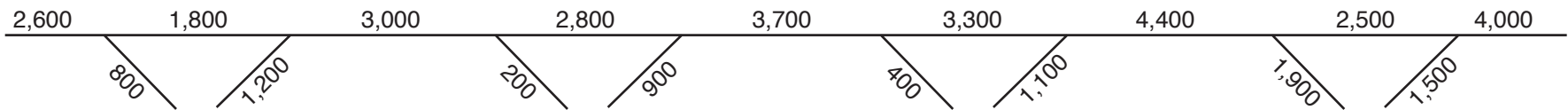
### 4-5 PM



### 5-6 PM

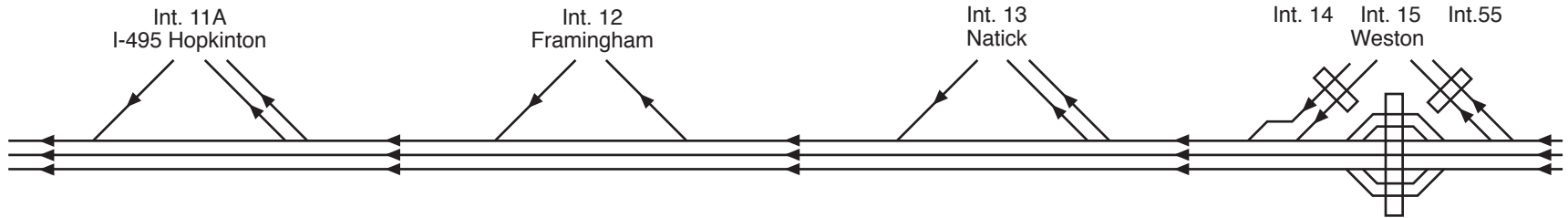


### 6-7 PM



# I-90/Mass Turnpike Westbound: I-95/Route 128, Weston, to I-495, Hopkinton AWDT Traffic Flow Diagrams: 1977, 1987, 1997, and 2010

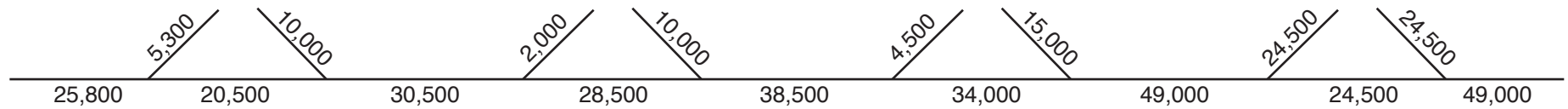
## Route/Lane Schematic



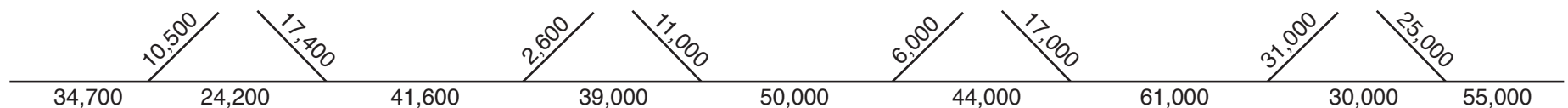
## 1977 AWDT



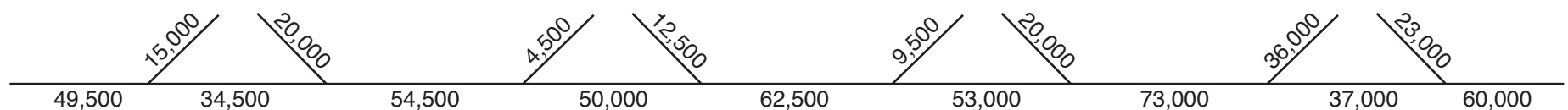
## 1987 AWDT



## 1997 AWDT



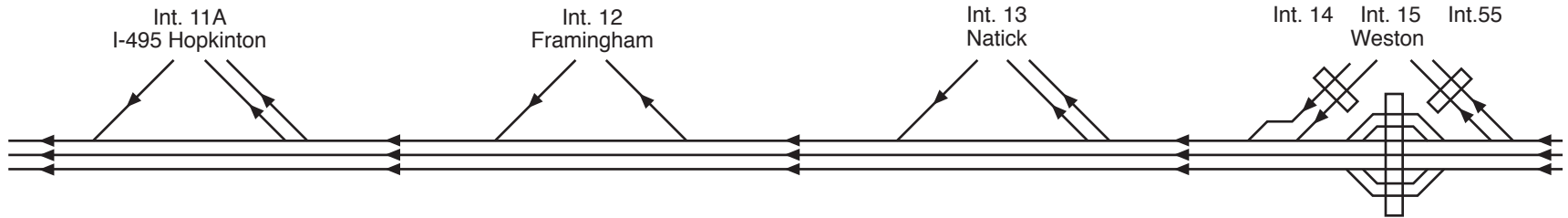
## 2010 AWDT



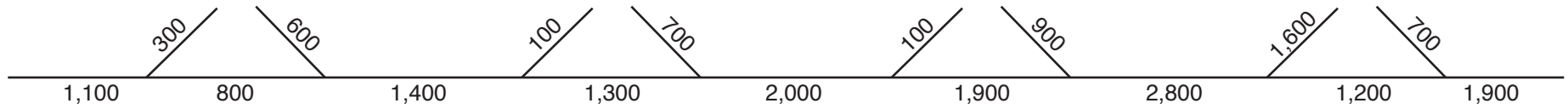


# I-90/Mass Turnpike Westbound: I-95/Route 128, Weston, to I-495, Hopkinton AM Peak Period Traffic Flow Diagrams: 2010

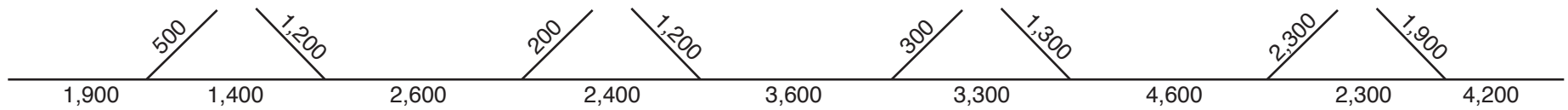
## Route/Lane Schematic



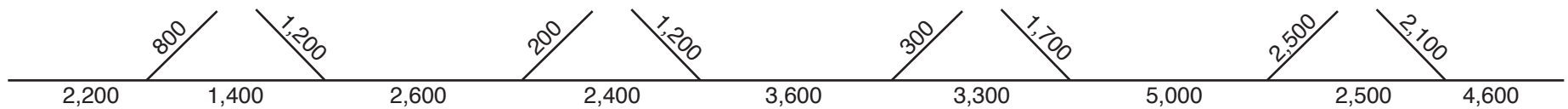
### 6-7 AM



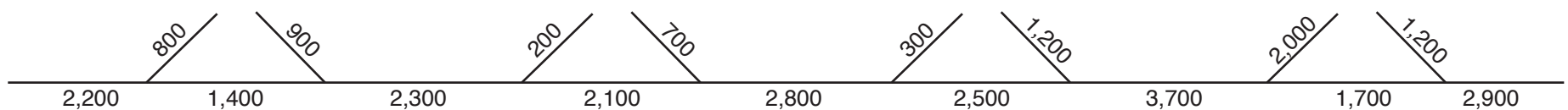
### 7-8 AM



### 8-9 AM

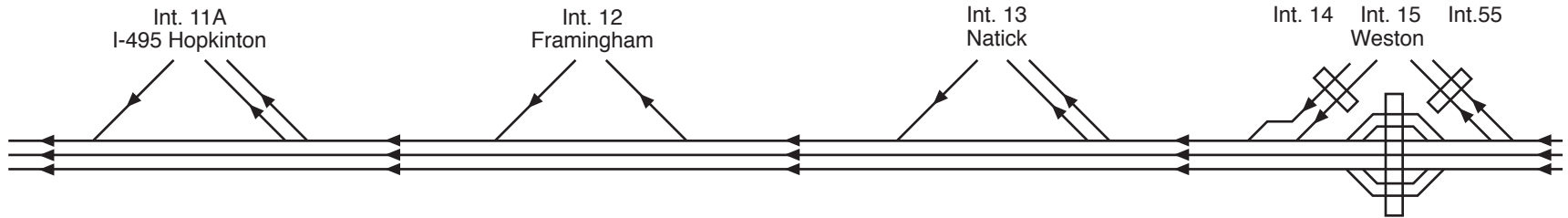


### 9-10 AM

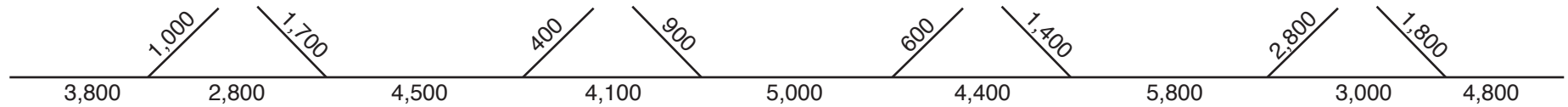


# I-90/Mass Turnpike Westbound: I-95/Route 128, Weston, to I-495, Hopkinton PM Peak Period Traffic Flow Diagrams: 2010

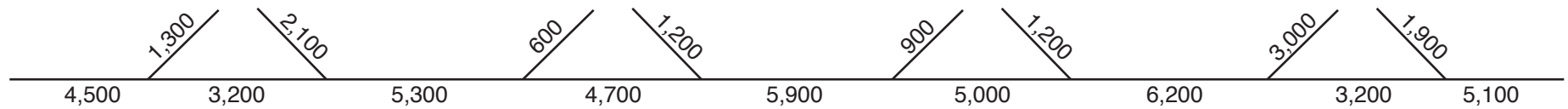
## Route/Lane Schematic



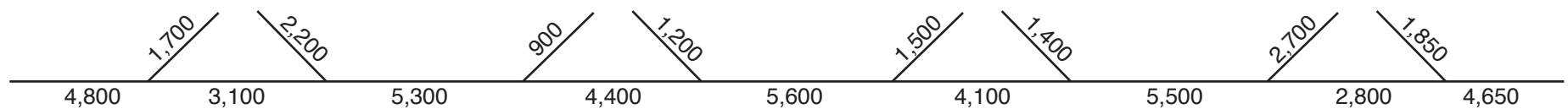
### 3-4 PM



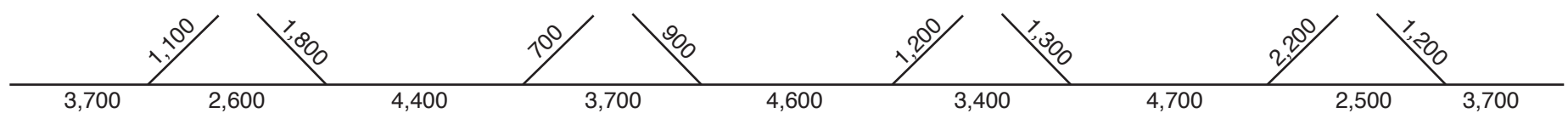
### 4-5 PM



### 5-6 PM



### 6-7 PM

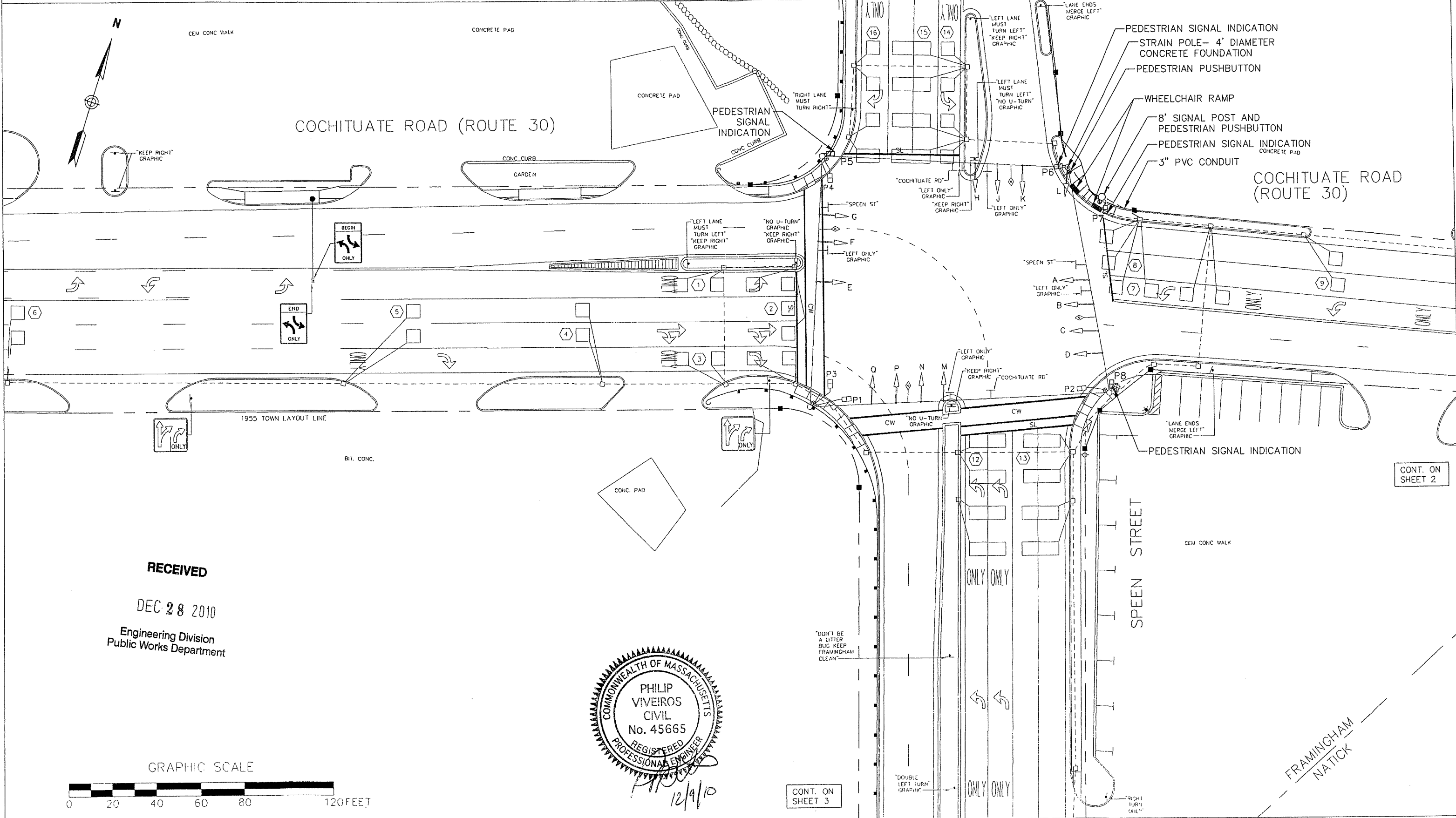


# **Appendix B: Traffic Signal Timing Information and As-Built Traffic Signal Plans**

SKETCH LOCATION OF TRAFFIC CONTROL SIGNALS

Town of Framingham  
Selectment's Office  
0 Concord Street, Framingham, Massachusetts

TOWN: Framingham  
LOCATION: Cochituate Road (Route 30)  
at Speen Street  
Date: 12-9-10 Permit No.:

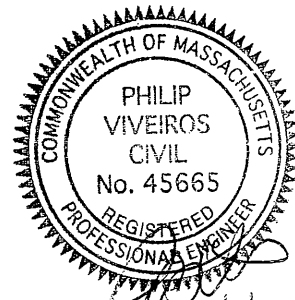


CONT. ON SHEET 2

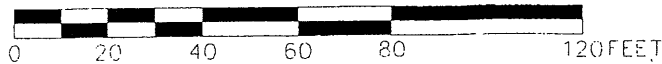
RECEIVED

DEC 28 2010

Engineering Division  
Public Works Department



GRAPHIC SCALE



CONT. ON SHEET 3

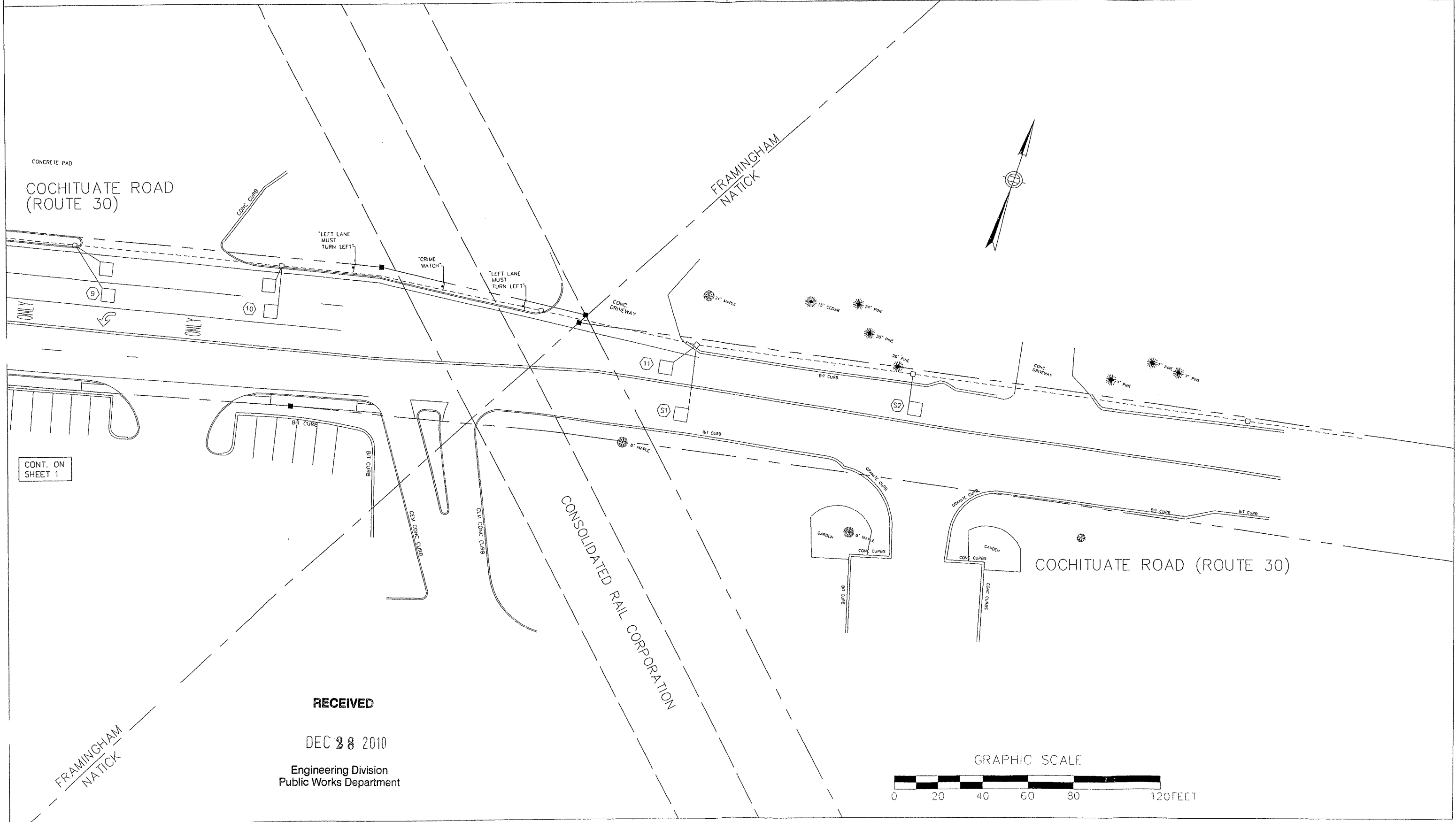
FRAMINGHAM  
NATICK



SKETCH LOCATION OF TRAFFIC CONTROL SIGNALS

Town of Framingham  
Selectment's Office  
150 Concord Street, Framingham, Massachusetts

TOWN: Framingham  
LOCATION: Cochituate Road (Route 30)  
at Speen Street  
Date: Permit No.:

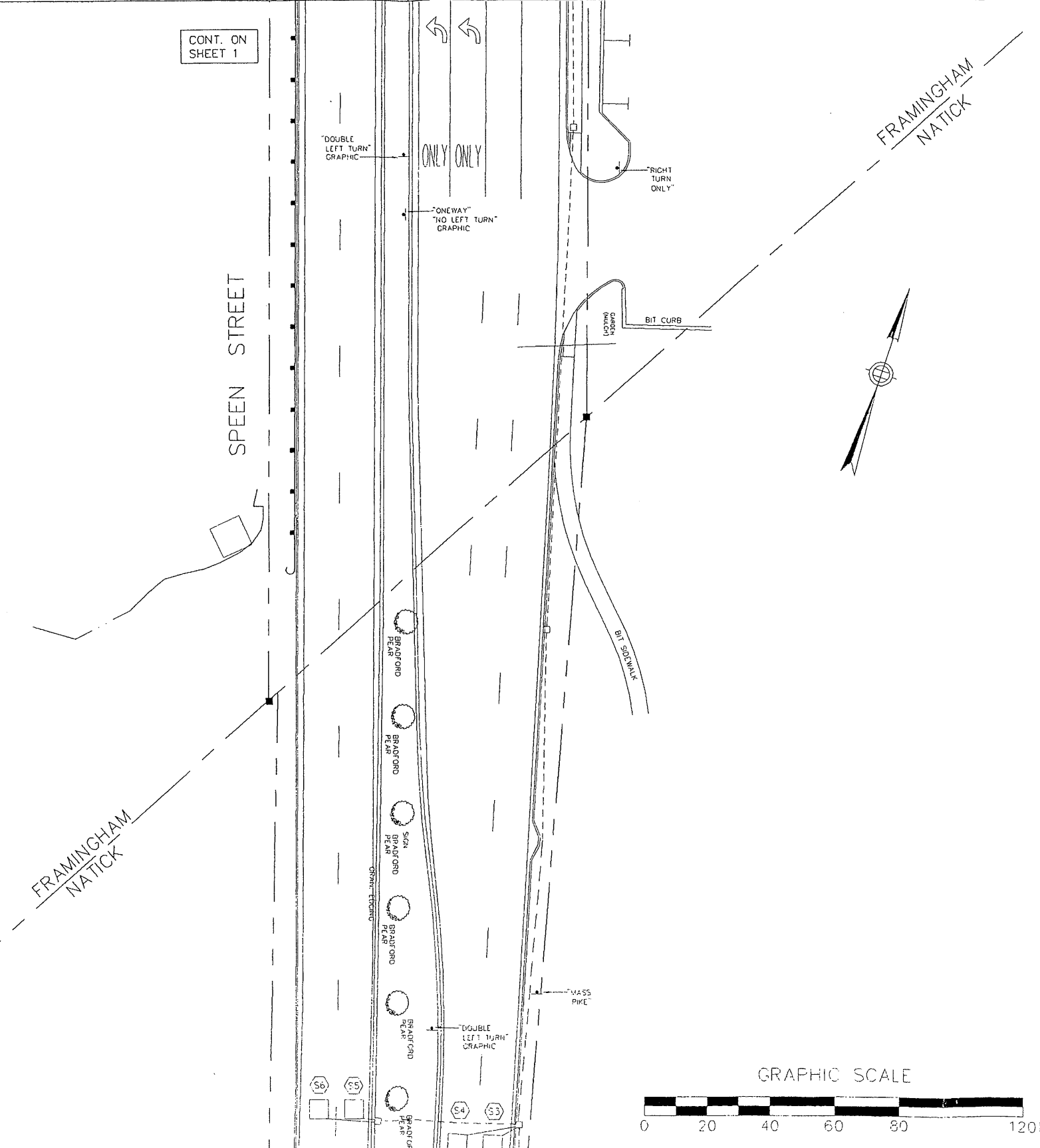


SKETCH LOCATION OF TRAFFIC CONTROL SIGNALS

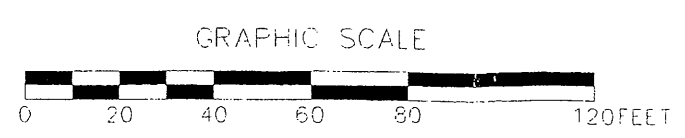
Town of Framingham  
Selectment's Office  
150 Concord Street, Framingham, Massachusetts

TOWN: Framingham  
LOCATION: Cochituate Road (Route 30)  
at Speen Street  
Date: Permit No.:

CONT. ON SHEET 1



RECEIVED  
DEC 28 2010  
Engineering Division  
Public Works Department



Town of Framingham  
 Selectment's Office  
 150 Concord Street, Framingham, Massachusetts

TOWN: Framingham  
 LOCATION: Cochituate Road (Route 30)  
 at Speen Street  
 Date: 12-9-10 Permit No.:

NOT PROGRAMMED

TABLE 1-1 COORDINATION DATA FOR LOCATION 14 - SPEEN STREET AT ROUTE 30

CYCLE	PURPOSE	CYCLE LENGTH IN SECONDS	SPLIT	OFFSET VALUE IN SECONDS
1	M 0700 am PEAK → F 1000 pm PEAK	102	1	15
2	M 1500 pm PEAK → F 1500 pm PEAK	102	2	29
2	SATURDAY 1000 → 1500 PEAK	102	2	29

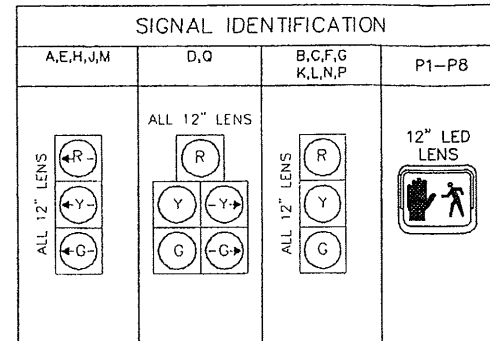
COORD POINT SHALL BE AT THE START OF THE GREEN OF THE FIRST PHASE, SHOWN BY \* BELOW.

MAXIMUM PHASE TIME IN SECONDS				
FUNCTION	PHASE 1 & 5	PHASE 1 & 6	PHASE 2 & 5	PHASE 2 & 6 *
SPLIT 1	19	-	13	22
SPLIT 2	16	7	-	28

MAXIMUM PHASE TIME IN SECONDS				
FUNCTION	PHASE 3 & 7	PHASE 4 & 7	PHASE 4 & 8	
SPLIT 1	14	20	14	
SPLIT 2	20	18	13	

TRAFFIC CONTROLLER DATA

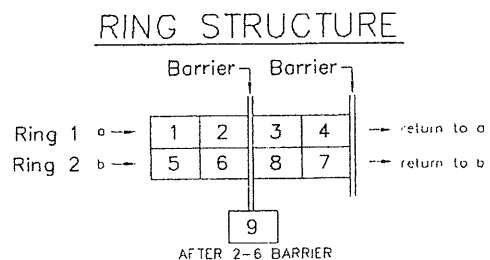
PARAMETER	SELECTION
PHASE ASSIGNMENTS	STD. NEMA
OVERLAPS	STD. NEMA
RINGS	DUAL
DUAL ENTRY	ON
SIMULTANEOUS GAP OUT DISABLED	YES (ø2 & ø6) (ø4 & ø7)
ALL RED REST	OFF
RED REVERT-# OF SECONDS	-
MINIMUM YELLOW IN SECONDS	3
MAX II BY INTERNAL CLOCK	YES
NIGHT TIME FLASH BY INTERNAL CLOCK	NOT USED
TYPE OF INTERCONNECT TO MASTER	WIRE
REMOTE MUTCD FLASH BY MASTER	YES
COORDINATION MODE	PERM
MAXIMUM MODE	INHIBIT
OFFSET SEEK METHOD	SHORTWAY



RECEIVED  
 DEC 28 2010  
 Engineering Division  
 Public Works Department

EMERGENCY VEHICLE PRE-EMPTION

PRE-EMPTION	PHASE CALL
EASTBOUND	ø2 & ø5
WESTBOUND	ø1 & ø6
NORTHBOUND	ø3 & ø7
SOUTHBOUND	ø4 & ø8



FULLY-ACTUATED <input checked="" type="checkbox"/>	ISOLATED <input type="checkbox"/>	ø1	ø2	ø3	ø4	ø5	ø6	ø7	ø8	ø9	
SEMI-ACTUATED <input type="checkbox"/>	COORDINATED <input checked="" type="checkbox"/>										
PRE-TIMED <input type="checkbox"/>	WIRE <input checked="" type="checkbox"/>										
	TBCU <input type="checkbox"/>										

SEQUENCE AND TIMING

STREET	DIRECTION	HOUSINGS	1	2	3	4	5	6	7	8	9	10	11	12	13	14	15	16	17	18	19	20	21	22	23	24	25	26	26	FLASH OPER.	
ROUTE 30	EB L	A	RL	RL	RL	RL	RL	RL	RL	RL	RL	RL	RL	RL	RL	RL	RL	RL	RL	RL	RL	RL	RL	RL	RL	RL	RL	RL	RL	FRL	
ROUTE 30	EB T	B,C	R	R	R	G	Y	R	R	R	R	R	R	R	R	R	R	R	R	R	R	R	R	R	R	R	R	R	R	FY	
ROUTE 30	EB R	D	R	R	R	G	Y	R	R/CRR/YR	R	R	R	R	R	R	R	R	R	R	R	R	R	R	R	R	R	R	R	R	FY	
ROUTE 30	WB L	E	GL	YL	RL	RL	RL	RL	RL	RL	RL	RL	RL	RL	RL	RL	RL	RL	RL	RL	RL	RL	RL	RL	RL	RL	RL	RL	RL	FRL	
ROUTE 30	WB T+R	F,G	R	R	R	R	R	R	R	R	R	R	R	R	R	R	R	R	R	R	R	R	R	R	R	R	R	R	R	FRL	
SPEEN STREET	NB L	H,J	RL	RL	RL	RL	RL	RL	GL	YL	RL	RL	RL	RL	RL	RL	RL	RL	RL	RL	RL	RL	RL	RL	RL	RL	RL	RL	RL	FRL	
SPEEN STREET	NB T+R	K,L	R	R	R	R	R	R	R	R	R	R	R	R	R	R	R	R	R	R	R	R	R	R	R	R	R	R	R	R	FR
SPEEN STREET	SB L	M	RL	RL	RL	RL	RL	RL	RL	RL	RL	RL	RL	RL	RL	RL	RL	RL	RL	RL	RL	RL	RL	RL	RL	RL	RL	RL	RL	FRL	
SPEEN STREET	SB T	N,P	R	R	R	R	R	R	R	R	R	R	R	R	R	R	R	R	R	R	R	R	R	R	R	R	R	R	R	FR	
SPEEN STREET	SB R	O	R	R	R	R	R	R	R	R	R	R	R	R	R	R	R	R	R	R	R	R	R	R	R	R	R	R	R	FR	
PEDESTRIAN	ALL	P1-P8	DW	DW	DW	DW	DW	DW	DW	DW	DW	DW	DW	DW	DW	DW	DW	DW	DW	DW	DW	DW	DW	DW	DW	DW	DW	DW	DW	OUT	

TIMING IN SECONDS

MINIMUM INITIAL	5	5	5	5	5	5	5	5	5	5	5	5	5	5	5	5	5	5	5	5	5	5	5	5	5	5	5	5	5	
PASSAGE	2	2	2	2	2	2	2	2	2	2	2	2	2	2	2	2	2	2	2	2	2	2	2	2	2	2	2	2	2	
MAXIMUM 1 (FREE OPERATION)	40	32	35	35	20	32	20	35	30	30	30	30	30	30	30	30	30	30	30	30	30	30	30	30	30	30	30	30		
MAXIMUM 2 (COORDINATED OPERATION)	30	3.5	2	4.5	2	3.5	2	4	2	3.5	2	4.5	2	4	2	3.5	2	4.5	2	4	2	3.5	2	4.5	2	4	2	3.5		
CHANGE																														
PEDESTRIAN		OFF	SOFT	OFF	OFF	OFF	OFF	OFF	OFF	OFF	OFF	OFF	OFF	OFF	OFF	OFF	OFF	OFF	OFF	OFF	OFF	OFF	OFF	OFF	OFF	OFF	OFF	OFF	OFF	
RECALL		NON-LOCKING	NON-LOCKING	NON-LOCKING	NON-LOCKING	NON-LOCKING	NON-LOCKING	NON-LOCKING	NON-LOCKING	NON-LOCKING	NON-LOCKING	NON-LOCKING	NON-LOCKING	NON-LOCKING	NON-LOCKING	NON-LOCKING	NON-LOCKING	NON-LOCKING	NON-LOCKING	NON-LOCKING	NON-LOCKING	NON-LOCKING	NON-LOCKING	NON-LOCKING	NON-LOCKING	NON-LOCKING	NON-LOCKING	NON-LOCKING		
MEMORY																														

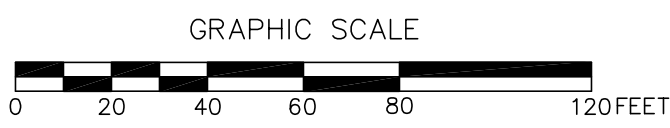
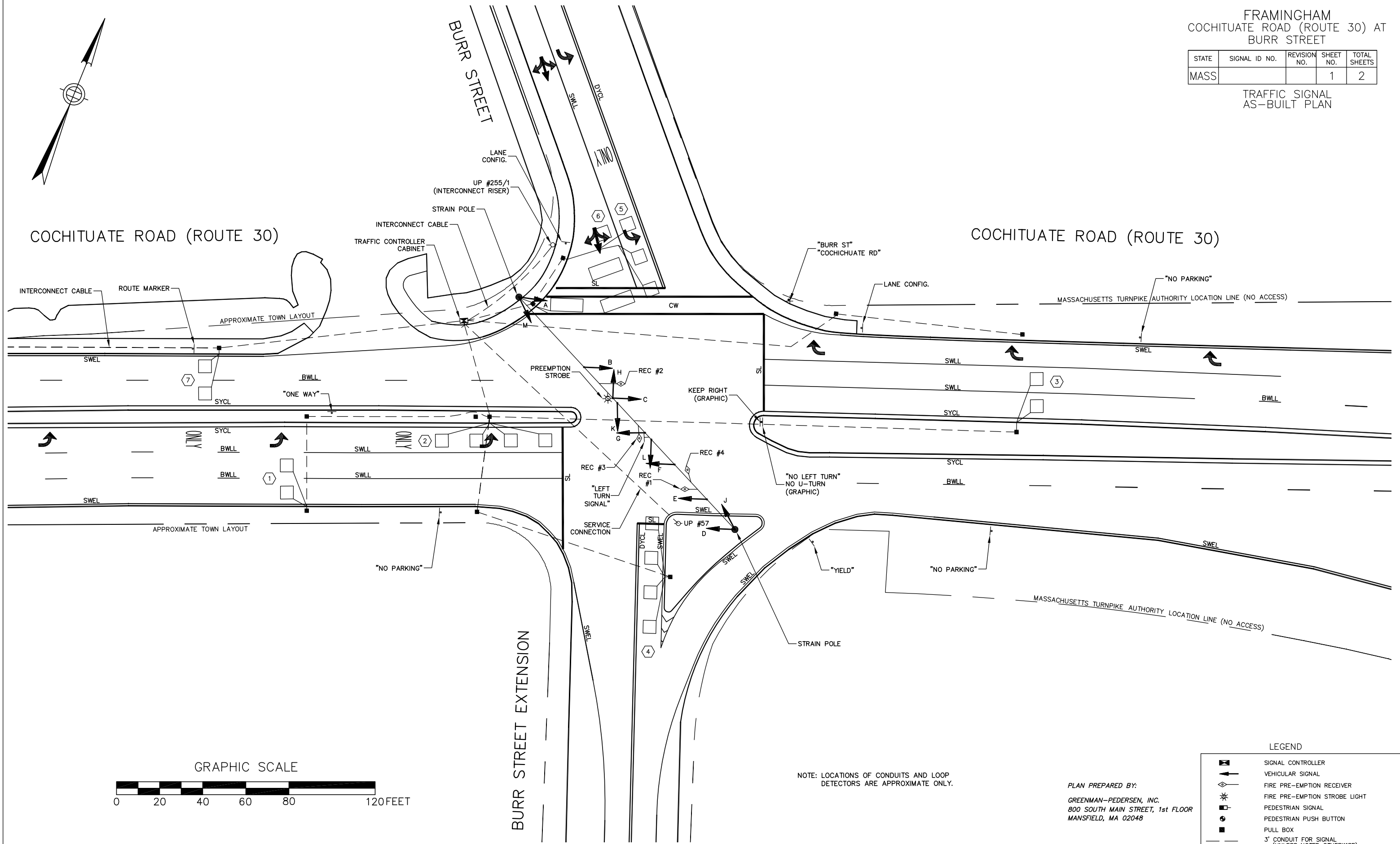
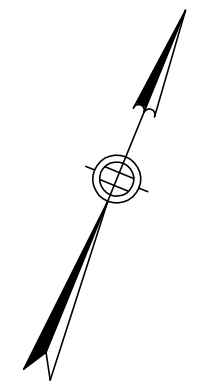
LOOP DETECTOR DATA

DETECTOR NO.	NO. OF SEGMENTS	LOOP SIZE	SPLICE PATTERN	NO. OF TURNS	ø CALLED	ø EXT.	MODE A=PULSE B=PRES.	DELAY TIME	EXT. TIME	
1	4	6'x6'	S	3	5	5	B	-	-	
2	2	6'x6'	S	3	2	2	B	-	-	
3	4	6'x6'	P	4	2	2	B	6	-	
4	2	6'x6'	S	3	2	2	A	-	-	
5	2	6'x6'	S	3	2	2	A	-	-	
6	2	6'x6'	S	3	2	2	A	-	2	
7	4	6'x6'	P	3	1	1	B	-	-	
8	2	6'x6'	S	3	6	6	B	-	-	
9	2	6'x6'	S	3	6	6	A	-	-	
10	2	6'x6'	S	3	6	6	A	-	-	
11	1	6'x6'	S	3	6	6	A	-	2	
12	4	6'x16'	P	3	3	3	B	-	-	
13	4	6'x17'	P	3	7	7	B	-	-	
14	4	6'x6'	S	3	8	8	B	-	-	
15	4	6'x17'	S	3	4	4	B	-	-	
16	4	1-6'x10' 3-6'x6'	S	3	4	4	B	6	-	
S1	1	6'x6'					SYSTEM DETECTORS	A	-	-
S2	1	6'x6'					SYSTEM DETECTORS	A	-	-
S3	1	6'x6'					SYSTEM DETECTORS	A	-	-
S4	1	6'x6'					SYSTEM DETECTORS	A	-	-
S5	1	6'x6'					SYSTEM DETECTORS	A	-	-
S6	1	6'x6'					SYSTEM DETECTORS	A	-	-

FRAMINGHAM  
COCHITUATE ROAD (ROUTE 30) AT  
BURR STREET

STATE	SIGNAL ID NO.	REVISION NO.	SHEET NO.	TOTAL SHEETS
MASS			1	2

TRAFFIC SIGNAL  
AS-BUILT PLAN



NOTE: LOCATIONS OF CONDUITS AND LOOP DETECTORS ARE APPROXIMATE ONLY.

PLAN PREPARED BY:  
GREENMAN-PEDERSEN, INC.  
800 SOUTH MAIN STREET, 1st FLOOR  
MANSFIELD, MA 02048

LEGEND

	SIGNAL CONTROLLER
	VEHICULAR SIGNAL
	FIRE PRE-EMPTION RECEIVER
	FIRE PRE-EMPTION STROBE LIGHT
	PEDESTRIAN SIGNAL
	PEDESTRIAN PUSH BUTTON
	PULL BOX
	3' CONDUIT FOR SIGNAL (UNLESS NOTED OTHERWISE)

LOCATION NO. 1  
COCHITUATE ROAD (ROUTE 30) @ BURR STREET  
(LOCAL)

FRAMINGHAM  
COCHITUATE ROAD (ROUTE 30) AT  
BURR STREET

STATE	SIGNAL ID NO.	REVISION NO.	SHEET NO.	TOTAL SHEETS
MASS			2	2

TRAFFIC SIGNAL DATA

FULLY-ACTUATED <input checked="" type="checkbox"/>	ISOLATED <input type="checkbox"/>	Ø2	Ø3	Ø4	Ø5	Ø6	
SEMI-ACTUATED <input type="checkbox"/>	COORDINATED <input checked="" type="checkbox"/>						
PRE-TIMED <input type="checkbox"/>	WIRE <input checked="" type="checkbox"/>						

SEQUENCE AND TIMING

STREET	DIRECTION	HOUSINGS	1	2	3	4	5	6	7	8	9	10	11	12	13	14	15	FLASH OPER.	
ROUTE 30	WB	A	R	R	R	R	R	R	R	R	R	R	R	R	R	G	Y	R	FY
ROUTE 30	WB	B,C	R	R	R	R	R	R	R	R	R	R	R	R	R	GV	Y	R	FY
ROUTE 30	EB	D	G	Y	R	R	R	R	R	R	R	R	R	R	R	R	R	R	FY
ROUTE 30	EB	E,F	GV	Y	R	R	R	R	R	R	R	R	R	R	R	R	R	R	FY
ROUTE 30	EB	G	RL	RL	RL	RL	RL	RL	RL	RL	RL	GL	YL	RL	RL	RL	RL	FRL	
BURR STREET	SB	H	R	R	R	G	Y	R	R	R	R	R	R	R	R	R	R	R	FR
BURR STREET	SB	J	R	R	R	GL/G	Y	R	R	R	R	R	R	R	R	R	R	R	FR
BURR STREET EXT.	NB	K,L	R	R	R	R	R	R	G	Y	R	R	R	R	R	R	R	R	FR
BURR STREET EXT.	NB	M	R	R	R	R	R	R	GL/G	Y	R	R	R	R	R	R	R	R	FR

TIMING IN SECONDS

	12	6	6	6	12	EMERGENCY
MINIMUM INITIAL	12	6	6	6	12	
PASSAGE	2	2	2	2	2	
MAXIMUM 1	65	20	20	20	40	
MAXIMUM 2	*	*	*	*	*	
CHANGE		3	2	3	2	
PEDESTRIAN						
RECALL	SOFT		OFF		OFF	
MEMORY	NON-LOCKING		NON-LOCKING		NON-LOCKING	

\* SEE COORDINATION DATA TABLE FOR SPLITS

EMERGENCY VEHICLE PRE-EMPTION

DIRECTION	PHASE CALL
EB - REC#1	Ø2 & Ø5
WB - REC#2	Ø6
NB - REC#3	Ø4
SB - REC#4	Ø3

COORDINATION DATA FOR INTERSECTION 1  
ROUTE 30 (SUB-SYSTEM)

FUNCTION	PURPOSE	OFFSET VALUE IN SECONDS	CYCLE LENGTH
OFFSET 1	COORDINATED PATTERN NO. 1	60	80
OFFSET 2	COORDINATED PATTERN NO. 2	69	110
OFFSET 3	COORDINATED PATTERN NO. 3	71	110

COORD POINT SHALL BE AT THE START OF THE YELLOW OF THE FIRST PHASE, SHOWN BY \* BELOW.

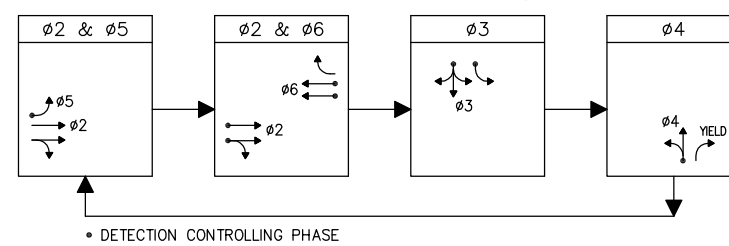
MAXIMUM PHASE TIME IN SECONDS

FUNCTION	PHASE 2 *	PHASE 3	PHASE 4	PHASE 5	PHASE 6 *
SPLIT 1	56	13	11	11	45
SPLIT 2	79	19	12	25	54
SPLIT 3	76	20	14	16	60

SIGNAL IDENTIFICATIONS

A,D,H,K,L	B,C,E,F	G	J,M
ALL 12" LENS 	ALL 12" LENS 	ALL 12" LENS 	ALL 12" LENS 

PREFERENTIAL PHASE SEQUENCE



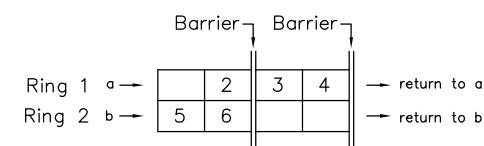
MAJOR ITEMS

QUANTITY	DESCRIPTION
1	CONTROLLER & CAB. TYPE 8DW W/FDN. MODEL: EAGLE EPAC 300
1	SERVICE CONNECTION
2	STRAIN POLE W/SPAN WIRE ASSEMBLY
10	SIGNAL HEAD, 3 SECTION
2	SIGNAL HEAD, 4 SECTION
21	ROADWAY LOOP DETECTOR (INCLUDED SYSTEM DETECTORS)
5	DUAL CHANNEL LOOP DETECTOR AMPLIFIER
11	PULL BOX 12" x 12"
1	OPTICOM SYSTEM CHASSIS
2	OPTICOM DUAL CHANNEL PHASE SELECTOR
1	OPTICOM PREEMPTION CONFIRMATION
4	OPTICOM UNIDIRECTIONAL SINGLE CHANNEL OPTICAL DETECTOR

PLUS ALL MISCELLANEOUS EQUIPMENT AND MATERIAL NECESSARY TO PROVIDE A COMPLETE OPERATING TRAFFIC CONTROL SIGNAL.

UTILITY POLE NO. 57  
METER NO. 54 938 974

RING STRUCTURE



LOOP DETECTOR DATA

DETECTOR NO.	NO. OF SEGMENTS	LOOP SIZE	Ø CALLED	Ø EXT.	MODE A=PULSE B=PRES.	DELAY TIME	EXT. TIME
1	2	6'x6'	2	2	B	0	0
2	4	6'x6'	5	5	B	0	0
3	2	6'x6'	6	6	B	0	0
4	4	6'x6'	4	4	B	0	0
5	3	6'x6'	3	3	B	0	0
6	4	VARIES	3	3	B	0	0
7	2	6'x6'	SYSTEM		A	0	0

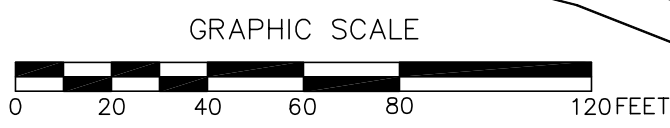
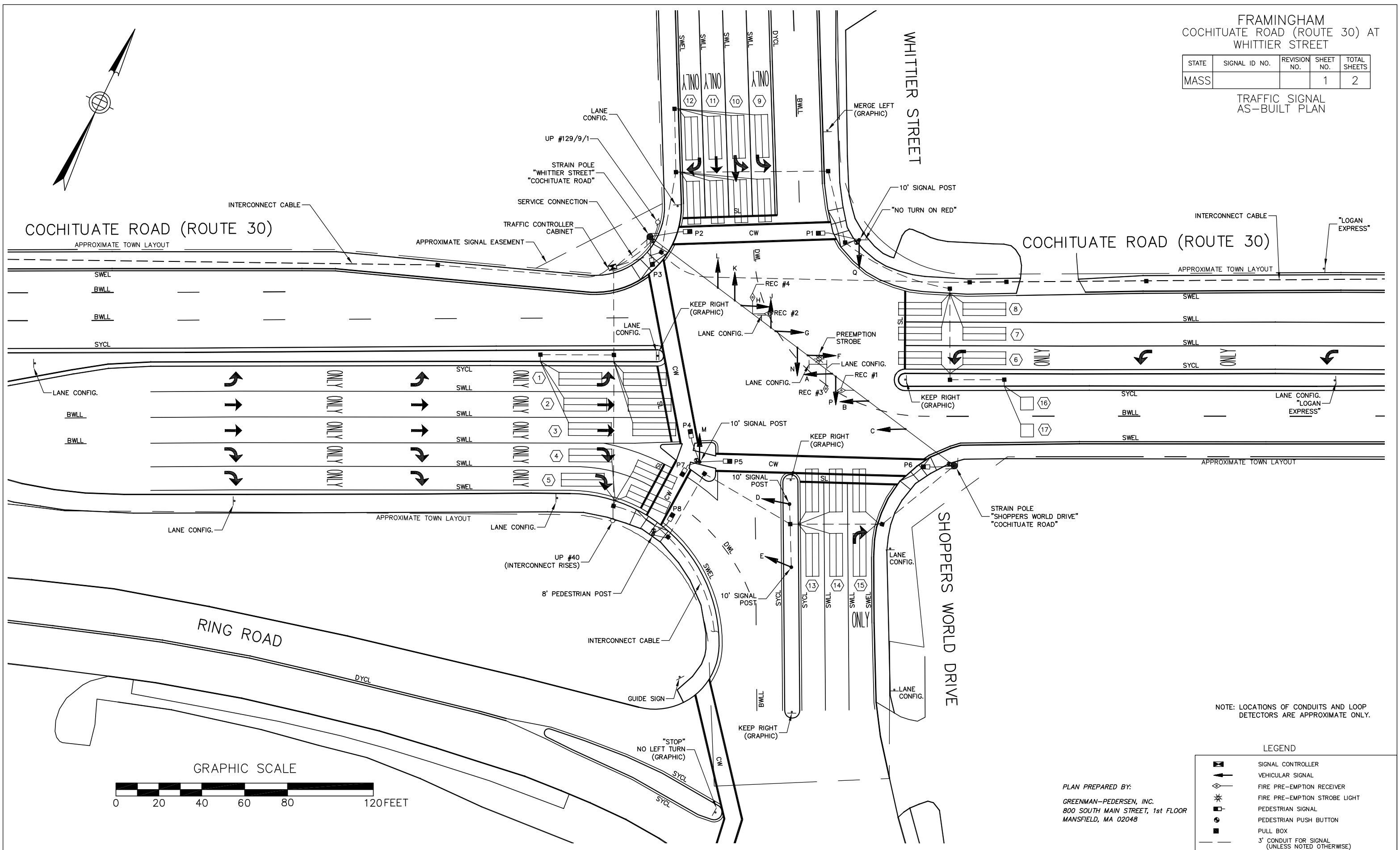
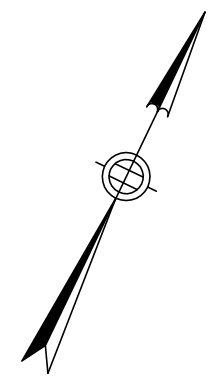
PLAN PREPARED BY:  
GREENMAN-PEDERSEN, INC.  
800 SOUTH MAIN STREET, 1st FLOOR  
MANSFIELD, MA 02048



FRAMINGHAM  
COCHITUATE ROAD (ROUTE 30) AT  
WHITTIER STREET

STATE	SIGNAL ID NO.	REVISION NO.	SHEET NO.	TOTAL SHEETS
MASS			1	2

TRAFFIC SIGNAL  
AS-BUILT PLAN



NOTE: LOCATIONS OF CONDUITS AND LOOP DETECTORS ARE APPROXIMATE ONLY.

LEGEND

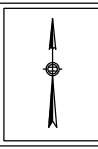
	SIGNAL CONTROLLER
	VEHICULAR SIGNAL
	FIRE PRE-EMPTION RECEIVER
	FIRE PRE-EMPTION STROBE LIGHT
	PEDESTRIAN SIGNAL
	PEDESTRIAN PUSH BUTTON
	PULL BOX
	3' CONDUIT FOR SIGNAL (UNLESS NOTED OTHERWISE)

PLAN PREPARED BY:  
GREENMAN-PEDERSEN, INC.  
800 SOUTH MAIN STREET, 1st FLOOR  
MANSFIELD, MA 02048

LOCATION NO. 2  
COCHITUATE ROAD (ROUTE 30) @ WHITTIER STREET  
(MASTER)

FRAMINGHAM  
COCHITUATE ROAD (ROUTE 30) AT  
WHITTIER STREET

FULLY-ACTUATED <input checked="" type="checkbox"/>	ISOLATED <input type="checkbox"/>	$\phi 1$	$\phi 2$	$\phi 3$	$\phi 4$	$\phi 5$	$\phi 6$	$\phi 9$
SEMI-ACTUATED <input type="checkbox"/>	COORDINATED <input checked="" type="checkbox"/>							
PRE-TIMED <input type="checkbox"/>	WIRE <input checked="" type="checkbox"/> TBCU <input type="checkbox"/>							



STATE	SIGNAL ID NO.	REVISION NO.	SHEET NO.	TOTAL SHEETS
MASS			2	2

TRAFFIC SIGNAL DATA

SEQUENCE AND TIMING

STREET	DIRECTION	HOUSINGS	1	2	3	4	5	6	7	8	9	10	11	12	13	14	15	16	17	18	19	20	21	FLASH OPER.
ROUTE 30	EB	A	GL	YL	RL	RL	RL	RL	RL	RL	RL	RL	RL	RL	RL	RL	RL	RL	RL	RL	RL	RL	RL	FRL
ROUTE 30	EB	B,C	R	R	R	R	R	R	R	R	R	R	R	R	R	R	R	R	R	R	R	R	R	FY
ROUTE 30	EB	D,E	RR	RR	RR	RR	RR	RR	RR	RR	RR	RR	RR	RR	RR	RR	RR	RR	RR	RR	RR	RR	RR	FYR
ROUTE 30	WB	F	RL	RL	RL	RL	RL	RL	RL	RL	RL	RL	RL	RL	RL	RL	RL	RL	RL	RL	RL	RL	RL	FRL
ROUTE 30	WB	G,H	R	R	R	R	R	R	R	R	R	R	R	R	R	R	R	R	R	R	R	R	R	FY
WHITTIER STREET	SB	J	RL	RL	RL	RL	RL	RL	RL	RL	RL	RL	RL	RL	RL	RL	RL	RL	RL	RL	RL	RL	RL	FRL
WHITTIER STREET	SB	K	R	R	R	R	R	R	R	R	R	R	R	R	R	R	R	R	R	R	R	R	R	FR
WHITTIER STREET	SB	L	R	R	R	R	R	R	R	R	R	R	R	R	R	R	R	R	R	R	R	R	R	FR
WHITTIER STREET	SB	M	GR	YR	RR	RR	RR	RR	RR	RR	RR	RR	RR	RR	RR	RR	RR	RR	RR	RR	RR	RR	RR	FRR
SHOPPERS WORLD DRIVE	NB	N	R	R	R	R	R	R	R	R	R	R	R	R	R	R	R	R	R	R	R	R	R	FR
SHOPPERS WORLD DRIVE	NB	P	R	R	R	R	R	R	R	R	R	R	R	R	R	R	R	R	R	R	R	R	R	FR
SHOPPERS WORLD DRIVE	NB	Q	RR	RR	RR	RR	RR	RR	RR	RR	RR	RR	RR	RR	RR	RR	RR	RR	RR	RR	RR	RR	RR	FRR
PEDESTRIAN	ALL	P1-P8	DW	DW	DW	DW	DW	DW	DW	DW	DW	DW	DW	DW	DW	DW	DW	DW	DW	DW	DW	DW	DW	OUT

TIMING IN SECONDS

MINIMUM INITIAL PASSAGE	6	6	6	6	6	6	6	6	6	6	6	6	6	6	6	6	6	6	6	6	6	6	6	6
MAXIMUM 1 (FREE OPERATION)	25	15	15	15	15	15	15	15	15	15	15	15	15	15	15	15	15	15	15	15	15	15	15	15
MAXIMUM 2 (COORDINATED OPERATION)	*	*	*	*	*	*	*	*	*	*	*	*	*	*	*	*	*	*	*	*	*	*	*	*
CHANGE	4	1	4	1	4	1	4	1	4	1	4	1	4	1	4	1	4	1	4	1	4	1	4	1
PEDESTRIAN	OFF	SOFT	OFF	OFF	OFF	OFF	OFF	OFF	OFF	OFF	OFF	OFF	OFF	OFF	OFF	OFF	OFF	OFF	OFF	OFF	OFF	OFF	OFF	OFF
RECALL	OFF	SOFT	OFF	OFF	OFF	OFF	OFF	OFF	OFF	OFF	OFF	OFF	OFF	OFF	OFF	OFF	OFF	OFF	OFF	OFF	OFF	OFF	OFF	OFF
MEMORY	NON-LOCKING	NON-LOCKING	NON-LOCKING	NON-LOCKING	NON-LOCKING	NON-LOCKING	NON-LOCKING	NON-LOCKING	NON-LOCKING	NON-LOCKING	NON-LOCKING	NON-LOCKING	NON-LOCKING	NON-LOCKING	NON-LOCKING	NON-LOCKING	NON-LOCKING	NON-LOCKING	NON-LOCKING	NON-LOCKING	NON-LOCKING	NON-LOCKING	NON-LOCKING	NON-LOCKING

\* SEE COORDINATION DATA TABLE FOR SPLITS

EMERGENCY VEHICLE PRE-EMPTION

DIRECTION	PHASE CALL
EB - REC#1	$\phi 1$ & $\phi 6$
WB - REC#2	$\phi 2$ & $\phi 5$
NB - REC#3	$\phi 3$
SB - REC#4	$\phi 4$

COORDINATION DATA FOR INTERSECTION 2  
ROUTE 30 (SUB-SYSTEM)

FUNCTION	PURPOSE	OFFSET VALUE IN SECONDS	CYCLE LENGTH
OFFSET 1	COORDINATED PATTERN NO. 1	0	80
OFFSET 2	COORDINATED PATTERN NO. 2	0	110
OFFSET 3	COORDINATED PATTERN NO. 3	0	110

COORD POINT SHALL BE AT THE START OF THE YELLOW OF THE FIRST PHASE, SHOWN BY \* BELOW.

FUNCTION	PHASE 1	PHASE 2 *	PHASE 3	PHASE 4	PHASE 5	PHASE 6	PHASE 9
SPLIT 1	12	13	13	13	12	13	29
SPLIT 2	24	27	14	16	12	39	29
SPLIT 3	25	22	15	19	12	35	29

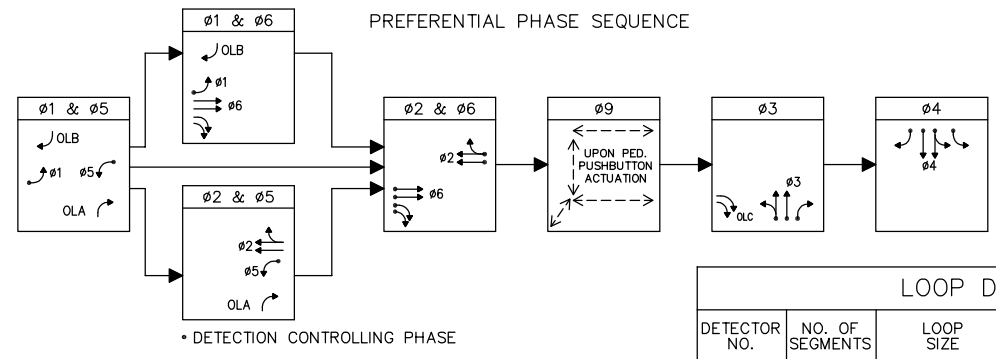
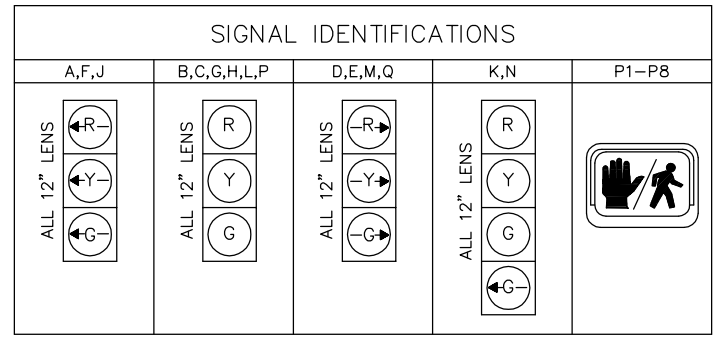
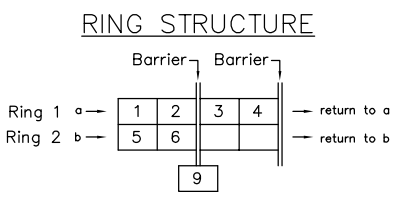


TABLE 1-M. MASTER PROGRAM - SUB-SYSTEM #1 - ROUTE 30  
INCLUDES INTERSECTIONS 1,2,3,4,5 & 6  
OWNED BY TOWN OF FRAMINGHAM

FUNCTION	MONDAY -> FRIDAY	SATURDAY	SUNDAYS & HOLIDAYS
FREE OPERATION FULLY ACTUATED	*	*	*
COORDINATED PATTERN NO. 1 CYCLE = 80 SEC.	6:00 am -> 12:00 pm		
COORDINATED PATTERN NO. 2 CYCLE = 110 SEC.	12:00 pm -> 7:00 pm		
COORDINATED PATTERN NO. 3 CYCLE = 110 SEC.		10:00 am -> 6:00 pm	11:00 am -> 5:00 pm

\* = DEFAULT. MASTER SHALL USE THIS FUNCTION UNLESS A TIME IS SHOWN FOR ANOTHER FUNCTION

FOR INITIAL OPERATION, CYCLE 1 INCLUDES SPLIT 1 + OFFSET 1, CYCLE 2 INCLUDES SPLIT 2 + OFFSET 2, CYCLE 3 INCLUDES SPLIT 3 + OFFSET 3, ETC.



LOOP DETECTOR DATA

DETECTOR NO.	NO. OF SEGMENTS	LOOP SIZE	$\phi$ CALLED	$\phi$ EXT.	MODE A=PULSE B=PRES.	DELAY TIME	EXT. TIME	
1	2	QUADRUPOLE	1	1	B	0	0	
2	2	QUADRUPOLE	6	6	B	0	0	
3	2	QUADRUPOLE	6	6	B	0	0	
4	2	QUADRUPOLE	6	6	B	0	0	
5	2	QUADRUPOLE	6	6	B	0	0	
6	2	QUADRUPOLE	5	5	B	0	0	
7	2	QUADRUPOLE	2	2	B	0	0	
8	2	QUADRUPOLE	2	2	B	0	0	
9	2	QUADRUPOLE	4	4	B	0	0	
10	2	QUADRUPOLE	4	4	B	0	0	
11	2	QUADRUPOLE	4	4	B	0	0	
12	2	QUADRUPOLE	4	4	B	0	0	
13	2	QUADRUPOLE	3	3	B	0	0	
14	2	QUADRUPOLE	3	3	B	0	0	
15	2	QUADRUPOLE	3	3	B	0	0	
16	1	6'x6'			SYSTEM	A	0	0
17	1	6'x6'			SYSTEM	A	0	0

MAJOR ITEMS

QUANTITY	DESCRIPTION
1	CONTROLLER & CAB. TYPE 8DW W/FDN. MODEL: EAGLE EPAC 300
1	SERVICE CONNECTION
2	STRAIN POLE W/SPAN WIRE ASSEMBLY
4	10' SIGNAL POST, BASE & FDN.
1	8' PEDESTRIAN POST, BASE & FDN.
13	SIGNAL HEAD, 3 SECTION
2	SIGNAL HEAD, 4 SECTION
8	PEDESTRIAN HOUSING, PUSH BUTTON, SIGN & SADDLE
32	ROADWAY LOOP DETECTOR (INCLUDED SYSTEM DETECTORS)
8	DUAL CHANNEL LOOP DETECTOR AMPLIFIER
19	PULL BOX 12" x 12"
1	OPTICOM SYSTEM CHASSIS
2	OPTICOM DUAL CHANNEL PHASE SELECTOR
1	OPTICOM PREEMPTION CONFIRMATION
4	OPTICOM UNIDIRECTIONAL SINGLE CHANNEL OPTICAL DETECTOR

PLUS ALL MISCELLANEOUS EQUIPMENT AND MATERIAL NECESSARY TO PROVIDE A COMPLETE OPERATING TRAFFIC CONTROL SIGNAL.  
UTILITY POLE No. 129/9/1  
METER No. 46 563 780

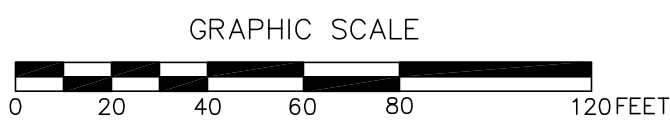
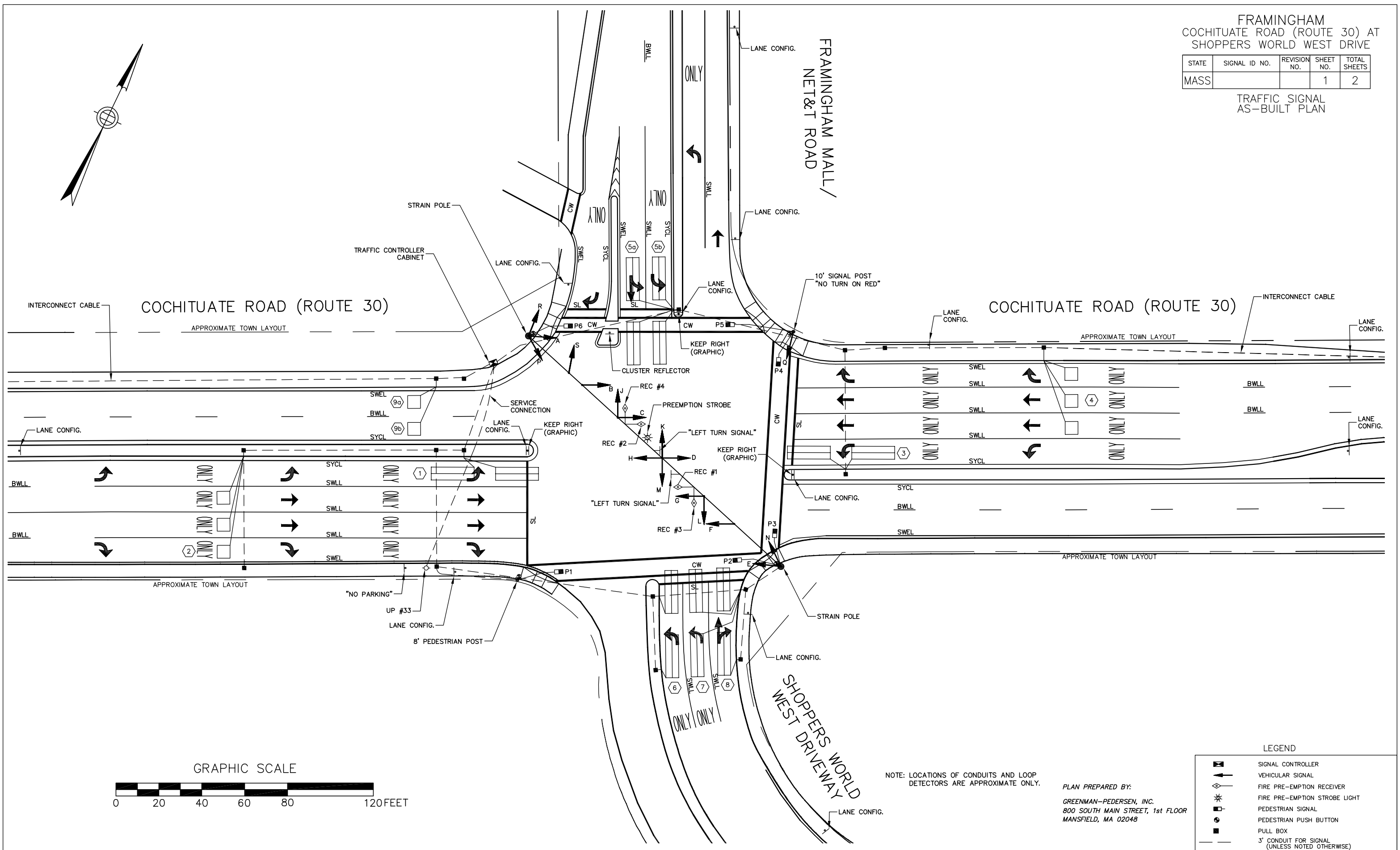
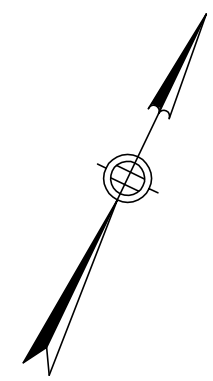
- LOCATION NO. 1 : ROUTE 30 @ BURR STREET - (LOCAL)
- LOCATION NO. 2 : ROUTE 30 @ WHITTIER STREET - (MASTER)
- LOCATION NO. 3 : ROUTE 30 @ SHOPPERS WORLD WEST DRIVEWAY - (LOCAL)
- LOCATION NO. 4 : ROUTE 30 @ CALDOR ROAD & POST OFFICE - (LOCAL)
- LOCATION NO. 5 : ROUTE 30 @ ROUTE 126 - (LOCAL)
- LOCATION NO. 6 : ROUTE 30 @ SPEEN STREET - (LOCAL)
- LOCATION NO. 7 : ROUTE 30 @ BEACON STREET - (LOCAL)

PLAN PREPARED BY:  
GREENMAN-PEDERSEN, INC.  
800 SOUTH MAIN STREET, 1st FLOOR  
MANSFIELD, MA 02048

FRAMINGHAM  
COCHITUATE ROAD (ROUTE 30) AT  
SHOPPERS WORLD WEST DRIVE

STATE	SIGNAL ID NO.	REVISION NO.	SHEET NO.	TOTAL SHEETS
MASS			1	2

TRAFFIC SIGNAL  
AS-BUILT PLAN



NOTE: LOCATIONS OF CONDUITS AND LOOP DETECTORS ARE APPROXIMATE ONLY.

PLAN PREPARED BY:  
GREENMAN-PEDERSEN, INC.  
800 SOUTH MAIN STREET, 1st FLOOR  
MANSFIELD, MA 02048

LEGEND

	SIGNAL CONTROLLER
	VEHICULAR SIGNAL
	FIRE PRE-EMPTION RECEIVER
	FIRE PRE-EMPTION STROBE LIGHT
	PEDESTRIAN SIGNAL
	PEDESTRIAN PUSH BUTTON
	PULL BOX
	3' CONDUIT FOR SIGNAL (UNLESS NOTED OTHERWISE)

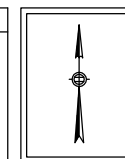
LOCATION NO. 3  
COCHITUATE ROAD (ROUTE 30) @ SHOPPERS WORLD WEST DRIVEWAY  
(LOCAL)

FRAMINGHAM  
COCHITUATE ROAD (ROUTE 30) AT  
SHOPPERS WORLD WEST DRIVE

STATE	SIGNAL ID NO.	REVISION NO.	SHEET NO.	TOTAL SHEETS
MASS			2	2

TRAFFIC SIGNAL DATA

FULLY-ACTUATED <input checked="" type="checkbox"/>	ISOLATED <input type="checkbox"/>		Ø1	Ø2	Ø4	Ø5	Ø6	Ø8	Ø9			
SEMI-ACTUATED <input type="checkbox"/>	COORDINATED <input checked="" type="checkbox"/>		↻	↻↻	↻↻↻	↻	↻↻	↻↻↻	↻↻↻↻	↻↻↻↻↻		
PRE-TIMED <input type="checkbox"/>	WIRE <input checked="" type="checkbox"/>	TBCU <input type="checkbox"/>									↻↻↻↻↻↻	↻↻↻↻↻↻



SEQUENCE AND TIMING

STREET	DIRECTION	HOUSINGS	1	2	3	4	5	6	7	8	9	10	11	12	13	14	15	16	17	18	19	20	21	FLASH OPER.
ROUTE 30	WB	A	RR	RR	RR	GR	YR	RR	GR	YR	RR	RR	RR	RR	RR	RR	RR	RR	RR	RR	RR	RR	RR	FYR
ROUTE 30	WB	B,C	R	R	R	G	Y	R	R	R	R	R	R	R	R	R	R	R	R	R	R	R	R	FY
ROUTE 30	WB	D	RL	RL	RL	RL	RL	RL	RL	RL	GL	YL	RL	RL	RL	RL	RL	RL	RL	RL	RL	RL	RL	FRL
ROUTE 30	EB	E	RR	RR	RR	RR	RR	RR	RR	RR	RR	RR	RR	RR	RR	RR	RR	RR	RR	RR	RR	RR	RR	FYR
ROUTE 30	EB	F,G	R	R	R	R	R	R	R	R	R	R	R	R	R	R	R	R	R	R	R	R	R	FY
ROUTE 30	EB	H	GL	YL	RL	RL	RL	RL	RL	RL	RL	RL	RL	RL	RL	RL	RL	RL	RL	RL	RL	RL	RL	FRL
F'HAM MALL/NET&T	SB	J,K,R,S	R	R	R	R	R	R	R	R	G	Y	R	R	R	R	R	R	R	R	R	R	R	FR
F'HAM MALL/NET&T	SB	N	RL	RL	RL	RL	RL	RL	RL	RL	GL	YL	RL	RL	RL	RL	RL	RL	RL	RL	RL	RL	RL	FRL
SHOPPERS WORLD	NB	L,M,Q	R	R	R	R	R	R	R	R	R	R	R	R	R	R	R	R	R	R	R	R	R	FR
SHOPPERS WORLD	NB	P	RL	RL	RL	RL	RL	RL	RL	RL	RL	RL	RL	RL	RL	RL	RL	RL	RL	RL	RL	RL	RL	FRL

		TIMING IN SECONDS																							
MINIMUM INITIAL		6			9				6				5				9				6				EMERGENCY
PASSAGE		2			6				2				2				6				2				
MAXIMUM 1		20			60				30				30				60				20				
MAXIMUM 2		*			*				*				*				*				*				
CHANGE			3.2	2.6		3.2	3.1			3.2	2.7			3.2	3.0			3.2	3.1			3.2	2.7		
PEDESTRIAN																						7	21		
RECALL		OFF			MIN			OFF			OFF			MIN			OFF			OFF					
MEMORY		NON-LOCKING			LOCK			NON-LOCKING			NON-LOCKING			LOCK			NON-LOCKING			LOCKING					

\* SEE COORDINATION DATA TABLE FOR SPLITS

EMERGENCY VEHICLE  
PRE-EMPTION

DIRECTION	PHASE CALL
EB - REC#1	Ø1 & Ø6
WB - REC#2	Ø2 & Ø5
NB - REC#3	Ø8
SB - REC#4	Ø4

COORDINATION DATA FOR INTERSECTION 3  
ROUTE 30 (SUB-SYSTEM)

FUNCTION	PURPOSE	OFFSET VALUE IN SECONDS	CYCLE LENGTH
OFFSET 1	COORDINATED PATTERN NO. 1	73	80
OFFSET 2	COORDINATED PATTERN NO. 2	108	110
OFFSET 3	COORDINATED PATTERN NO. 3	99	110

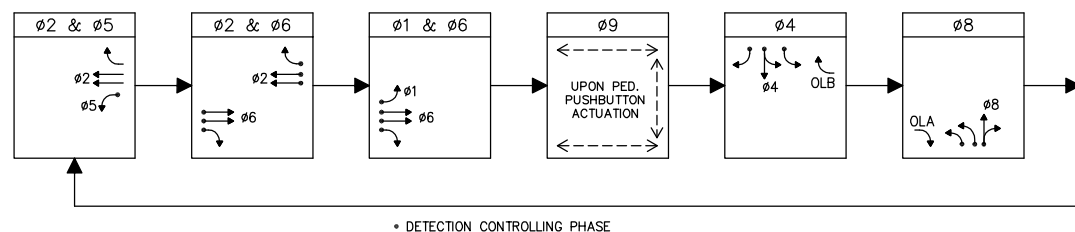
COORD POINT SHALL BE AT THE START OF THE YELLOW OF THE FIRST PHASE, SHOWN BY \* BELOW.

MAXIMUM PHASE TIME IN SECONDS

FUNCTION	PHASE 1	PHASE 2	PHASE 4	PHASE 5	PHASE 6 *	PHASE 8	PHASE 9
SPLIT 1	12	16	12	12	16	12	28
SPLIT 2	12	43	13	15	40	13	29
SPLIT 3	18	37	13	23	32	13	29

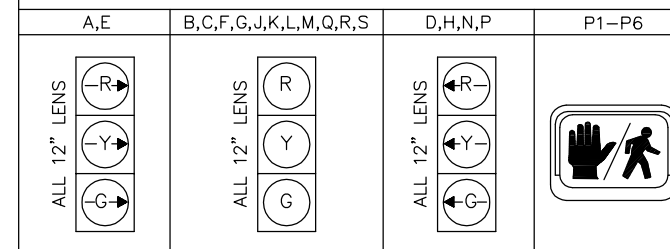
NOTE: Ø2 & Ø6 MIN. GREEN TIMES SHALL BE 9 SEC.

PREFERENTIAL PHASE SEQUENCE



\* DETECTION CONTROLLING PHASE

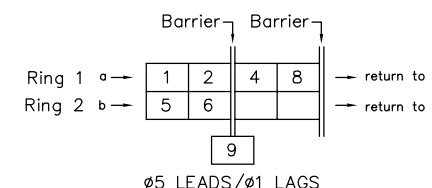
SIGNAL IDENTIFICATIONS



LOOP DETECTOR DATA

DETECTOR NO.	NO. OF SEGMENTS	LOOP SIZE	Ø CALLED	Ø EXT.	MODE A=PULSE B=PRES.	DELAY TIME	EXT. TIME
1	2	QUADRUPOLE	1	1	B	0	0
2	3	6'x6'	6	6	B	0	0
3	2	QUADRUPOLE	5	5	B	0	0
4	3	6'x6'	2	2	B	0	0
5a	2	QUADRUPOLE	4	4	B	0	0
5b	2	QUADRUPOLE	4	4	B	0	0
6	2	QUADRUPOLE	8	8	B	0	0
7	2	QUADRUPOLE	8	8	B	0	0
8	2	QUADRUPOLE	8	8	B	0	0
9a	1	6'x6'	SYSTEM		A	0	0
9b	1	6'x6'	SYSTEM		A	0	0

RING STRUCTURE



MAJOR ITEMS	
QUANTITY	DESCRIPTION
1	CONTROLLER & CAB. TYPE 8DW W/FDN. MODEL: EAGLE EPAC 300
1	SERVICE CONNECTION
2	STRAIN POLE W/SPAN WIRE ASSEMBLY
1	8' PEDESTRIAN POST, BASE & FDN.
1	10' SIGNAL POST, BASE & FDN.
17	SIGNAL HEAD, 3 SECTION
6	PEDESTRIAN HOUSING, PUSH BUTTON, SIGN & SADDLE
22	ROADWAY LOOP DETECTOR (INCLUDED SYSTEM DETECTORS)
5	DUAL CHANNEL LOOP DETECTOR AMPLIFIER
16	PULL BOX 12" x 12"
1	OPTICOM SYSTEM CHASSIS
2	OPTICOM DUAL CHANNEL PHASE SELECTOR
1	OPTICOM PREEMPTION CONFIRMATION
4	OPTICOM UNIDIRECTIONAL SINGLE CHANNEL OPTICAL DETECTOR

PLUS ALL MISCELLANEOUS EQUIPMENT AND MATERIAL NECESSARY TO PROVIDE A COMPLETE OPERATING TRAFFIC CONTROL SIGNAL.

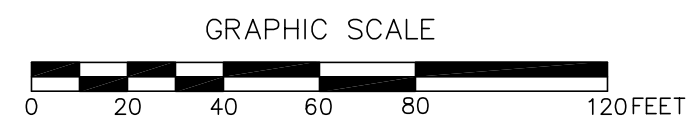
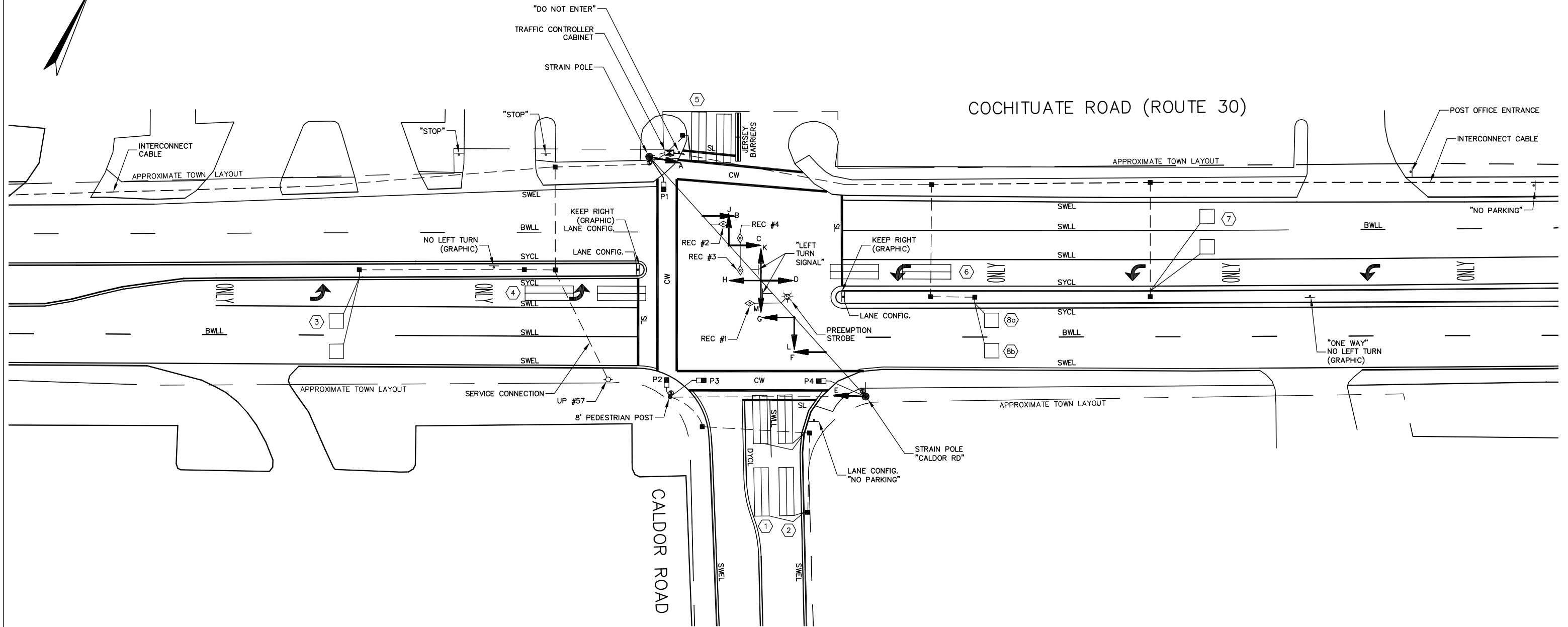
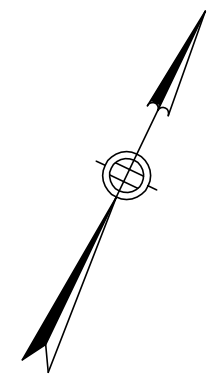
UTILITY POLE No. 33  
METER No. 38 771 732

PLAN PREPARED BY:  
GREENMAN-PEDERSEN, INC.  
800 SOUTH MAIN STREET, 1st FLOOR  
MANSFIELD, MA 02048

FRAMINGHAM  
COCHITUATE ROAD (ROUTE 30) AT  
CALDOR ROAD

STATE	SIGNAL ID NO.	REVISION NO.	SHEET NO.	TOTAL SHEETS
MASS			1	2

TRAFFIC SIGNAL  
AS-BUILT PLAN



NOTE: LOCATIONS OF CONDUITS AND LOOP DETECTORS ARE APPROXIMATE ONLY.

PLAN PREPARED BY:  
GREENMAN-PEDERSEN, INC.  
800 SOUTH MAIN STREET, 1st FLOOR  
MANSFIELD, MA 02048

LEGEND

	SIGNAL CONTROLLER
	VEHICULAR SIGNAL
	FIRE PRE-EMPTION RECEIVER
	FIRE PRE-EMPTION STROBE LIGHT
	PEDESTRIAN SIGNAL
	PEDESTRIAN PUSH BUTTON
	PULL BOX
	3' CONDUIT FOR SIGNAL (UNLESS NOTED OTHERWISE)



LOCATION NO. 4  
COCHITUATE ROAD (ROUTE 30) @ CALDOR ROAD  
(LOCAL)

FRAMINGHAM  
COCHITUATE ROAD (ROUTE 30) AT  
CALDOR ROAD

STATE	SIGNAL ID NO.	REVISION NO.	SHEET NO.	TOTAL SHEETS
MASS			2	2

TRAFFIC SIGNAL DATA

FULLY-ACTUATED <input checked="" type="checkbox"/>	ISOLATED <input type="checkbox"/>	Ø1	Ø2	Ø4	Ø5	Ø6	Ø8	Ø9	
SEMI-ACTUATED <input type="checkbox"/>	COORDINATED <input checked="" type="checkbox"/>								
PRE-TIMED <input type="checkbox"/>	WIRE <input checked="" type="checkbox"/> TBCU <input type="checkbox"/>								

EMERGENCY VEHICLE  
PRE-EMPTION

DIRECTION	PHASE CALL
EB - REC#1	Ø1 & Ø6
WB - REC#2	Ø2 & Ø5
NB - REC#3	Ø8
SB - REC#4	Ø4

SEQUENCE AND TIMING

STREET	DIRECTION	HOUSINGS	1	2	3	4	5	6	7	8	9	10	11	12	13	14	15	16	17	18	19	20	21	FLASH OPER.		
ROUTE 30	WB	A,B,C	R	R	R	G	Y	R	R	R	R	R	R	R	R	R	R	R	R	R	R	R	R	R	FY	
ROUTE 30	WB	D	RL	RL	RL	RL	RL	RL	RL	RL	RL	GL	YL	RL	RL	RL	RL	RL	RL	RL	RL	RL	RL	RL	FRL	
ROUTE 30	EB	E,F,G	R	R	R	R	R	R	R	R	R	R	R	R	G	Y	R	R	R	R	R	R	R	R	R	FY
ROUTE 30	EB	H	GL	YL	RL	RL	RL	RL	RL	RL	RL	RL	RL	RL	RL	RL	RL	RL	RL	RL	RL	RL	RL	RL	FRL	
POST OFFICE	SB	J,K	R	R	R	R	R	R	R	R	R	G	Y	R	R	R	R	R	R	R	R	R	R	R	FR	
CALDOR ROAD	NB	L	R	R	R	R	R	R	R	R	R	GR	Y	R	R	R	R	R	R	R	R	R	R	R	FR	
CALDOR ROAD	NB	M	R	R	R	R	R	R	R	R	R	R	R	R	G	Y	R	R	R	R	R	R	R	R	R	FR
PEDESTRIAN		P1-P4	DW	DW	DW	DW	DW	DW	DW	DW	DW	DW	DW	DW	DW	DW	DW	DW	DW	DW	DW	W	FDW	DW	OUT	

TIMING IN SECONDS		
MINIMUM INITIAL	4	12
PASSAGE	3	6
MAXIMUM 1	20	30
MAXIMUM 2	*	*
CHANGE	3	2
PEDESTRIAN	3	2
RECALL	OFF	MIN
MEMORY	NON-LOCKING	LOCK

\* SEE COORDINATION DATA TABLE FOR SPLITS

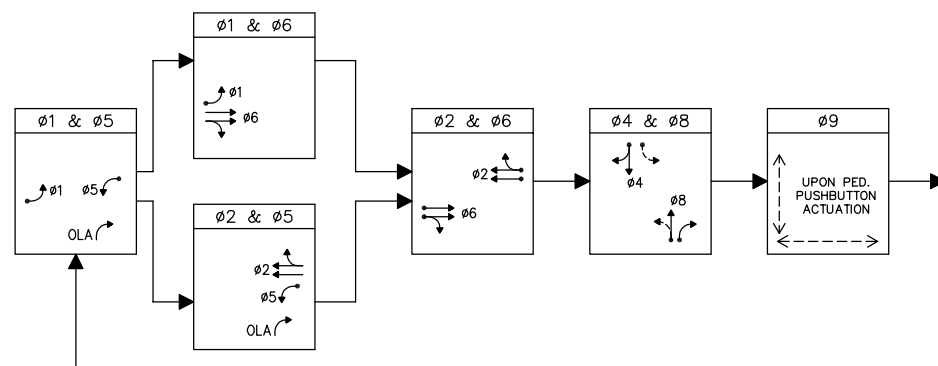
COORDINATION DATA FOR INTERSECTION 4  
ROUTE 30 (SUB-SYSTEM )

FUNCTION	PURPOSE	OFFSET VALUE IN SECONDS	CYCLE LENGTH
OFFSET 1	COORDINATED PATTERN NO. 1	40	80
OFFSET 2	COORDINATED PATTERN NO. 2	54	110
OFFSET 3	COORDINATED PATTERN NO. 3	68	110

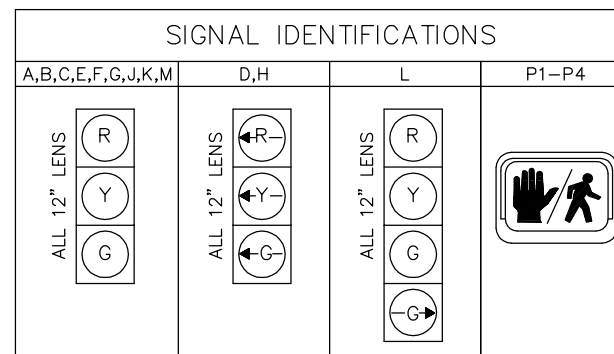
COORD POINT SHALL BE AT THE START OF THE YELLOW OF THE FIRST PHASE, SHOWN BY \* BELOW.

MAXIMUM PHASE TIME IN SECONDS							
FUNCTION	PHASE 1	PHASE 2 *	PHASE 4	PHASE 5	PHASE 6 *	PHASE 8	PHASE 9
SPLIT 1	17	23	19	11	29	19	21
SPLIT 2	28	25	36	22	43	36	21
SPLIT 3	29	33	27	15	47	27	21

PREFERENTIAL PHASE SEQUENCE



SIGNAL IDENTIFICATIONS

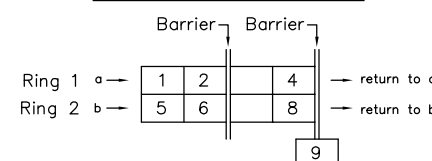


MAJOR ITEMS

QUANTITY	DESCRIPTION
1	CONTROLLER & CAB. TYPE 8DW W/FDN. MODEL: EAGLE EPAC 300
1	SERVICE CONNECTION
2	STRAIN POLE W/SPAN WIRE ASSEMBLY
1	8' PEDESTRIAN POST, BASE & FDN.
11	SIGNAL HEAD, 3 SECTION
1	SIGNAL HEAD, 4 SECTION
4	PEDESTRIAN HOUSING, PUSH BUTTON, SIGN & SADDLE
16	ROADWAY LOOP DETECTOR (INCLUDED SYSTEM DETECTORS)
5	DUAL CHANNEL LOOP DETECTOR AMPLIFIER
13	PULL BOX 12" x 12"
1	OPTICOM SYSTEM CHASSIS
2	OPTICOM DUAL CHANNEL PHASE SELECTOR
1	OPTICOM PREEMPTION CONFIRMATION
4	OPTICOM UNIDIRECTIONAL SINGLE CHANNEL OPTICAL DETECTOR

PLUS ALL MISCELLANEOUS EQUIPMENT AND MATERIAL NECESSARY TO PROVIDE A COMPLETE OPERATING TRAFFIC CONTROL SIGNAL.

RING STRUCTURE



LOOP DETECTOR DATA

DETECTOR NO.	NO. OF SEGMENTS	LOOP SIZE	Ø CALLED	Ø EXT.	MODE A=PULSE B=PRES.	DELAY TIME	EXT. TIME
1	2	QUADRUPOLE	8	8	B	0	0
2	2	QUADRUPOLE	8	8	B	0	0
3	2	6'x6'	6	6	B	0	0
4	2	QUADRUPOLE	1	1	B	0	0
5	2	QUADRUPOLE	4	4	B	0	0
6	2	QUADRUPOLE	5	5	B	0	0
7	2	6'x6'	2	2	B	0	0
8a	1	6'x6'	SYSTEM		A	0	0
8b	1	6'x6'	SYSTEM		A	0	0

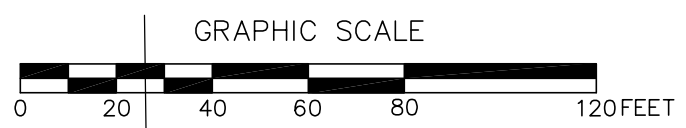
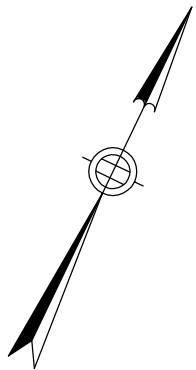
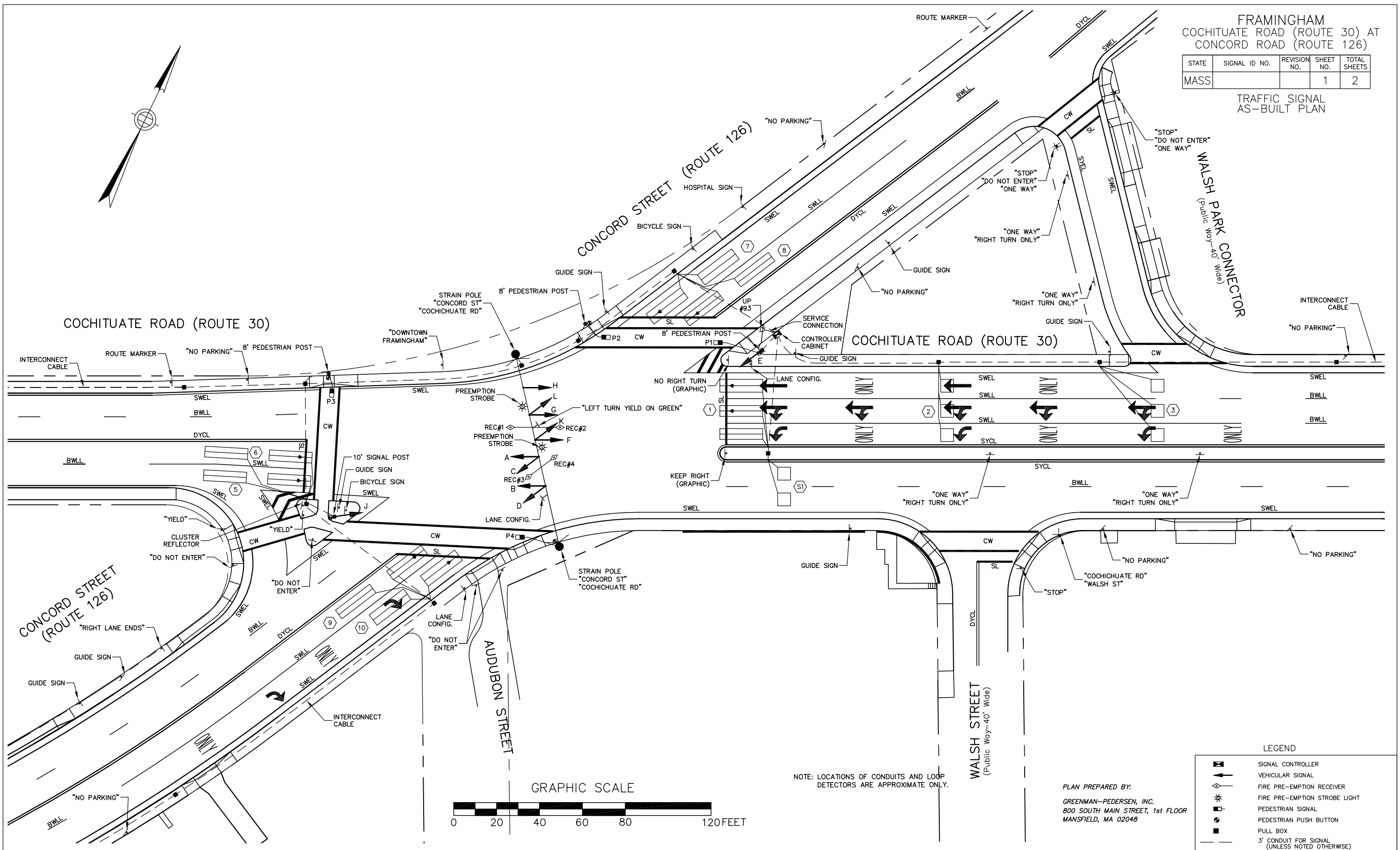
UTILITY POLE No. 57  
METER No. 96 813 302

PLAN PREPARED BY:  
GREENMAN-PEDERSEN, INC.  
800 SOUTH MAIN STREET, 1st FLOOR  
MANSFIELD, MA 02048

FRAMINGHAM  
COCHITUATE ROAD (ROUTE 30) AT  
CONCORD ROAD (ROUTE 126)

STATE	SIGNAL ID NO.	REVISION NO.	SHEET NO.	TOTAL SHEETS
MASS			1	2

TRAFFIC SIGNAL  
AS-BUILT PLAN



NOTE: LOCATIONS OF CONDUITS AND LOOP DETECTORS ARE APPROXIMATE ONLY.

PLAN PREPARED BY:  
GREENMAN-PEDERSEN, INC.  
800 SOUTH MAIN STREET, 1st FLOOR  
MANSFIELD, MA 02048

LEGEND

	SIGNAL CONTROLLER
	VEHICULAR SIGNAL
	FIRE PRE-EMPTION RECEIVER
	FIRE PRE-EMPTION STROBE LIGHT
	PEDESTRIAN SIGNAL
	PEDESTRIAN PUSH BUTTON
	PULL BOX
	3' CONDUIT FOR SIGNAL (UNLESS NOTED OTHERWISE)

LOCATION NO. 5  
COCHITUATE ROAD (ROUTE 30) @ CONCORD ROAD (ROUTE 126)  
(LOCAL)

FRAMINGHAM  
COCHITUATE ROAD (ROUTE 30) AT  
CONCORD ROAD (ROUTE 126)

STATE	SIGNAL ID NO.	REVISION NO.	SHEET NO.	TOTAL SHEETS
MASS			2	2

TRAFFIC SIGNAL DATA

FULLY-ACTUATED <input checked="" type="checkbox"/>	ISOLATED <input type="checkbox"/>							
SEMI-ACTUATED <input type="checkbox"/>	COORDINATED <input checked="" type="checkbox"/>							
PRE-TIMED <input type="checkbox"/>	WIRE <input checked="" type="checkbox"/>	TBCU <input type="checkbox"/>						

SEQUENCE AND TIMING

STREET	DIRECTION	HOUSINGS	1	2	3	4	5	6	7	8	9	10	11	12	13	14	15	13	14	15	FLASH OPER.	
COCHITUATE RD (RTE 30)	EB	A	G/GLY/YL	R	R	R	R	R	R	R	R	R	R	R	R	R	R	R	R	R	R	FR
COCHITUATE RD (RTE 30)	EB	B	GV	Y	R	R	R	R	R	R	R	R	R	R	R	R	R	R	R	R	R	FR
CONCORD RD (RTE 126)	NB	C	R	R	R	R	R	R	R	R	R	R	R	R	R	R	R	R	R	R	R	FY
CONCORD RD (RTE 126)	NB	D,E	R	R	R	R	R	R	R	R/GRR/YR	R	R	R	R	R	R	R	R	R	R	R	FY
COCHITUATE RD (RTE 30)	WB	F	R	R	R	R	R	R	R	GL	YL	RL	R	R	R	R	R	R	R	R	R	FRL
COCHITUATE RD (RTE 30)	WB	G,J	R	R	R	R	R	R	R	G/GLY/YL	R	R	R	R	R	R	R	R	R	R	R	FR
COCHITUATE RD (RTE 30)	WB	H	R	R	R	R	R	R	R	GV	Y	R	R	R	R	R	R	R	R	R	R	FR
CONCORD RD (RTE 126)	SB	K	R	R	R	G	Y	R	R	R	R	G/GLY/YL	R	R	R	R	R	R	R	R	R	FY
CONCORD RD (RTE 126)	SB	L	R	R	R	G	Y	R	R	R	R	G	Y	R	R	R	R	R	R	R	R	FY
PEDESTRIAN	-	P1-P2	DW	DW	DW	DW	DW	DW	DW	W	FDW	DW	DW	DW	DW	DW	DW	DW	DW	DW	DW	OUT
PEDESTRIAN	-	P3-P4	DW	DW	DW	DW	DW	DW	DW	DW	DW	DW	DW	DW	DW	DW	DW	W	FDW	DW	DW	OUT

EMERGENCY VEHICLE PRE-EMPTION

DIRECTION	PHASE CALL
EB - REC#1	ø2
WB - REC#2	ø6
NB - REC#3	ø8
SB - REC#4	ø4 & ø7

COORDINATION DATA FOR INTERSECTION 5  
ROUTE 30 (SUB-SYSTEM)

FUNCTION	PURPOSE	OFFSET VALUE IN SECONDS	CYCLE LENGTH
OFFSET 1	COORDINATED PATTERN NO. 1	78	80
OFFSET 2	COORDINATED PATTERN NO. 2	54	110
OFFSET 3	COORDINATED PATTERN NO. 3	68	110

COORD POINT SHALL BE AT THE START OF THE YELLOW OF THE FIRST PHASE, SHOWN BY \* BELOW.

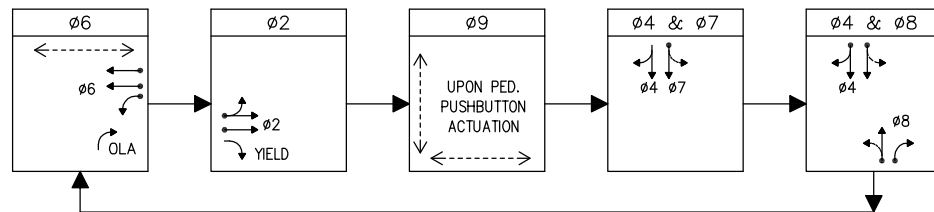
MAXIMUM PHASE TIME IN SECONDS

FUNCTION	PHASE 2 *	PHASE 4	PHASE 6 *	PHASE 7	PHASE 8	PHASE 9
SPLIT 1	12	28	14	14	14	26
SPLIT 2	18	38	27	14	24	27
SPLIT 3	18	38	27	14	24	27

	TIMING IN SECONDS																						
MINIMUM INITIAL	6			6			6			6			6										
PASSAGE	2			2			2			2			2										
MAXIMUM 1	30			47			40			15			25										
MAXIMUM 2	*			*			*			*			*										
CHANGE		4.5	1.0		4.5	3.0		4.5	3.0		5.0	2.0		5.0	2.0								
PEDESTRIAN							5	16	2								5	19	2				
RECALL		OFF			OFF			SOFT			OFF			OFF			OFF						
MEMORY		NON-LOCKING			NON-LOCKING			NON-LOCKING			NON-LOCKING			NON-LOCKING			LOCKING						

\* SEE COORDINATION DATA TABLE FOR SPLITS

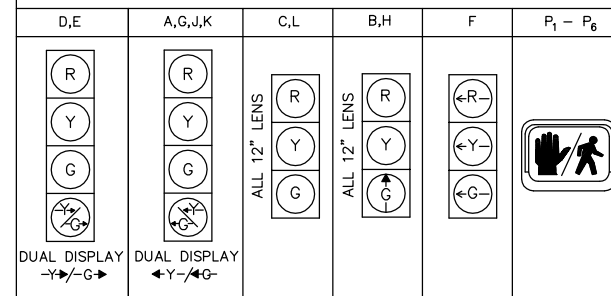
PREFERENTIAL PHASE SEQUENCE



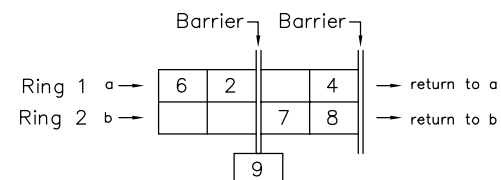
LOOP DETECTOR DATA

DETECTOR NO.	NO. OF SEGMENTS	LOOP SIZE	ø CALLED	ø EXT.	MODE A=PULSE B=PRES.	DELAY TIME	EXT. TIME
1	3	QUADRUPOLE	6	6	B	0	0
2	3	6'x6'	6	6	A	0	2
3	3	6'x6'	6	6	A	0	2
4	3	6'x6'	6	6	B	0	0
5	2	QUADRUPOLE	2	2	B	0	0
6	2	QUADRUPOLE	2	2	B	0	0
7	2	QUADRUPOLE	4	4	B	0	0
8	2	QUADRUPOLE	7	7	B	0	0
9	2	QUADRUPOLE	8	8	B	0	0
10	2	QUADRUPOLE	8	8	B	0	0
S1	2	6'x6'	SYSTEM		A	0	0

SIGNAL IDENTIFICATIONS



RING STRUCTURE



MAJOR ITEMS

QUANTITY	DESCRIPTION
1	CONTROLLER & CAB. TYPE 8DW W/FDN. MODEL: EAGLE EPAC 300
1	SERVICE CONNECTION
2	STRAIN POLE W/SPAN WIRE ASSEMBLY
1	10' SIGNAL POST, BASE, & FDN.
3	8' PEDESTRIAN POST, BASE, & FDN.
5	SIGNAL HEAD, 3 SECTION
6	SIGNAL HEAD, 4 SECTION
6	PEDESTRIAN HOUSING, PUSH BUTTON, SIGN & SADDLE
23	ROADWAY LOOP DETECTOR (INCLUDES SYSTEM DETECTORS)
5	DUAL CHANNEL LOOP DETECTOR AMPLIFIER
12	PULL BOX 12" x 12"
1	OPTICOM SYSTEM CHASSIS
2	OPTICOM DUAL CHANNEL PHASE SELECTOR
1	OPTICOM PREEMPTION CONFIRMATION
4	OPTICOM UNIDIRECTIONAL SINGLE OPTICAL DETECTOR

PLUS ALL MISCELLANEOUS EQUIPMENT AND MATERIAL NECESSARY TO PROVIDE A COMPLETE OPERATING TRAFFIC CONTROL SIGNAL.

UTILITY POLE No. 93  
METER No. 36 622 300

PLAN PREPARED BY:  
GREENMAN-PEDERSEN, INC.  
800 SOUTH MAIN STREET, 1st FLOOR  
MANSFIELD, MA 02048



# **Appendix C: Crash Rates Worksheets and Collision Diagrams**



















# COLLISION DIAGRAM

CITY/TOWN: Framingham

DATE PREPARED: 4/08/2013

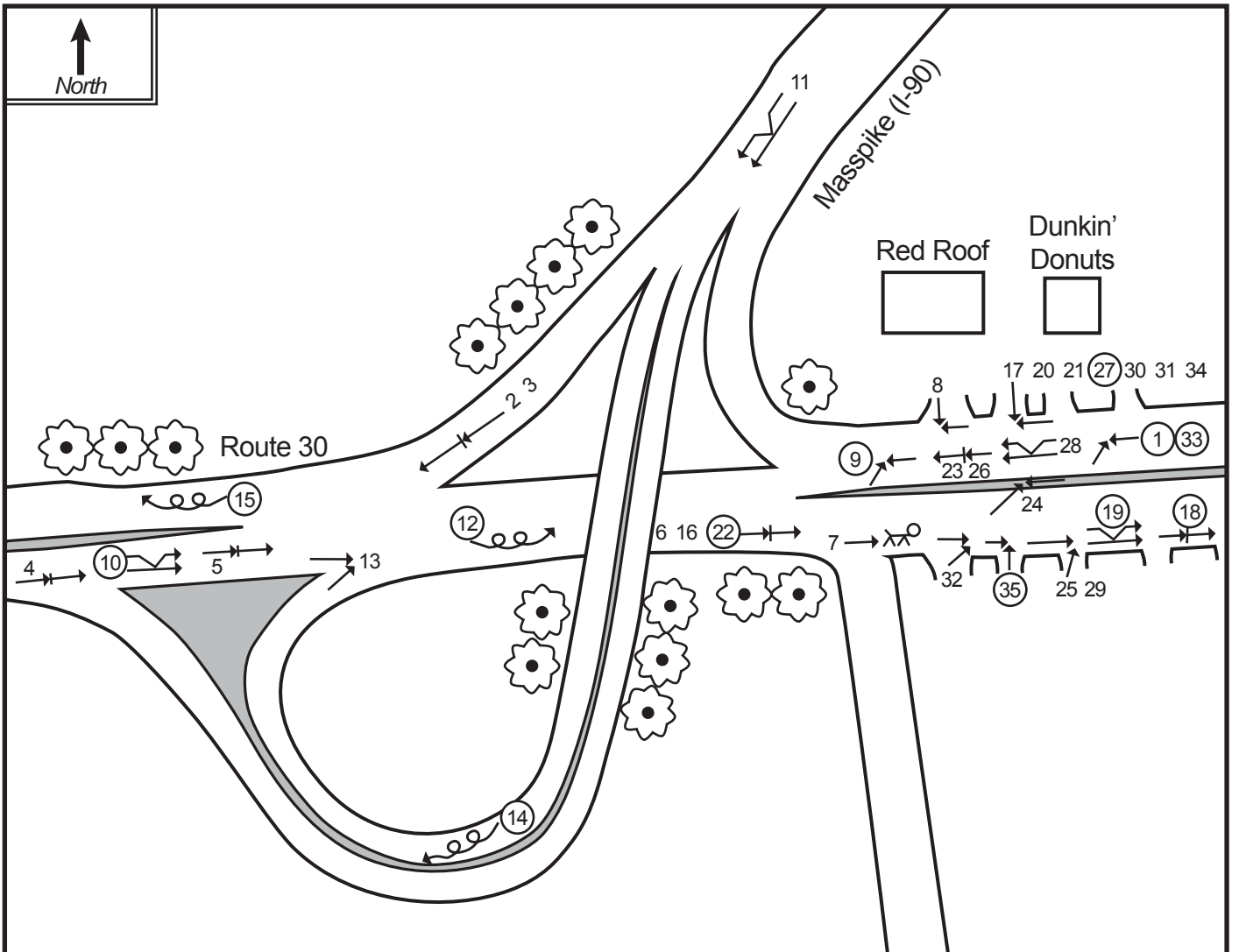
REGION: District 3

















PREPARED BY: Ryan Hicks


ROADWAY NAMES: Route 30 between Masspike Ramps to Speen Street

TIME PERIOD ANALYZED: 2007-2012

SOURCE OF CRASH REPORTS: \_\_\_\_\_



SYMBOLS	TYPES OF CRASH	SEVERITY
<ul style="list-style-type: none"> <li> Moving Vehicle</li> <li> Backing Vehicle</li> <li> Non-Involved Vehicle</li> <li> Pedestrian</li> <li> Parked Vehicle</li> <li> Fixed Object</li> <li> Bicycle</li> <li> Animal</li> </ul>	<ul style="list-style-type: none"> <li> Head On</li> <li> Angle</li> <li> Turning Move</li> <li> Rear End</li> <li> Sideswipe</li> <li> Out of Control</li> </ul>	<ul style="list-style-type: none"> <li> Injury Accident</li> <li> Fatal Accident</li> </ul>



# COLLISION DIAGRAM

CITY/TOWN : Framingham

DATE PREPARED : 4/08/2013

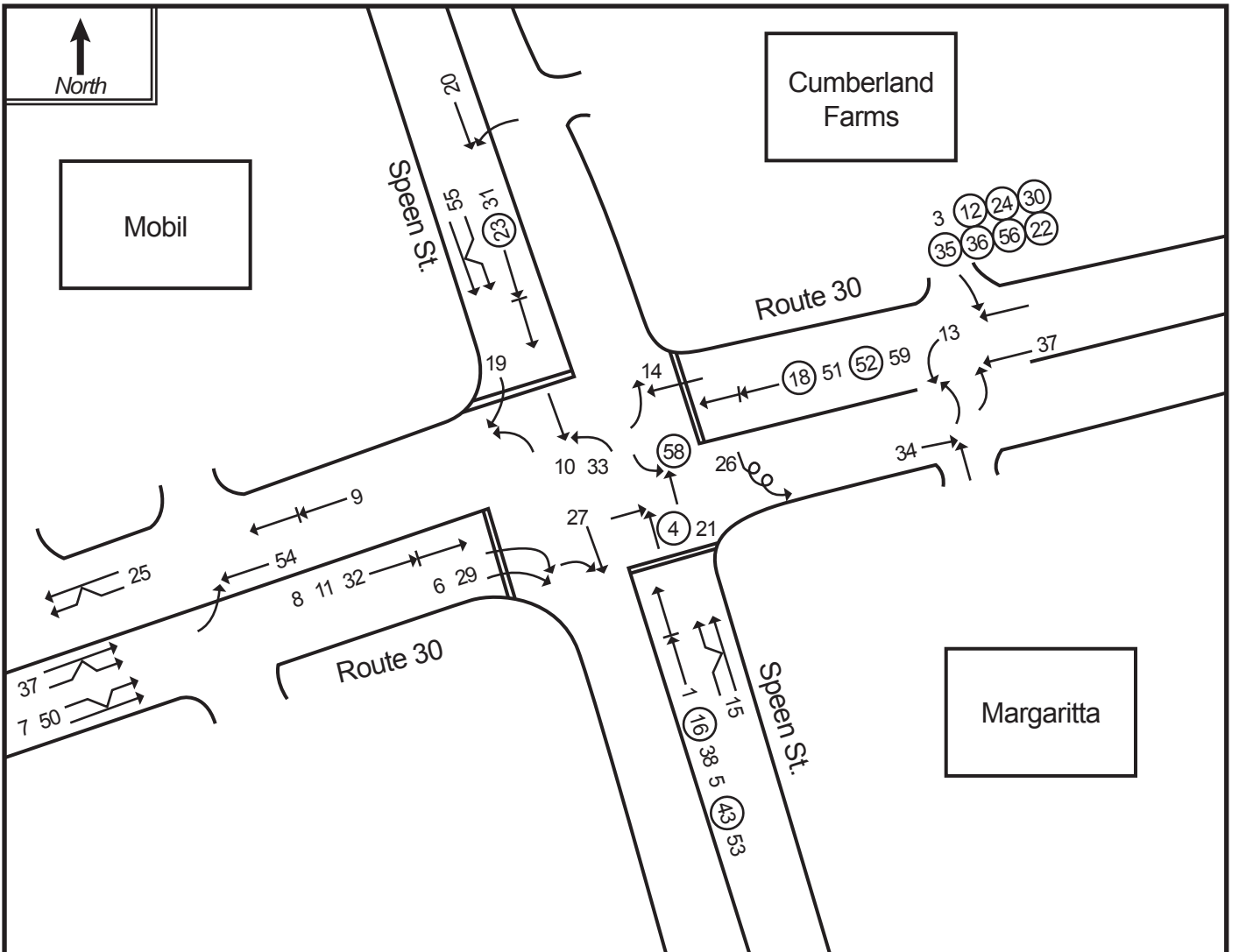
REGION : District 3

















PREPARED BY : Ryan Hicks

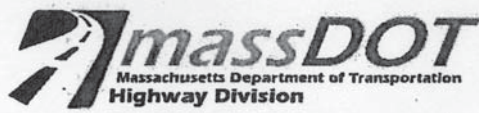
ROADWAY NAMES : Route 30

TIME PERIOD ANALYZED : 2007-2013

SOURCE OF CRASH REPORTS : Town of Framingham and MassDOT RMV



SYMBOLS	TYPES OF CRASH	SEVERITY
<ul style="list-style-type: none"> <li> Moving Vehicle</li> <li> Backing Vehicle</li> <li> Non-Involved Vehicle</li> <li> Pedestrian</li> <li> Parked Vehicle</li> <li> Fixed Object</li> <li> Bicycle</li> <li> Animal</li> </ul>	<ul style="list-style-type: none"> <li> Head On</li> <li> Angle</li> <li> Turning Move</li> <li> Rear End</li> <li> Sideswipe</li> <li> Out of Control</li> </ul>	<ul style="list-style-type: none"> <li> Injury Accident</li> <li> Fatal Accident</li> </ul>



# COLLISION DIAGRAM

CITY/TOWN : Framingham

DATE PREPARED : 4/05/2013

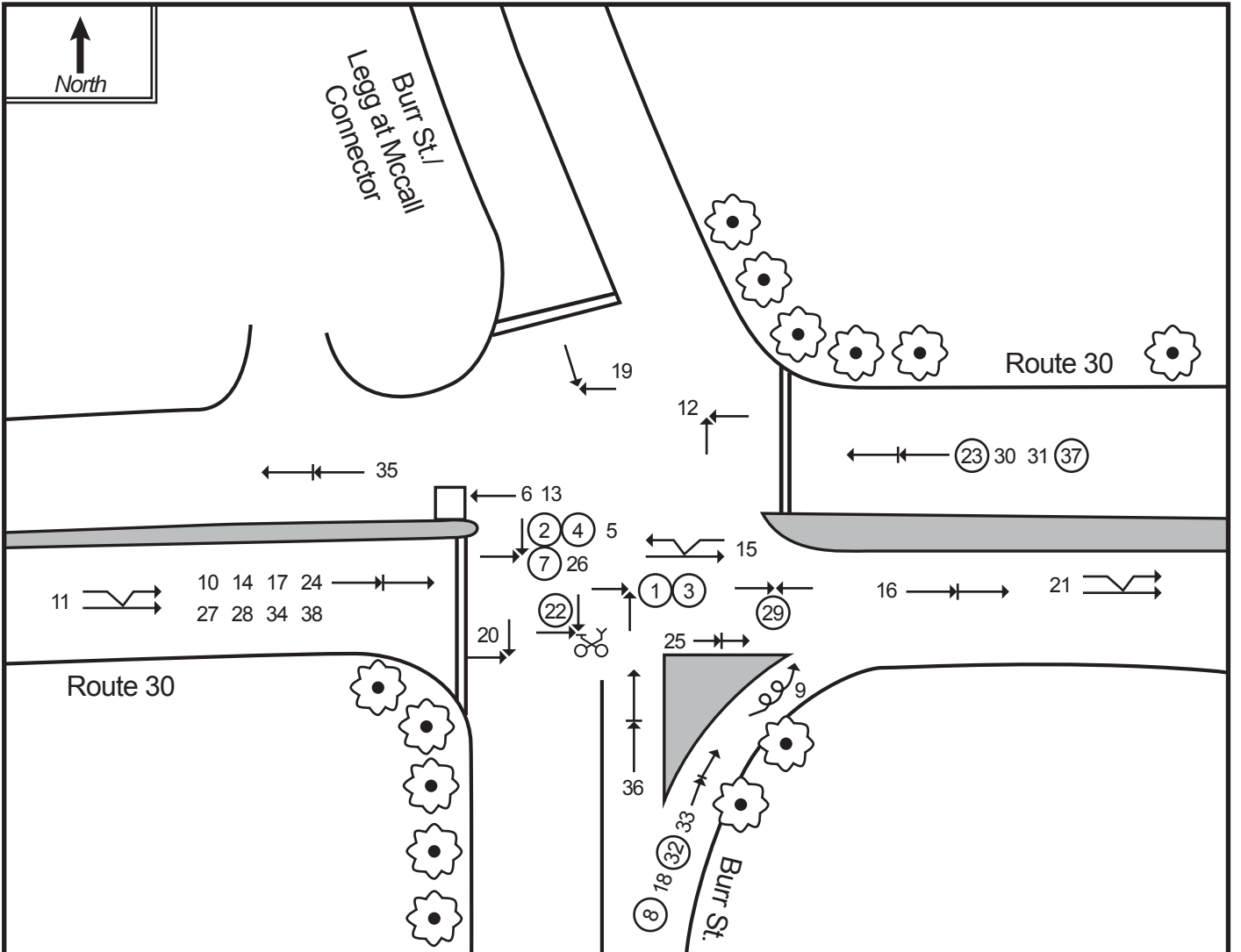
REGION : District 3

















PREPARED BY : Ryan Hicks


ROADWAY NAMES : Burr Street and Route 30

TIME PERIOD ANALYZED : 2007-2012

SOURCE OF CRASH REPORTS : Town of Framingham and MassDOT RMV



SYMBOLS	TYPES OF CRASH	SEVERITY
<ul style="list-style-type: none"> <li> Moving Vehicle</li> <li> Backing Vehicle</li> <li> Non-Involved Vehicle</li> <li> Pedestrian</li> <li> Parked Vehicle</li> <li> Fixed Object</li> <li> Bicycle</li> <li> Animal</li> </ul>	<ul style="list-style-type: none"> <li> Head On</li> <li> Angle</li> <li> Turning Move</li> <li> Rear End</li> <li> Sideswipe</li> <li> Out of Control</li> </ul>	<ul style="list-style-type: none"> <li> Injury Accident</li> <li> Fatal Accident</li> </ul>



**massDOT**  
Massachusetts Department of Transportation  
Highway Division

## COLLISION DIAGRAM

CITY/TOWN : Framingham

DATE PREPARED : 4/05/2013

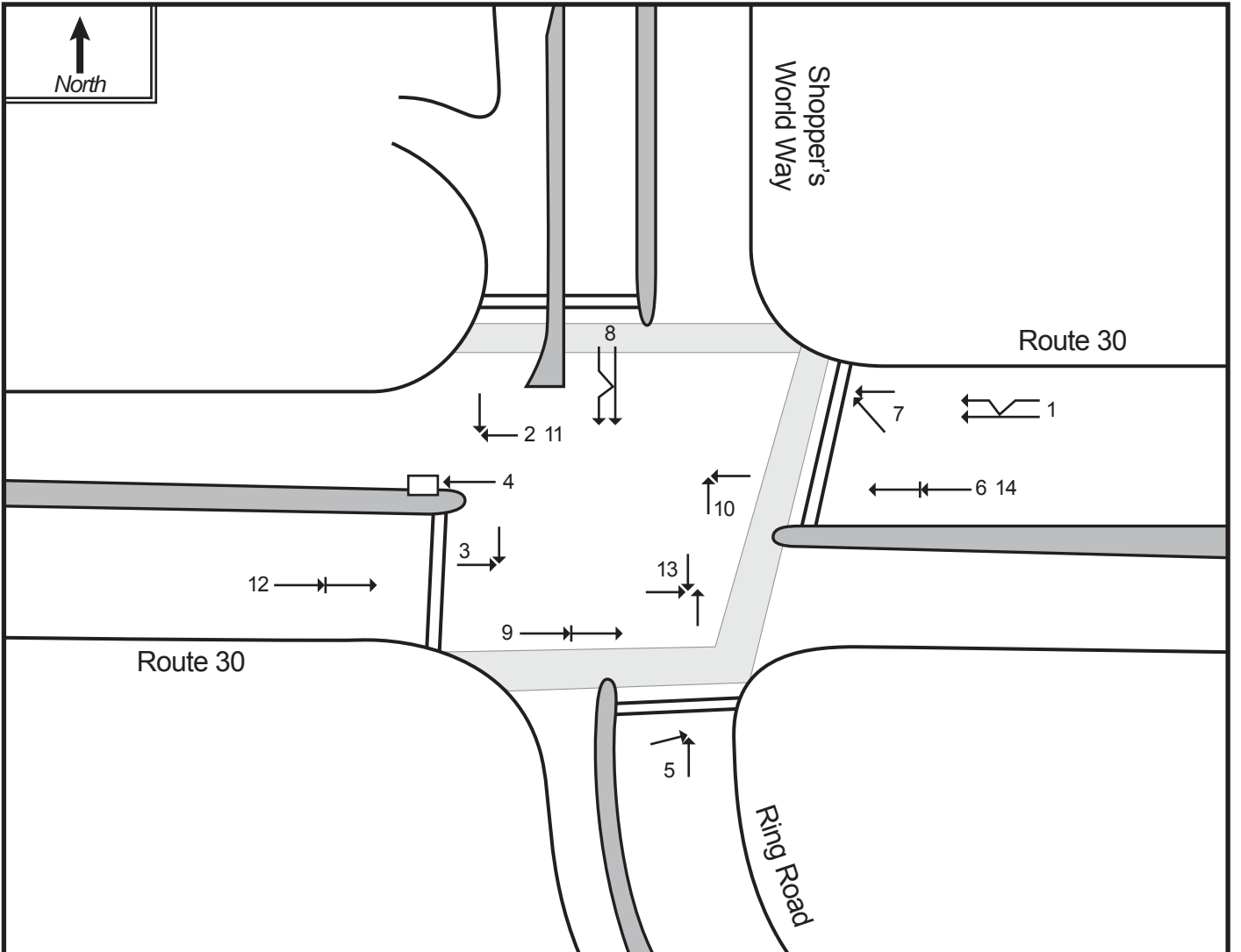
REGION : District 3

















PREPARED BY : Ryan Hicks

ROADWAY NAMES : Route 30/Cochituate Road and Ring Road/ Shoppers World Way

TIME PERIOD ANALYZED : 2006-2011

SOURCE OF CRASH REPORTS : Town of Framingham and MassDOT RMV



SYMBOLS	TYPES OF CRASH	SEVERITY
<ul style="list-style-type: none"> <li> Moving Vehicle</li> <li> Backing Vehicle</li> <li> Non-Involved Vehicle</li> <li> Pedestrian</li> <li> Parked Vehicle</li> <li> Fixed Object</li> <li> Bicycle</li> <li> Animal</li> </ul>	<ul style="list-style-type: none"> <li> Head On</li> <li> Angle</li> <li> Turning Move</li> <li> Rear End</li> <li> Sideswipe</li> <li> Out of Control</li> </ul>	<ul style="list-style-type: none"> <li> Injury Accident</li> <li> Fatal Accident</li> </ul>



Route 30 at Speen Street

Collision Diagram ID	Crash Number	Crash Date	Crash Time	Crash Severity	Manner of Collision	Road Surface	Ambient Lighting	Weather Condition	Non motorized	Bike Ped
1	9100000	29-Jun-2011	6:43:00 PM	Property damage only (nc	Rear-end		Daylight	Clear/Clear		
2	9100001	31-Jul-2007	2:20:00 PM							
3	2331794	04-Jun-2008	3:03:00 PM	Non-fatal injury	Angle	Dry	Daylight	Clear		
4	2287898	08-Feb-2008	4:49:00 PM	Non-fatal injury	Angle	Wet	Dusk	Clear		
5	2337043	14-Jun-2008	1:07:00 PM	Property damage only (nc	Rear-end	Dry	Daylight	Clear		
6	2337059	18-Jun-2008	9:22:00 AM	Property damage only (nc	Angle	Dry	Daylight	Clear		
7	2342440	03-Jul-2008	1:00:00 PM	Property damage only (nc	Sideswipe, same dir	Dry	Daylight	Clear/Clear		
8	2345119	09-Jul-2008	5:20:00 PM	Property damage only (nc	Rear-end	Dry	Daylight	Clear		
9	9100002	7-Aug-2008	4:50:00 PM	Property damage only (nc	Rear-end	Wet	Daylight	Wet		
10	2375331	12-Sep-2008	11:40:00 AM	Property damage only (nc	Angle	Dry	Daylight	Clear		
11	2269130	14-Jan-2008	8:00:00 PM	Property damage only (nc	Rear-end	Dry	Dark - lighted r	Clear		
12	2575112	08-Mar-2010	4:17:00 PM	Non-fatal injury	Sideswipe, opposite	Dry	Daylight	Clear		
13	2588874	21-Apr-2010	2:29:00 PM	Property damage only (nc	Angle	Dry	Daylight	Clear		
14	2674268	26-Nov-2010	5:59:00 PM	Property damage only (nc	Angle	Dry	Unknown	Clear/Clear		
15	2581544	23-Mar-2010	9:41:00 AM	Property damage only (nc	Sideswipe, same dir	Dry	Daylight	Rain/Rain		
16	2600508	23-May-2010	1:45:00 PM	Non-fatal injury	Rear-end	Dry	Daylight	Clear/Clear		
17	2643847	04-Sep-2010	5:24:00 PM	Property damage only (nc	Angle	Dry	Daylight	Clear		
18	2631484	18-Aug-2010	2:10:00 PM	Non-fatal injury	Rear-end	Dry	Daylight	Clear		
19	2675755	26-Dec-2010	4:49:00 PM	Property damage only (nc	Angle	Dry	Daylight	Clear/Clear		
20	9100003	11-May-2011	7:15:00 AM	Property damage only (nc	Angle	Wet	Daylight	Wet		
21	9100004	31-Mar-2011	11:50:00 PM	Property damage only (nc	Angle	Snow	Dark - lighted r	Snow		
22	9100005	29-Mar-2011	4:25:00 PM	Non-fatal injury	Angle		Daylight	Clear		
23	9100006	22-Mar-2011	5:24:00 PM	Non-fatal injury	Rear-end		Daylight	Clear		
24	9100007	6-Jan-2011	5:13:00 PM	Non-fatal injury	Angle		Dark - lighted r	Clear		
25	9100008	3-Dec-2011	11:40:00 PM	Property damage only (nc	Sideswipe		Dark - lighted r	Clear		
26	9100009	1-Mar-2011	1:05:00 AM	Property damage only (nc	Single vehicle crash		Dark - lighted r	Clear		
27	9100010	18-Mar-2011	2:39:00 PM	Property damage only (nc	Sideswipe		Daylight	Clear		
28	9100011	4-Aug-2011	2:25:00 PM				Daylight	Clear		
29	9100012	23-Dec-2011	1:31:00 PM	Property damage only (nc	Sideswipe		Daylight	Clear		
30	9100013	22-Mar-2012	12:16:00 PM	Non-fatal injury	Angle		Daylight	Clear		
31	9100014	31-Aug-2011	8:09:00 AM	Property damage only (nc	Rear-end		Daylight	Clear		
32	9100015	31-Oct-2012	10:15:00 AM	Property damage only (nc	Rear-end		Daylight	Clear		

Route 30 at Speen Street

Collision Diagram ID	Crash Number	Crash Date	Crash Time	Crash Severity	Manner of Collision	Road Surface	Ambient Lighting	Weather Condition	Non motorized	Bike Ped
33	9100016	8-May-2012	7:00:00 AM	Property damage only (nc	Angle	Wet	Daylight	Wet		
34	9100017	1-Jun-2012	4:23:00 PM	Property damage only (nc	Angle		Daylight	Clear		
35	9100018	7-Jul-2012	4:29:00 PM	Non-fatal injury	Angle		Daylight	Clear		
36	9100019	28-Apr-2012	1:42:00 PM	Non-fatal injury	Angle		Daylight	Clear		
37	9100020	28-Nov-2012	5:25:00 PM	Property damage only (nc	Angle		Dark - lighted r	clear		
38	9100021	18-Aug-2010	8:51:00 AM	Property damage only (nc	Rear-end					
40	2189770	08-May-2007	5:30:00 PM	Property damage only (nc	Angle	Dry	Daylight	Clear		
41	2228484	21-Aug-2007	1:20:00 PM	Property damage only (nc	Rear-end	Dry	Daylight	Clear		
42	2392240	26-Dec-2007	2:55:00 AM	Non-fatal injury	Rear-end	Dry	Daylight	Clear		
43	2487461	06-Jul-2009	4:41:00 PM	Non-fatal injury	Rear-end	Dry	Daylight	Clear		
44	2220583	20-Jul-2007	7:40:00 PM	Property damage only (nc	Rear-end	Dry	Daylight	Clear		
45	2222468	13-Jul-2007	3:46:00 PM	Non-fatal injury	Angle	Dry	Daylight	Clear		
46	2220979	31-Jul-2007	8:53:00 AM	Property damage only (nc	Angle	Dry	Daylight	Clear		
47	2236921	03-Oct-2007	2:25:00 PM	Property damage only (nc	Rear-end	Dry	Daylight	Clear/Cloudy		
48	2250851	11-Jun-2007	10:11:00 AM	Property damage only (nc	Sideswipe, same dir	Dry	Daylight	Clear		
49	2373444	29-Jun-2007	4:18:00 PM	Property damage only (nc	Rear-end	Dry	Daylight	Clear		
50	2401522	02-Dec-2008	10:30:00 AM	Property damage only (nc	Sideswipe, same dir	Wet	Daylight	Clear/Clear		
51	2446568	24-Mar-2009	3:24:00 PM	Property damage only (nc	Rear-end	Dry	Daylight	Clear		
52	2450305	06-Apr-2009	7:59:00 PM	Non-fatal injury	Rear-end	Wet	Dark - lighted r	Cloudy/Rain		
53	2461910	04-May-2009	9:00:00 AM	Property damage only (nc	Rear-end	Dry	Daylight	Cloudy		
54	2467822	16-May-2009	1:43:00 PM	Property damage only (nc	Angle	Dry	Daylight	Clear		
55	2468393	13-May-2009	5:00:00 PM	Property damage only (nc	Sideswipe, same dir	Dry	Daylight	Clear		
56	2476889	04-Jun-2009	11:10:00 AM	Non-fatal injury	Angle	Dry	Daylight	Clear		
57	2476890	04-Jun-2009	1:29:00 PM	Property damage only (nc	Angle	Dry	Daylight	Clear		
58	2478353	03-Jun-2009	2:30:00 PM	Non-fatal injury	Angle	Dry	Daylight	Clear/Clear		
59	2482390	22-Jun-2009	2:30:00 PM	Not Reported	Rear-end	Wet	Daylight	Rain/Cloudy		
60	2171478	28-Mar-2007	10:57:00 AM	Property damage only (nc	Angle	Dry	Daylight	Clear/Clear		
	2353348	19-Jul-2007	5:30:00 PM	Property damage only (nc	Angle	Wet	Daylight	Rain		
	2252475	26-Nov-2007	12:47:00 PM	Non-fatal injury	Angle	Wet	Daylight	Rain		
	2169653	23-Feb-2007	3:16:00 PM	Property damage only (nc	Rear-end	Dry	Daylight	Clear		
	2313108	04-Apr-2007	5:00:00 PM	Property damage only (nc	Not reported	Ice	Dusk	Snow/Sleet,		
	2350248	17-Aug-2007	11:45:00 AM	Property damage only (nc	Sideswipe, same dir	Dry	Daylight	Cloudy		

Route 30 at Speen Street

Collision Diagram ID	Crash Number	Crash Date	Crash Time	Crash Severity	Manner of Collision	Road Surface	Ambient Lighting	Weather Condition	Non motorized	Bike Ped
	2346219	10-Sep-2007	6:00:00 PM	Property damage only (nc	Rear-end	Dry	Dusk	Clear		
	2370446	19-Oct-2007	1:05:00 AM	Property damage only (nc	Rear-end	Wet	Dark - lighted r	Rain/Cloudy		
	2272188	27-Feb-2007	11:25:00 AM	Property damage only (nc	Not reported	Dry	Daylight	Clear		
	2455603	13-Jan-2008	9:05:00 AM	Property damage only (nc	Angle	Wet	Daylight	Rain		
	2482965	22-Feb-2008	4:00:00 AM	Not Reported	Rear-end	Snow	Daylight	Snow		
	2512687	27-Mar-2008	12:50:00 PM	Property damage only (nc	Rear-end	Dry	Daylight	Clear		
	2516600	19-Jun-2008	9:20:00 AM	Property damage only (nc	Angle	Dry	Dark - lighted r	Clear		
	2464666	31-Jul-2008	2:20:00 AM	Property damage only (nc	Not reported	Dry	Daylight	Cloudy		
	2365837	23-Aug-2008	1:20:00 AM	Property damage only (nc	Rear-end	Dry	Daylight	Clear		
	2480684	27-Dec-2008	9:30:00 AM	Property damage only (nc	Rear-end	Dry	Dark - lighted r	Clear		
	2415597	29-Apr-2008	5:45:00 PM	Property damage only (nc	Rear-end	Wet	Daylight	Rain		
	2542697	03-Dec-2009	12:48:00 PM	Property damage only (nc	Rear-end	Dry	Daylight	Clear		
	2503361	08-Aug-2009	10:55:00 PM	Non-fatal injury	Head-on	Dry	Dark - lighted r	Clear		
	2503364	14-Aug-2009	6:24:00 PM	Non-fatal injury	Head-on	Dry	Daylight	Clear		
	2605177	14-Aug-2009	6:24:00 PM	Non-fatal injury	Angle	Dry	Daylight	Clear		
	2530665	10-Sep-2009	4:54:00 PM	Property damage only (nc	Angle	Dry	Daylight	Clear	P1:Pedalcycli	cyc
	2608285	22-Sep-2009	8:55:00 AM	Not Reported	Rear-end	Dry	Daylight	Clear		
	2523667	30-Sep-2009	9:08:00 AM	Non-fatal injury	Rear-end	Dry	Daylight	Clear		
	2532719	04-Nov-2009	7:18:00 PM	Property damage only (nc	Rear-end	Dry	Dark - lighted r	Clear		
	2542015	27-Nov-2009	1:46:00 PM	Property damage only (nc	Rear-end	Wet	Daylight	Rain		
	2614130	27-Jun-2010	1:03:00 AM	Property damage only (nc	Sideswipe, same dir	Dry	Daylight	Clear		

Route 30 between Burr Street and Speen Street

Collision Diagram ID	Crash Number	Crash Date	Crash Time	Crash Severity	Manner of Collision	Road Surface	Ambient Light	Weather Condition	Non motorized	Bike Ped
1	8000035	4-Jan-2010	8:05:00 PM	Non-fatal injury	Angle	Wet	Dark - lighted r	Clear		
2	8000032	3-May-2012	9:06:00 AM	Property damage only (n	Rear-end	Wet	Daylight	Cloudy		
3	8000031	26-Apr-2012	8:56:00 AM	Property damage only (n	Rear-end	Dry	Daylight	Clear		
4	8000030	17-Feb-2012	1:53:00 PM	Property damage only (n	Rear-end	Dry	Daylight	Clear		
5	8000029	27-Apr-2012	9:30:00 AM	Property damage only (n	Rear-end	Dry	Daylight	Clear		
6	8000028	20-May-2011	4:30:00 PM	Property damage only (n	Rear-end	Dry	Daylight	Clear		
7	8000027	27-Apr-2011	1:10:00 PM	Property damage only (n	Single Vehicle c	Dry	Daylight	Clear		
8	8000026	30-Oct-2011	3:53:00 PM	Property damage only (n	Angle	Dry	Daylight	Clear		
9	8000025	22-May-2011	3:35:00 PM	Non-fatal injury	Angle	Dry	Daylight	Cloudy		
10	8000024	25-Nov-2011	5:20:00 PM	Non-fatal injury	Sideswipe, sam	Dry	Dark - lighted r	Clear		
11	8000023	22-Dec-2010	3:00:00 PM	Property damage only (n	Sideswipe, sam	Dry	Daylight	Clear		
12	2633717	26-Aug-2010	6:05:00 PM	Non-fatal injury	Single vehicle c	Other	Daylight	Clear		
13	2561603	29-Jan-2010	9:17:00 PM	Property damage only (n	Angle	Dry	Dark - lighted r	Clear		
14	2327813	02-Jun-2008	2:32:00 PM	Non-fatal injury	Single vehicle c	Dry	Daylight	Clear		
15	8000022	23-Jun-2012	4:00:00 PM	Non-fatal injury	Single Vehicle c	Dry	Daylight	Clear		
16	8000021	11-May-2012	12:38:00 PM	Property damage only (n	Rear-end	Dry	Daylight	Cloudy		
17	8000020	10-Sep-2012	12:00:00 AM	Property damage only (n	Angle	Dry	Dark - lighted r	Clear		
18	8000019	24-May-2011	5:51:00 PM	Non-fatal injury	Rear-end	Dry	Daylight	Cloudy		
19	8000018	20-May-2011	8:24:00 AM	Non-fatal injury	Sideswipe, sam	Wet	Daylight	Rain		
20	8000017	15-Mar-2011	5:28:00 PM	Property damage only (n	Angle	Dry	Daylight	Clear		
21	8000016	20-Jan-2011	3:50:00 PM	Property damage only (n	Angle	Dry	Daylight	Clear		
22	8000015	2-Apr-2011	1:07:00 PM	Non-fatal injury	Rear-end	Dry	Daylight	Clear		
23	8000014	14-Oct-2011	5:23:00 PM	Property damage only (n	Rear-end	Wet	Daylight	Rain		
24	8000013	2-Feb-2010	3:29:00 PM	Property damage only (n	Angle	Dry	Daylight	Clear		
25	8000012	24-Mar-2010	2:00:00 PM	Property damage only (n	Angle	Dry	Daylight	Clear		
26	8000011	1-Sep-2010	8:08:00 AM	Property damage only (n	Rear-end	Dry	Daylight	Clear		
27	8000010	5-Aug-2010	5:05:00 PM	Non-fatal injury	Angle	Wet	Daylight	Rain		
28	8000009	20-Mar-2010	8:05:00 AM	Property damage only (n	Sideswipe, sam	Dry	Daylight	Clear		
29	8000008	19-Feb-2010	3:56:00 PM	Property damage only (n	Angle	Dry	Daylight	Clear		
30	8000007	10-Dec-2008	5:35:00 PM	Property damage only (n	Angle	Wet	Dark - lighted r	Rain		
31	8000006	18-Sep-2008	5:51:00 PM	Property damage only (n	Angle	Dry	Daylight	Clear		
32	8000005	11-Jun-2008	6:15:00 PM	Property damage only (n	Angle	Dry	Daylight	Clear		

Route 30 between Burr Street and Speen Street

Collision Diagram ID	Crash Number	Crash Date	Crash Time	Crash Severity	Manner of Collision	Road Surface	Ambient Light	Weather Condition	Non motorized	Bike Ped
33	8000004	5-Apr-2008	10:26:00 AM	Non-fatal injury	Angle	Wet	Daylight	Rain		
34	8000002	28-Feb-2008	5:10:00 PM	Property damage only (n	Angle	Dry	Daylight	Clear		
35	8000001	2-Oct-2008	5:15:00 PM	Non-fatal injury	Angle	Dry	Daylight	Clear		
	8000003	19-Mar-2008	11:28:00 AM							
	8000033	9-Jul-2010	2:37:00 PM							
	8000034	8-Aug-2010	10:44:00 PM							
	2226960	09-Aug-2007	8:48:00 PM	Property damage only (n	Head-on	Dry	Dark - lighted r	Clear		
	2264472	28-Dec-2007	6:40:00 PM	Non-fatal injury	Rear-end	Dry	Dark - lighted r	Clear		
	2415374	10-Jan-2009	3:34:00 AM	Non-fatal injury	Angle	Dry	Dark - lighted r	Clear/Clear		



Route 30 @ Burr Street

Collision Diagram ID	Crash Number	Crash Date	Crash Time	Crash Severity	Manner of Collision	Road Surface	Ambient Light	Weather Condition	Non Motorized	Bike Ped
1	2341966	02-Jul-2008	9:36:00 PM	Non-fatal injury	Angle	Wet	Dark - lighted r	Rain/Rain		
2	2408232	22-Dec-2008	2:17:00 PM	Non-fatal injury	Angle	Wet	Daylight	Clear		
3	2602770	22-May-2010	12:30:00 PM	Non-fatal injury	Angle	Dry	Daylight	Clear		
4	2630054	16-Aug-2010	12:11:00 PM	Non-fatal injury	Angle	Dry	Daylight	Cloudy		
5	2662831	18-Nov-2010	12:45:00 PM	Property damage only (none	Angle	Dry	Daylight	Clear		
6	2632598	24-Aug-2010	8:18:00 PM	Property damage only (none	Single vehicle crash	Wet	Dark - lighted r	Rain/Cloudy		
7	2653424	21-Oct-2010	11:21:00 AM	Non-fatal injury	Angle	Dry	Daylight	Cloudy		
8	2655261	20-Oct-2010	6:50:00 AM	Non-fatal injury	Rear-end	Dry	Dawn	Fog, smog		
9	2658609	08-Nov-2010	2:15:00 PM	Property damage only (none	Single vehicle crash	Wet	Daylight	Cloudy/Cloudy		
10	9000001	15-Oct-2011	6:45:00 PM	Property damage only (none	Rear-end	Dry	Dusk	Clear		
11	9000002	7-Feb-2011	3:55:00 PM	Property damage only (none	Sideswipe, same di	Dry	Daylight	Clear		
12	9000003	3-May-2011	9:00:00 PM	Property damage only (none	Angle	Dry	Dark - lighted r	Clear		
13	9000004	2-Sep-2011	10:48:00 PM	Property damage only (none	Single vehicle crash	Dry	Dark - lighted r	Clear		
14	9000005	13-Sep-2011	8:55:00 AM	Property damage only (none	Rear-end	Dry	Daylight	Clear		
15	9000006	26-Dec-2011	12:57:00 PM	Property damage only (none	Sideswipe, opposit	Dry	Daylight	Clear		
16	9000007	15-Jan-2011	2:23:00 PM	Property damage only (none	Rear-end	Dry	Daylight	Clear		
17	9000008	10-Dec-2012	5:20:00 PM	Property damage only (none	Rear-end	Wet	Dark - lighted r	Rain		
18	9000009	16-Apr-2012	8:17:00 AM	Non-fatal injury	Rear-end	Dry	Daylight	Clear		
19	9000010	18-Jan-2012	9:26:00 AM	Property damage only (none	Angle	Dry	Daylight	Clear		
20	9000011	2-Jul-2012	7:50:00 PM	Non-fatal injury	Angle	Dry	Daylight	Clear		
21	2568679	24-Feb-2010	10:32:00 PM	Property damage only (none	Sideswipe, same di	Wet	Dark - lighted r	Rain		
22	2597298	11-May-2010	7:20:00 PM	Non-fatal injury	Angle	Dry	Daylight	Cloudy	P4:Pedalcycl cyc	
23	2162901	11-Mar-2007	2:39:00 PM	Non-fatal injury	Rear-end	Dry	Daylight	Clear		
24	2162905	09-Mar-2007	5:37:00 PM	Property damage only (none	Rear-end	Dry	Daylight	Clear		
25	2471100	21-May-2009	5:08:00 PM	Property damage only (none	Rear-end	Dry	Daylight	Clear/Clear		
26	2227020	11-Aug-2007	3:17:00 PM	Property damage only (none	Angle	Dry	Daylight	Clear		
27	2228427	23-Aug-2007	6:00:00 PM	Property damage only (none	Rear-end	Dry	Daylight	Clear		
28	2247976	19-May-2007	8:25:00 AM	Property damage only (none	Rear-end	Wet	Daylight	Rain		
29	2275085	20-Dec-2007	1:23:00 PM	Non-fatal injury	Head-on	Wet	Daylight	Snow		
30	2299061	24-Mar-2008	8:03:00 AM	Property damage only (none	Rear-end	Dry	Daylight	Clear		
31	2399738	23-Nov-2008	12:00:00 AM	Non-fatal injury	Rear-end	Dry	Dark - lighted r	Clear		
32	2422556	27-Jan-2009	1:03:00 PM	Non-fatal injury	Rear-end	Dry	Daylight	Clear		
33	2437587	28-Feb-2009	3:07:00 PM	Property damage only (none	Rear-end	Dry	Daylight	Cloudy		
34	2379949	08-Oct-2008	4:54:00 PM	Property damage only (none	Rear-end	Dry	Daylight	Clear		
35	2493435	16-Jul-2009	10:57:00 AM	Property damage only (none	Rear-end	Wet	Daylight	Cloudy/Rain		
36	2502974	13-Aug-2009	4:33:00 PM	Property damage only (none	Rear-end	Wet	Daylight	Rain		
37	9000012	19-Apr-2012	2:43:00 PM	Non-fatal injury	Rear-end	Dry	Daylight	Clear		
38	2226048	03-Aug-2007	8:57:00 AM	Property damage only (none	Rear-end	Dry	Daylight	Clear		
	2357166	08-May-2007	2:00:00 AM	Non-fatal injury	Rear-end	Dry	Daylight	Clear		

Route 30 @ Burr Street

Collision Diagram ID	Crash Number	Crash Date	Crash Time	Crash Severity	Manner of Collision	Road Surface	Ambient Light	Weather Condition	Non Motorized	Bike Ped
	2383748	29-Sep-2007	4:30:00 PM	Property damage only (none)	Rear-end	Dry	Daylight	Clear		
	2260364	16-Nov-2007	3:18:00 PM	Property damage only (none)	Sideswipe, same di	Dry	Daylight	Clear		
	2262102	27-Dec-2007	1:34:00 PM	Property damage only (none)	Sideswipe, same di	Wet	Daylight	Rain		
	2467639	19-Oct-2008	3:30:00 PM	Property damage only (none)	Rear-end	Dry	Daylight	Clear		
	2496048	23-Jul-2009	8:26:00 AM	Property damage only (none)	Rear-end	Dry	Daylight	Clear		
	2517554	23-Sep-2009	7:37:00 AM	Property damage only (none)	Sideswipe, same di	Dry	Daylight	Clear/Clear		
	2549738	30-Dec-2009	6:50:00 AM	Non-fatal injury	Angle	Dry	Daylight	Clear		
	2744251	30-Sep-2010	11:30:00 AM	Non-fatal injury	Not reported	Wet	Daylight	Cloudy/Rain		

Route 30 at Whittier Street

Collision Diagram ID	Crash Number	Crash Date	Crash Time	Crash Severity	Manner of Collision	Road Surface	Ambient Light	Weather Condition	Non Motorized	Bike Ped
1	2407937	20-Dec-2008	10:57:00 AM	Non-fatal injury	Rear-end	Snow	Daylight	Cloudy/Snow		
2	2578548	17-Mar-2010	6:42:00 PM	Property damage only (nc	Angle	Dry	Daylight	Clear		
3	2615173	01-Jul-2010	5:07:00 PM	Property damage only (nc	Rear-end	Dry	Daylight	Cloudy		
4	2567113	14-Feb-2010	11:58:00 AM	Property damage only (nc	Rear-end	Dry	Daylight	Clear		
5	2627647	04-Aug-2010	6:49:00 PM	Property damage only (nc	Sideswipe, same direction	Dry	Daylight	Cloudy		
6	2618106	12-Jul-2010	9:32:00 AM	Non-fatal injury	Rear-end	Dry	Daylight	Clear		
7	2390906	30-Oct-2008	12:36:00 PM	Non-fatal injury	Rear-end	Dry	Daylight	Clear		
8	2396095	11-Nov-2008	3:10:00 PM	Property damage only (nc	Sideswipe, same direction	Dry	Daylight	Cloudy		
9	2293962	01-Mar-2008	6:42:00 AM	Non-fatal injury	Single vehicle crash	Snow	Daylight	Snow		
10	2618103	09-Jul-2010	7:12:00 PM	Property damage only (nc	Rear-end	Dry	Daylight	Clear		
11	1000002	6-Oct-2010	6:37:00 PM	Property damage only (nc	Single vehicle crash	Wet	Dark - lighted road	Rain		
12	2673295	03-Dec-2010	5:24:00 PM	Property damage only (nc	Sideswipe, same direction	Dry	Dark - lighted road	Cloudy/Clear		
13	2581588	30-Mar-2010	9:35:00 PM	Property damage only (nc	Rear-end	Dry	Dark - lighted road	Rain		
14	1000003	8-Dec-2012	9:02:00 PM	Property damage only (nc	Rear-end	Dry	Dark - lighted road	Clear		
15	1000004	21-Aug-2012	6:50:00 AM	Property damage only (nc	Angle	Dry	Daylight	Cloudy		
16	1000005	30-Jun-2012	11:55:00 PM	Non-fatal injury	Sideswipe, same direction	Dry	Dark - lighted road	Clear		
17	1000006	10-Mar-2011	10:15:00 AM	Non-fatal injury	Angle	Dry	Daylight	Clear		
18	1000007	22-Jan-2011	3:11:00 PM	Property damage only (nc	Angle	Dry	Daylight	Clear		
19	2484936	01-Jul-2009	5:43:00 PM	Property damage only (nc	Rear-end	Wet	Daylight	Rain		
20	2432594	17-Feb-2009	2:35:00 AM	Non-fatal injury	Angle	Dry	Daylight	Clear/Clear		
21	2262826	30-Nov-2007	5:30:00 PM	Property damage only (nc	Rear-end	Wet	Dark - lighted road	Cloudy		
22	2230807	20-Apr-2007	10:30:00 PM	Non-fatal injury	Rear-end	Dry	Dark - lighted road	Clear		
23	2230477	22-May-2007	11:56:00 AM	Property damage only (nc	Sideswipe, same direction	Dry	Daylight	Clear		
24	2195387	04-Jun-2007	10:17:00 AM	Non-fatal injury	Rear-end	Wet	Daylight	Rain		
25	2481766	12-Jun-2009	12:22:00 PM	Property damage only (nc	Angle	Dry	Daylight	Clear		
26	2493428	14-Jul-2009	12:04:00 PM	Non-fatal injury	Rear-end	Dry	Daylight	Clear		
27	2266447	27-Dec-2007	6:00:00 PM	Property damage only (nc	Angle	Wet	Dark - lighted road	Rain/Cloudy		
28	2232841	07-Sep-2007	9:04:00 AM	Property damage only (nc	Rear-end	Dry	Daylight	Clear		
29	2511319	04-Sep-2009	9:44:00 AM	Property damage only (nc	Angle	Dry	Daylight	Clear		
30	2614028	24-Jun-2010	2:00:00 PM	Non-fatal injury	Angle	Dry	Daylight	Clear		
31	2151161	12-Feb-2007	2:31:00 PM	Property damage only (nc	Sideswipe, same direction	Dry	Daylight	Clear		
35	2174066	05-Apr-2007	9:42:00 PM	Non-fatal injury	Single vehicle crash	Snow	Dark - lighted road	Snow		
	2333628	16-Jun-2008	1:11:00 PM	Property damage only (nc	Rear-end	Wet	Daylight	Rain		
	2364051	27-Aug-2008	10:05:00 AM	Property damage only (nc	Angle	Dry	Daylight	Clear		
	2523234	26-Sep-2009	3:51:00 PM	Non-fatal injury	Angle	Dry	Daylight	Clear		
	2369762	28-Feb-2007	10:00:00 AM	Not Reported	Not reported	Dry	Daylight	Clear		

## Route 30 at Whittier Street

Collision Diagram ID	Crash Number	Crash Date	Crash Time	Crash Severity	Manner of Collision	Road Surface	Ambient Light	Weather Condition	Non Motorized	Bike Ped
	2194494	25-May-2007	2:37:00 PM	Property damage only (nc	Single vehicle crash	Dry	Daylight	Clear		
	2347890	15-Nov-2007	6:01:00 AM	Not Reported	Rear-end	Wet	Dark - lighted ro	Rain		
	2406068	14-Jan-2008	8:30:00 AM	Property damage only (nc	Not reported	Dry	Daylight	Cloudy		
	2296047	09-Jan-2007	3:10:00 AM	Property damage only (nc	Rear-end	Dry	Daylight	Clear		
	2145757	27-Jan-2007	10:37:00 AM	Non-fatal injury	Rear-end	Dry	Daylight	Cloudy		
	2329297	15-Aug-2007	1:00:00 AM	Property damage only (nc	Sideswipe, same direction	Dry	Daylight	Clear		
	2233096	13-Sep-2007	3:12:00 PM	Property damage only (nc	Rear-end	Dry	Daylight	Clear		
	2364729	15-Sep-2007	6:30:00 PM	Property damage only (nc	Rear-end	Dry	Daylight	Clear		
	2376539	19-Dec-2007	5:45:00 PM	Property damage only (nc	Sideswipe, same direction	Wet	Dark - lighted ro	Clear		
	2393581	20-Dec-2007	10:00:00 AM	Non-fatal injury	Rear-end	Snow	Daylight	Snow		
	2454873	18-Jan-2008	11:30:00 AM	Non-fatal injury	Rear-end	Dry	Daylight	Clear		
	2500106	31-Jan-2008	9:50:00 PM	Property damage only (nc	Sideswipe, opposite direc	Dry	Dark - lighted ro	Clear		
	2444106	05-Mar-2008	2:00:00 AM	Non-fatal injury	Angle	Dry	Daylight	Clear		
	2457701	01-Apr-2008	7:53:00 AM	Property damage only (nc	Rear-end	Dry	Dark - lighted ro	Clear		
	2473744	30-May-2008	10:20:00 AM	Property damage only (nc	Sideswipe, same direction	Dry	Daylight	Clear		
	2507317	25-Jun-2008	8:40:00 AM	Property damage only (nc	Angle	Dry	Daylight	Clear		
	2481999	22-Aug-2008	1:40:00 AM	Property damage only (nc	Rear-end	Dry	Daylight	Clear		
	2525597	09-Oct-2009	10:16:00 PM	Non-fatal injury	Rear-end	Wet	Dark - lighted ro	Rain		
	2536623	13-Nov-2009	10:21:00 AM	Property damage only (nc	Angle	Dry	Daylight	Clear		
	2551040	16-Nov-2009	11:43:00 AM	Non-fatal injury	Rear-end	Dry	Daylight	Clear		
	2542039	30-Nov-2009	12:50:00 PM	Property damage only (nc	Angle	Wet	Daylight	Rain		
	2551620	18-Dec-2009	11:10:00 AM	Property damage only (nc	Rear-end	Dry	Daylight	Clear		
	2567119	15-Feb-2010	3:30:00 PM	Property damage only (nc	Angle	Dry	Daylight	Clear		
	2605417	04-Jun-2010	1:40:00 AM	Property damage only (nc	Single vehicle crash	Dry	Dark - lighted ro	Clear/Clear		
	2622627	21-Jul-2010	9:45:00 AM	Unknown	Unknown	Dry	Daylight	Clear		
	2627635	26-Jul-2010	10:57:00 AM	Non-fatal injury	Angle	Dry	Daylight	Clear		
	2674267	18-Nov-2010	5:31:00 PM	Property damage only (nc	Sideswipe, same direction	Dry	Dark - roadway	Clear/Clear		

Route 30 at Ring Road

Collision Diagram ID	Crash Number	Crash Date	Crash Time	Crash Severity	Manner of Collision	Road Surface	Ambient Light	Weather Condition	Non Motorized	Bike Ped
1	2674270	21-Dec-2010	12:40:00 PM	Property damage only (n	Sideswipe, same di	Dry	Daylight	Clear/Clear		
2	2551004	02-Jan-2010	9:37:00 AM	Property damage only (n	Angle	Wet	Daylight	Snow		
3	1000003	15-Feb-2010	3:30:00 PM	Property damage only (n	Angle	Dry	Daylight	Clear		
4	1000002	4-Jun-2010	1:40:00 AM	Property damage only (n	Single Vehicle Cras	Dry	Dark - lighted r	Clear/Clear		
5	1000001	28-Nov-2011	4:20:00 PM	Property damage only (n	Angle	Dry	Daylight	Clear		
6	1000000	7-Jan-2011	7:50:00 AM	Property damage only (n	Rear-end	Dry	Daylight	Cloudy/Cloudy		
7	2252303	20-Nov-2007	10:30:00 PM	Property damage only (n	Angle	Wet	Dark - lighted r	Rain		
9	2220834	25-Jul-2007	5:52:00 PM	Property damage only (n	Rear-end	Dry	Daylight	Clear/Clear		
10	2400574	01-Dec-2008	12:24:00 PM	Property damage only (n	Angle	Wet	Daylight	Cloudy		
11	2342451	08-Jul-2008	3:55:00 PM	Property damage only (n	Angle	Dry	Daylight	Clear		
14	2634760	24-Aug-2010	12:23:00 PM	Property damage only (n	Rear-end	Wet	Daylight	Rain		
	2295834	13-Mar-2008	2:36:00 PM	Property damage only (n	Sideswipe, opposit	Dry	Daylight	Clear		
	2576736	09-Mar-2010	9:12:00 AM	Property damage only (n	Head-on	Wet	Daylight	Clear		
	2575277	11-Mar-2010	3:41:00 PM	Property damage only (n	Rear-to-rear	Wet	Daylight	Cloudy		
	2638606	07-Sep-2010	4:45:00 PM	Property damage only (n	Rear-end	Dry	Daylight	Clear		
	2341059	19-Jul-2007	10:30:00 AM	Property damage only (n	Sideswipe, same di	Dry	Daylight	Clear		
	2303334	23-Dec-2007	11:00:00 AM	Property damage only (n	Sideswipe, same di	Dry	Daylight	Clear		
	2449765	22-Feb-2008	2:40:00 PM	Property damage only (n	Sideswipe, same di	Snow	Daylight	Snow		
	2540970	26-Nov-2009	10:06:00 PM	Property damage only (n	Rear-end	Dry	Dark - lighted r	Clear		
	2625351	02-Aug-2010	3:15:00 PM	Property damage only (n	Angle	Dry	Daylight	Clear		
	2684958	29-Dec-2010	10:59:00 AM	Property damage only (n	Unknown	Wet	Daylight	Cloudy/Cloudy		





## **Appendix D: Intersection Capacity and Levels of Service Analyses**

## **Existing Conditions: AM Peak Hour**

# HCM Signalized Intersection Capacity Analysis

## 3: Ring Rd/Shoppers World Way & Cochituate Rd

7/9/2013



Movement	EBL	EBT	EBR	WBL	WBT	WBR	NBL	NBT	NBR	SBL	SBT	SBR
Lane Configurations												
Volume (vph)	120	800	65	25	710	85	35	30	25	40	15	100
Ideal Flow (vphpl)	1900	1900	1900	1900	1900	1900	1900	1900	1900	1900	1900	1900
Total Lost time (s)	6.2	6.3	6.3	6.2	6.3	6.3	5.9	5.9		5.9	5.9	5.9
Lane Util. Factor	1.00	0.95	1.00	1.00	0.95	1.00	0.97	1.00		0.95	0.95	1.00
Frt	1.00	1.00	0.85	1.00	1.00	0.85	1.00	0.93		1.00	1.00	0.85
Flt Protected	0.95	1.00	1.00	0.95	1.00	1.00	0.95	1.00		0.95	0.98	1.00
Satd. Flow (prot)	1770	3539	1583	1770	3539	1583	3433	1735		1681	1729	1583
Flt Permitted	0.95	1.00	1.00	0.95	1.00	1.00	0.95	1.00		0.95	0.98	1.00
Satd. Flow (perm)	1770	3539	1583	1770	3539	1583	3433	1735		1681	1729	1583
Peak-hour factor, PHF	0.93	0.93	0.93	0.93	0.93	0.93	0.93	0.93	0.93	0.93	0.93	0.93
Adj. Flow (vph)	129	860	70	27	763	91	38	32	27	43	16	108
RTOR Reduction (vph)	0	0	36	0	0	55	0	25	0	0	0	101
Lane Group Flow (vph)	129	860	34	27	763	36	38	34	0	29	30	7
Turn Type	Prot	NA	pt+ov	Prot	NA	pt+ov	Split	NA		Split	NA	Prot
Protected Phases	1	6	6 8	5	2	2 4	8	8		4	4	4
Permitted Phases												
Actuated Green, G (s)	9.5	33.7	38.6	2.6	26.8	31.7	4.9	4.9		4.9	4.9	4.9
Effective Green, g (s)	9.5	33.7	38.6	2.6	26.8	31.7	4.9	4.9		4.9	4.9	4.9
Actuated g/C Ratio	0.12	0.42	0.48	0.03	0.34	0.40	0.06	0.06		0.06	0.06	0.06
Clearance Time (s)	6.2	6.3		6.2	6.3		5.9	5.9		5.9	5.9	5.9
Vehicle Extension (s)	3.0	3.0		3.0	3.0		3.0	3.0		3.0	3.0	3.0
Lane Grp Cap (vph)	210	1490	763	57	1185	627	210	106		102	105	96
v/s Ratio Prot	0.07	c0.24	0.02	0.02	c0.22	0.02	0.01	c0.02		0.02	c0.02	0.00
v/s Ratio Perm												
v/c Ratio	0.61	0.58	0.04	0.47	0.64	0.06	0.18	0.32		0.28	0.29	0.07
Uniform Delay, d1	33.5	17.7	10.9	38.0	22.6	14.9	35.6	35.9		35.9	35.9	35.4
Progression Factor	0.84	0.50	1.00	0.86	1.78	1.00	1.00	1.00		1.00	1.00	1.00
Incremental Delay, d2	4.6	1.4	0.0	5.1	1.0	0.0	0.4	1.7		1.5	1.5	0.3
Delay (s)	32.8	10.3	11.0	37.7	41.1	15.0	36.1	37.7		37.4	37.4	35.7
Level of Service	C	B	B	D	D	B	D	D		D	D	D
Approach Delay (s)		13.1			38.3			37.0			36.3	
Approach LOS		B			D			D			D	

### Intersection Summary

HCM 2000 Control Delay	26.0	HCM 2000 Level of Service	C
HCM 2000 Volume to Capacity ratio	0.53		
Actuated Cycle Length (s)	80.0	Sum of lost time (s)	29.3
Intersection Capacity Utilization	49.8%	ICU Level of Service	A
Analysis Period (min)	15		
c Critical Lane Group			

# Phasings

## 3: Ring Rd/Shoppers World Way & Cochituate Rd

7/9/2013



Lane Group	EBL	EBT	EBR	WBL	WBT	WBR	NBL	NBT	SBL	SBT	SBR	ø9
Lane Configurations												
Volume (vph)	120	800	65	25	710	85	35	30	40	15	100	
Turn Type	Prot	NA	pt+ov	Prot	NA	pt+ov	Split	NA	Split	NA	Prot	
Protected Phases	1	6	6 8	5	2	2 4	8	8	4	4	4	9
Permitted Phases												
Detector Phase	1	6	6 8	5	2	2 4	8	8	4	4	4	
Switch Phase												
Minimum Initial (s)	5.0	9.0		5.0	9.0		6.0	6.0	6.0	6.0	6.0	1.0
Minimum Split (s)	11.2	15.3		11.2	15.3		11.9	11.9	11.9	11.9	11.9	28.0
Total Split (s)	12.0	16.0		12.0	16.0		12.0	12.0	12.0	12.0	12.0	28.0
Total Split (%)	15.0%	20.0%		15.0%	20.0%		15.0%	15.0%	15.0%	15.0%	15.0%	35%
Yellow Time (s)	3.2	3.2		3.2	3.2		3.2	3.2	3.2	3.2	3.2	3.0
All-Red Time (s)	3.0	3.1		3.0	3.1		2.7	2.7	2.7	2.7	2.7	2.0
Lost Time Adjust (s)	0.0	0.0		0.0	0.0		0.0	0.0	0.0	0.0	0.0	
Total Lost Time (s)	6.2	6.3		6.2	6.3		5.9	5.9	5.9	5.9	5.9	
Lead/Lag	Lag	Lag		Lead	Lead							
Lead-Lag Optimize?	Yes			Yes								
Recall Mode	None	C-Min		None	Min		None	None	None	None	None	None

### Intersection Summary

Cycle Length: 80

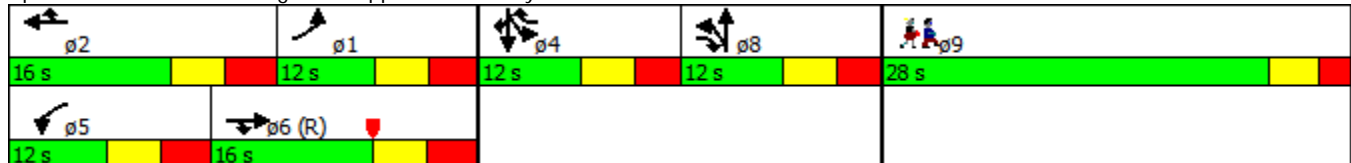
Actuated Cycle Length: 80

Offset: 73 (91%), Referenced to phase 6:EBT, Start of Yellow

Natural Cycle: 90

Control Type: Actuated-Coordinated

### Splits and Phases: 3: Ring Rd/Shoppers World Way & Cochituate Rd





# HCM Signalized Intersection Capacity Analysis

## 4: Shopper World Dr/Whittier St & Cochituate Rd

7/9/2013



Movement	EBL	EBT	EBR	WBL	WBT	WBR	NBL	NBT	NBR	SBL	SBT	SBR
Lane Configurations												
Volume (vph)	75	740	55	180	760	115	25	85	20	165	130	40
Ideal Flow (vphpl)	1900	1900	1900	1900	1900	1900	1900	1900	1900	1900	1900	1900
Total Lost time (s)	5.0	5.0	5.0	5.0	5.0			5.0	5.0	5.0	5.0	5.0
Lane Util. Factor	1.00	0.95	0.88	1.00	0.95			0.95	1.00	0.91	0.91	1.00
Frt	1.00	1.00	0.85	1.00	0.98			1.00	0.85	1.00	1.00	0.85
Flt Protected	0.95	1.00	1.00	0.95	1.00			0.99	1.00	0.95	0.98	1.00
Satd. Flow (prot)	1770	3539	2787	1770	3469			3499	1583	1610	3333	1583
Flt Permitted	0.95	1.00	1.00	0.95	1.00			0.99	1.00	0.95	0.98	1.00
Satd. Flow (perm)	1770	3539	2787	1770	3469			3499	1583	1610	3333	1583
Peak-hour factor, PHF	0.93	0.93	0.93	0.93	0.93	0.93	0.93	0.93	0.93	0.93	0.93	0.93
Adj. Flow (vph)	81	796	59	194	817	124	27	91	22	177	140	43
RTOR Reduction (vph)	0	0	40	0	11	0	0	0	16	0	0	36
Lane Group Flow (vph)	81	796	19	194	930	0	0	118	6	103	214	7
Turn Type	Prot	NA	pt+ov	Prot	NA		Split	NA	pt+ov	Split	NA	pt+ov
Protected Phases	1	6	6 8	5	2		8	8	8 5	4	4	4 1
Permitted Phases												
Actuated Green, G (s)	6.3	20.6	26.2	15.6	29.9			5.6	21.2	7.6	7.6	13.9
Effective Green, g (s)	6.3	20.6	26.2	15.6	29.9			5.6	21.2	7.6	7.6	13.9
Actuated g/C Ratio	0.08	0.26	0.33	0.19	0.37			0.07	0.26	0.09	0.09	0.17
Clearance Time (s)	5.0	5.0		5.0	5.0			5.0		5.0	5.0	
Vehicle Extension (s)	2.0	2.0		2.0	2.0			2.0		2.0	2.0	
Lane Grp Cap (vph)	139	911	912	345	1296			244	419	152	316	275
v/s Ratio Prot	0.05	c0.22	0.01	c0.11	c0.27			c0.03	0.00	0.06	c0.06	0.00
v/s Ratio Perm												
v/c Ratio	0.58	0.87	0.02	0.56	0.72			0.48	0.01	0.68	0.68	0.03
Uniform Delay, d1	35.6	28.5	18.2	29.1	21.4			35.8	21.7	35.0	35.0	27.4
Progression Factor	1.34	0.69	1.00	1.21	0.25			1.00	1.00	1.00	1.00	1.00
Incremental Delay, d2	3.7	10.7	0.0	1.1	3.0			0.6	0.0	9.0	4.5	0.0
Delay (s)	51.4	30.3	18.2	36.3	8.2			36.4	21.7	44.1	39.5	27.5
Level of Service	D	C	B	D	A			D	C	D	D	C
Approach Delay (s)		31.3			13.0			34.1			39.4	
Approach LOS		C			B			C			D	

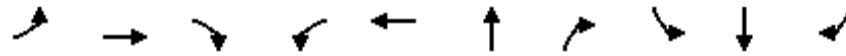
### Intersection Summary

HCM 2000 Control Delay	24.5	HCM 2000 Level of Service	C
HCM 2000 Volume to Capacity ratio	0.66		
Actuated Cycle Length (s)	80.0	Sum of lost time (s)	26.0
Intersection Capacity Utilization	57.7%	ICU Level of Service	B
Analysis Period (min)	15		
c Critical Lane Group			

# Phasings

## 4: Shopper World Dr/Whittier St & Cochituate Rd

7/9/2013



Lane Group	EBL	EBT	EBR	WBL	WBT	NBT	NBR	SBL	SBT	SBR	ø9
Lane Configurations											
Volume (vph)	75	740	55	180	760	85	20	165	130	40	
Turn Type	Prot	NA	pt+ov	Prot	NA	NA	pt+ov	Split	NA	pt+ov	
Protected Phases	1	6	6 8	5	2	8	8 5	4	4	4 1	9
Permitted Phases											
Detector Phase	1	6	6 8	5	2	8	8 5	4	4	4 1	
Switch Phase											
Minimum Initial (s)	6.0	6.0		6.0	6.0	6.0		6.0	6.0		1.0
Minimum Split (s)	11.0	11.0		11.0	11.0	11.0		11.0	11.0		29.0
Total Split (s)	12.0	13.0		12.0	13.0	13.0		13.0	13.0		29.0
Total Split (%)	15.0%	16.3%		15.0%	16.3%	16.3%		16.3%	16.3%		36%
Yellow Time (s)	4.0	4.0		4.0	4.0	4.0		4.0	4.0		3.0
All-Red Time (s)	1.0	1.0		1.0	1.0	1.0		1.0	1.0		3.0
Lost Time Adjust (s)	0.0	0.0		0.0	0.0	0.0		0.0	0.0		
Total Lost Time (s)	5.0	5.0		5.0	5.0	5.0		5.0	5.0		
Lead/Lag	Lead	Lag		Lead	Lag						
Lead-Lag Optimize?	Yes	Yes		Yes	Yes						
Recall Mode	None	C-Max		None	Max	None		None	None		None

### Intersection Summary

Cycle Length: 80

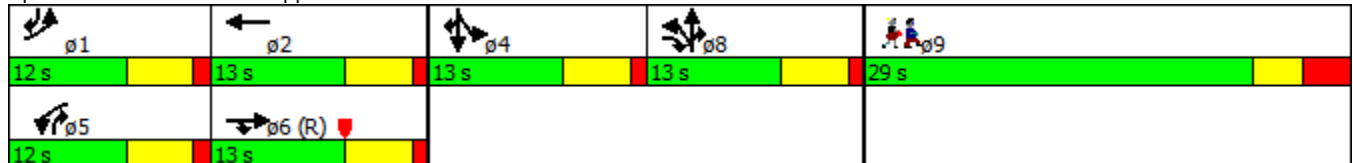
Actuated Cycle Length: 80

Offset: 0 (0%), Referenced to phase 6:EBT, Start of Yellow, Master Intersection

Natural Cycle: 90

Control Type: Actuated-Coordinated

Splits and Phases: 4: Shopper World Dr/Whittier St & Cochituate Rd



# HCM Signalized Intersection Capacity Analysis

## 5: Burr St & Cochituate Rd

7/9/2013



Movement	EBL	EBT	EBR	WBL	WBT	WBR	NBL	NBT	NBR	SBL	SBT	SBR
Lane Configurations												
Volume (vph)	140	710	5	0	990	1010	5	75	155	80	25	20
Ideal Flow (vphpl)	1900	1900	1900	1900	1900	1900	1900	1900	1900	1900	1900	1900
Total Lost time (s)	5.0	5.0			5.0	5.0		5.0	4.0	5.0	5.0	
Lane Util. Factor	1.00	0.95			0.95	1.00		1.00	1.00	0.95	0.95	
Frt	1.00	1.00			1.00	0.85		1.00	0.85	1.00	0.95	
Flt Protected	0.95	1.00			1.00	1.00		1.00	1.00	0.95	0.99	
Satd. Flow (prot)	1770	3536			3539	1583		1857	1583	1681	1660	
Flt Permitted	0.95	1.00			1.00	1.00		1.00	1.00	0.95	0.99	
Satd. Flow (perm)	1770	3536			3539	1583		1857	1583	1681	1660	
Peak-hour factor, PHF	0.93	0.93	0.93	0.93	0.93	0.93	0.93	0.93	0.93	0.93	0.93	0.93
Adj. Flow (vph)	151	763	5	0	1065	1086	5	81	167	86	27	22
RTOR Reduction (vph)	0	1	0	0	0	264	0	0	0	0	20	0
Lane Group Flow (vph)	151	767	0	0	1065	822	0	86	167	68	47	0
Turn Type	Prot	NA			NA	Perm	Split	NA	Free	Split	NA	
Protected Phases	5	2			6		4	4		8	8	
Permitted Phases						6			Free			
Actuated Green, G (s)	8.2	54.0			40.8	40.8		4.8	80.0	6.2	6.2	
Effective Green, g (s)	8.2	54.0			40.8	40.8		4.8	80.0	6.2	6.2	
Actuated g/C Ratio	0.10	0.68			0.51	0.51		0.06	1.00	0.08	0.08	
Clearance Time (s)	5.0	5.0			5.0	5.0		5.0		5.0	5.0	
Vehicle Extension (s)	3.0	3.0			3.0	3.0		3.0		3.0	3.0	
Lane Grp Cap (vph)	181	2386			1804	807		111	1583	130	128	
v/s Ratio Prot	c0.09	0.22			0.30			c0.05		c0.04	0.03	
v/s Ratio Perm						c0.52			0.11			
v/c Ratio	0.83	0.32			0.59	1.02		0.77	0.11	0.52	0.36	
Uniform Delay, d1	35.2	5.4			13.7	19.6		37.1	0.0	35.5	35.0	
Progression Factor	1.02	0.62			1.00	1.00		1.00	1.00	1.00	1.00	
Incremental Delay, d2	21.2	0.3			1.4	36.6		27.9	0.1	3.8	1.8	
Delay (s)	57.2	3.6			15.2	56.2		65.0	0.1	39.2	36.8	
Level of Service	E	A			B	E		E	A	D	D	
Approach Delay (s)		12.4			35.9			22.2			38.0	
Approach LOS		B			D			C			D	

### Intersection Summary

HCM 2000 Control Delay	28.7	HCM 2000 Level of Service	C
HCM 2000 Volume to Capacity ratio	0.92		
Actuated Cycle Length (s)	80.0	Sum of lost time (s)	20.0
Intersection Capacity Utilization	87.8%	ICU Level of Service	E
Analysis Period (min)	15		
c	Critical Lane Group		

# Phasings

## 5: Burr St & Cochituate Rd

7/9/2013



Lane Group	EBL	EBT	WBT	WBR	NBT	NBR	SBL	SBT
Lane Configurations								
Volume (vph)	140	710	990	1010	75	155	80	25
Turn Type	Prot	NA	NA	Perm	NA	Free	Split	NA
Protected Phases	5	2	6		4		8	8
Permitted Phases				6		Free		
Detector Phase	5	2	6	6	4		8	8
Switch Phase								
Minimum Initial (s)	6.0	12.0	12.0	12.0	6.0		6.0	6.0
Minimum Split (s)	11.0	17.0	17.0	17.0	11.0		11.0	11.0
Total Split (s)	11.0	56.0	45.0	45.0	11.0		13.0	13.0
Total Split (%)	13.8%	70.0%	56.3%	56.3%	13.8%		16.3%	16.3%
Yellow Time (s)	3.0	3.0	3.0	3.0	3.0		3.0	3.0
All-Red Time (s)	2.0	2.0	2.0	2.0	2.0		2.0	2.0
Lost Time Adjust (s)	0.0	0.0	0.0	0.0	0.0		0.0	0.0
Total Lost Time (s)	5.0	5.0	5.0	5.0	5.0		5.0	5.0
Lead/Lag	Lead		Lag	Lag				
Lead-Lag Optimize?	Yes		Yes	Yes				
Recall Mode	None	C-Max	C-Max	C-Max	None		None	None

### Intersection Summary

Cycle Length: 80  
 Actuated Cycle Length: 80  
 Offset: 56 (70%), Referenced to phase 2:EBT and 6:WBT, Start of Yellow  
 Natural Cycle: 90  
 Control Type: Actuated-Coordinated

Splits and Phases: 5: Burr St & Cochituate Rd



# HCM Signalized Intersection Capacity Analysis

## 6: Speen St & Cochituate Rd

7/9/2013



Movement	EBL	EBT	EBR	WBL	WBT	WBR	NBL	NBT	NBR	SBL	SBT	SBR
Lane Configurations												
Volume (vph)	285	920	930	150	320	70	580	495	370	105	335	240
Ideal Flow (vphpl)	1900	1900	1900	1900	1900	1900	1900	1900	1900	1900	1900	1900
Total Lost time (s)	5.5	5.5	5.5	5.5	5.5		5.5	6.0		5.5	6.0	6.0
Lane Util. Factor	1.00	0.91	0.91	1.00	0.95		0.97	0.95		1.00	0.95	1.00
Frt	1.00	0.98	0.85	1.00	0.97		1.00	0.94		1.00	1.00	0.85
Flt Protected	0.95	1.00	1.00	0.95	1.00		0.95	1.00		0.95	1.00	1.00
Satd. Flow (prot)	1770	3323	1441	1770	3444		3433	3312		1770	3539	1583
Flt Permitted	0.95	1.00	1.00	0.95	1.00		0.95	1.00		0.95	1.00	1.00
Satd. Flow (perm)	1770	3323	1441	1770	3444		3433	3312		1770	3539	1583
Peak-hour factor, PHF	0.96	0.96	0.96	0.96	0.96	0.96	0.96	0.96	0.96	0.96	0.96	0.96
Adj. Flow (vph)	297	958	969	156	333	73	604	516	385	109	349	250
RTOR Reduction (vph)	0	7	229	0	10	0	0	80	0	0	0	177
Lane Group Flow (vph)	297	1096	595	156	396	0	604	821	0	109	349	73
Turn Type	Prot	NA	pt+ov	Prot	NA		Prot	NA		Prot	NA	pt+ov
Protected Phases	5	2	2 7	1	6		7	4		3	8	8 5
Permitted Phases												
Actuated Green, G (s)	26.0	46.9	81.4	14.6	35.5		29.0	30.6		12.5	14.1	40.1
Effective Green, g (s)	26.0	46.9	81.4	14.6	35.5		29.0	30.6		12.5	14.1	40.1
Actuated g/C Ratio	0.19	0.34	0.60	0.11	0.26		0.21	0.22		0.09	0.10	0.29
Clearance Time (s)	5.5	5.5		5.5	5.5		5.5	6.0		5.5	6.0	
Vehicle Extension (s)	3.0	3.0		3.0	3.0		3.0	3.0		3.0	3.0	
Lane Grp Cap (vph)	336	1139	857	188	893		727	740		161	364	464
v/s Ratio Prot	c0.17	c0.33	0.41	0.09	0.11		c0.18	c0.25		0.06	0.10	0.05
v/s Ratio Perm												
v/c Ratio	0.88	0.96	0.69	0.83	0.44		0.83	1.11		0.68	0.96	0.16
Uniform Delay, d1	53.9	44.1	19.1	59.9	42.4		51.6	53.1		60.2	61.1	35.8
Progression Factor	1.00	1.00	1.00	1.00	1.00		1.00	1.00		1.00	1.00	1.00
Incremental Delay, d2	22.9	18.3	2.5	25.0	0.4		8.0	67.3		10.7	36.0	0.2
Delay (s)	76.8	62.4	21.6	84.9	42.7		59.6	120.4		70.9	97.1	36.0
Level of Service	E	E	C	F	D		E	F		E	F	D
Approach Delay (s)		49.2			54.4			96.0			71.5	
Approach LOS		D			D			F			E	

### Intersection Summary

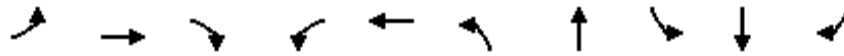
HCM 2000 Control Delay	67.0	HCM 2000 Level of Service	E
HCM 2000 Volume to Capacity ratio	0.99		
Actuated Cycle Length (s)	136.8	Sum of lost time (s)	28.0
Intersection Capacity Utilization	93.8%	ICU Level of Service	F
Analysis Period (min)	15		
c Critical Lane Group			



# Phasings

## 6: Speen St & Cochituate Rd

7/9/2013

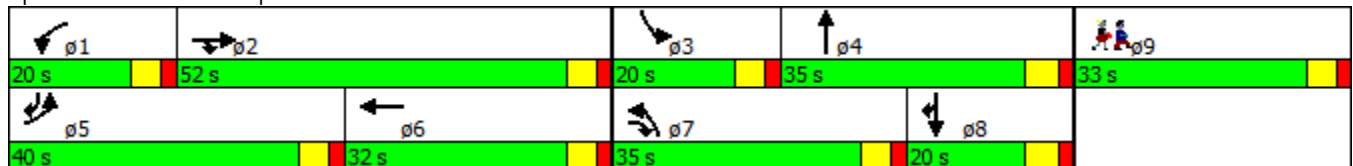


Lane Group	EBL	EBT	EBR	WBL	WBT	NBL	NBT	SBL	SBT	SBR	ø9
Lane Configurations											
Volume (vph)	285	920	930	150	320	580	495	105	335	240	
Turn Type	Prot	NA	pt+ov	Prot	NA	Prot	NA	Prot	NA	pt+ov	
Protected Phases	5	2	2 7	1	6	7	4	3	8	8 5	9
Permitted Phases											
Detector Phase	5	2	2 7	1	6	7	4	3	8	8 5	
Switch Phase											
Minimum Initial (s)	5.0	5.0		5.0	5.0	5.0	5.0	5.0	5.0		5.0
Minimum Split (s)	10.5	11.0		10.5	11.0	10.5	11.0	10.5	11.0		33.0
Total Split (s)	40.0	52.0		20.0	32.0	35.0	35.0	20.0	20.0		33.0
Total Split (%)	25.0%	32.5%		12.5%	20.0%	21.9%	21.9%	12.5%	12.5%		21%
Yellow Time (s)	3.5	3.5		3.5	3.5	3.5	4.0	3.5	4.0		3.5
All-Red Time (s)	2.0	2.0		2.0	2.0	2.0	2.0	2.0	2.0		2.0
Lost Time Adjust (s)	0.0	0.0		0.0	0.0	0.0	0.0	0.0	0.0		0.0
Total Lost Time (s)	5.5	5.5		5.5	5.5	5.5	6.0	5.5	6.0		6.0
Lead/Lag	Lead	Lag		Lead	Lag	Lead	Lag	Lead	Lag		
Lead-Lag Optimize?	Yes	Yes		Yes	Yes	Yes	Yes	Yes	Yes		
Recall Mode	None	None		None	None	None	None	None	None		None

### Intersection Summary

Cycle Length: 160  
 Actuated Cycle Length: 132.4  
 Natural Cycle: 150  
 Control Type: Actuated-Uncoordinated

### Splits and Phases: 6: Speen St & Cochituate Rd



# HCM Signalized Intersection Capacity Analysis

## 7: Cochituate Rd & TJX Driveway

7/9/2013



Movement	EBL	EBT	WBT	WBR	SBL	SBR
Lane Configurations						
Volume (vph)	610	735	480	115	10	20
Ideal Flow (vphpl)	1900	1900	1900	1900	1900	1900
Total Lost time (s)	5.0	5.0	5.0	5.0	5.0	5.0
Lane Util. Factor	1.00	1.00	1.00	1.00	1.00	1.00
Frbp, ped/bikes	1.00	1.00	1.00	1.00	1.00	1.00
Flpb, ped/bikes	1.00	1.00	1.00	1.00	1.00	1.00
Frt	1.00	1.00	1.00	0.85	1.00	0.85
Flt Protected	0.95	1.00	1.00	1.00	0.95	1.00
Satd. Flow (prot)	1770	1863	1863	1583	1770	1583
Flt Permitted	0.21	1.00	1.00	1.00	0.95	1.00
Satd. Flow (perm)	394	1863	1863	1583	1770	1583
Peak-hour factor, PHF	0.92	0.92	0.92	0.92	0.92	0.92
Adj. Flow (vph)	663	799	522	125	11	22
RTOR Reduction (vph)	0	0	0	72	0	12
Lane Group Flow (vph)	663	799	522	53	11	10
Confl. Peds. (#/hr)						2
Turn Type	pm+pt	NA	NA	Perm	NA	pt+ov
Protected Phases	1	6	2		3	3 1
Permitted Phases	6			2		
Actuated Green, G (s)	64.1	64.1	28.7	28.7	2.2	37.6
Effective Green, g (s)	64.1	64.1	28.7	28.7	2.2	37.6
Actuated g/C Ratio	0.74	0.74	0.33	0.33	0.03	0.44
Clearance Time (s)	5.0	5.0	5.0	5.0	5.0	
Vehicle Extension (s)	3.0	3.0	3.0	3.0	3.0	
Lane Grp Cap (vph)	776	1382	618	525	45	688
v/s Ratio Prot	c0.30	0.43	0.28		c0.01	0.01
v/s Ratio Perm	c0.33			0.03		
v/c Ratio	0.85	0.58	0.84	0.10	0.24	0.01
Uniform Delay, d1	17.8	5.0	26.8	19.9	41.3	13.9
Progression Factor	1.00	1.00	1.00	1.00	1.00	1.00
Incremental Delay, d2	9.1	0.6	10.3	0.1	2.8	0.0
Delay (s)	26.9	5.6	37.1	20.0	44.1	13.9
Level of Service	C	A	D	C	D	B
Approach Delay (s)		15.3	33.8		24.0	
Approach LOS		B	C		C	

### Intersection Summary

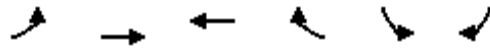
HCM 2000 Control Delay	21.0	HCM 2000 Level of Service	C
HCM 2000 Volume to Capacity ratio	0.81		
Actuated Cycle Length (s)	86.4	Sum of lost time (s)	20.0
Intersection Capacity Utilization	76.6%	ICU Level of Service	D
Analysis Period (min)	15		

c Critical Lane Group

# Phasings

## 7: Cochituate Rd & TJX Driveway

7/9/2013



Lane Group	EBL	EBT	WBT	WBR	SBL	SBR	ø9
Lane Configurations							
Volume (vph)	610	735	480	115	10	20	
Turn Type	pm+pt	NA	NA	Perm	NA	pt+ov	
Protected Phases	1	6	2		3	3 1	9
Permitted Phases	6			2			
Detector Phase	1	6	2	2	3	3 1	
Switch Phase							
Minimum Initial (s)	4.0	4.0	4.0	4.0	6.0		4.0
Minimum Split (s)	9.0	12.0	21.0	21.0	12.0		21.0
Total Split (s)	34.0	67.0	33.0	33.0	12.0		21.0
Total Split (%)	34.0%	67.0%	33.0%	33.0%	12.0%		21%
Yellow Time (s)	3.0	3.0	3.0	3.0	3.0		3.0
All-Red Time (s)	2.0	2.0	2.0	2.0	2.0		2.0
Lost Time Adjust (s)	0.0	0.0	0.0	0.0	0.0		
Total Lost Time (s)	5.0	5.0	5.0	5.0	5.0		
Lead/Lag	Lag		Lead	Lead			
Lead-Lag Optimize?	Yes		Yes	Yes			
Recall Mode	None	Min	Min	Min	None		None

### Intersection Summary

Cycle Length: 100  
 Actuated Cycle Length: 79.8  
 Natural Cycle: 100  
 Control Type: Actuated-Uncoordinated

### Splits and Phases: 7: Cochituate Rd & TJX Driveway



## **Existing Conditions: PM Peak Hour**

# HCM Signalized Intersection Capacity Analysis

## 3: Ring Rd/Shoppers World Way & Cochituate Rd

7/9/2013



Movement	EBL	EBT	EBR	WBL	WBT	WBR	NBL	NBT	NBR	SBL	SBT	SBR
Lane Configurations												
Volume (vph)	150	625	130	65	920	140	180	115	45	95	65	190
Ideal Flow (vphpl)	1900	1900	1900	1900	1900	1900	1900	1900	1900	1900	1900	1900
Total Lost time (s)	6.2	6.3	6.3	6.2	6.3	6.3	5.9	5.9		5.9	5.9	5.9
Lane Util. Factor	1.00	0.95	1.00	1.00	0.95	1.00	0.97	1.00		0.95	0.95	1.00
Frt	1.00	1.00	0.85	1.00	1.00	0.85	1.00	0.96		1.00	1.00	0.85
Flt Protected	0.95	1.00	1.00	0.95	1.00	1.00	0.95	1.00		0.95	0.99	1.00
Satd. Flow (prot)	1770	3539	1583	1770	3539	1583	3433	1785		1681	1751	1583
Flt Permitted	0.95	1.00	1.00	0.95	1.00	1.00	0.95	1.00		0.95	0.99	1.00
Satd. Flow (perm)	1770	3539	1583	1770	3539	1583	3433	1785		1681	1751	1583
Peak-hour factor, PHF	0.95	0.95	0.95	0.95	0.95	0.95	0.95	0.95	0.95	0.95	0.95	0.95
Adj. Flow (vph)	158	658	137	68	968	147	189	121	47	100	68	200
RTOR Reduction (vph)	0	0	61	0	0	0	0	13	0	0	0	187
Lane Group Flow (vph)	158	658	76	68	968	147	189	155	0	82	86	13
Turn Type	Prot	NA	pt+ov	Prot	NA	pt+ov	Split	NA		Split	NA	Prot
Protected Phases	1	6	6 8	5	2	2 4	8	8		4	4	4
Permitted Phases												
Actuated Green, G (s)	15.2	54.2	61.3	7.7	46.7	53.8	7.1	7.1		7.1	7.1	7.1
Effective Green, g (s)	15.2	54.2	61.3	7.7	46.7	53.8	7.1	7.1		7.1	7.1	7.1
Actuated g/C Ratio	0.14	0.49	0.56	0.07	0.42	0.49	0.06	0.06		0.06	0.06	0.06
Clearance Time (s)	6.2	6.3		6.2	6.3		5.9	5.9		5.9	5.9	5.9
Vehicle Extension (s)	3.0	3.0		3.0	3.0		3.0	3.0		3.0	3.0	3.0
Lane Grp Cap (vph)	244	1743	882	123	1502	774	221	115		108	113	102
v/s Ratio Prot	c0.09	0.19	0.05	0.04	c0.27	0.09	0.06	c0.09		0.05	c0.05	0.01
v/s Ratio Perm												
v/c Ratio	0.65	0.38	0.09	0.55	0.64	0.19	0.86	1.35		0.76	0.76	0.13
Uniform Delay, d1	44.9	17.4	11.3	49.5	25.1	15.8	50.9	51.5		50.6	50.6	48.5
Progression Factor	1.31	1.47	4.58	1.11	1.53	1.78	1.00	1.00		1.00	1.00	1.00
Incremental Delay, d2	5.2	0.6	0.0	3.8	0.7	0.1	26.1	202.9		25.9	25.6	0.6
Delay (s)	64.2	26.1	51.9	58.7	39.1	28.2	77.0	254.4		76.5	76.2	49.1
Level of Service	E	C	D	E	D	C	E	F		E	E	D
Approach Delay (s)		36.1			38.9			160.5			61.5	
Approach LOS		D			D			F			E	

### Intersection Summary

HCM 2000 Control Delay	56.1	HCM 2000 Level of Service	E
HCM 2000 Volume to Capacity ratio	0.68		
Actuated Cycle Length (s)	110.0	Sum of lost time (s)	29.3
Intersection Capacity Utilization	67.8%	ICU Level of Service	C
Analysis Period (min)	15		
c Critical Lane Group			

# Phasings

## 3: Ring Rd/Shoppers World Way & Cochituate Rd

7/9/2013

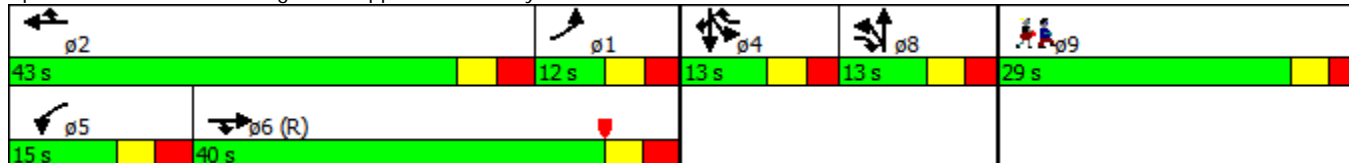


Lane Group	EBL	EBT	EBR	WBL	WBT	WBR	NBL	NBT	SBL	SBT	SBR	ø9
Lane Configurations												
Volume (vph)	150	625	130	65	920	140	180	115	95	65	190	
Turn Type	Prot	NA	pt+ov	Prot	NA	pt+ov	Split	NA	Split	NA	Prot	
Protected Phases	1	6	6 8	5	2	2 4	8	8	4	4	4	9
Permitted Phases												
Detector Phase	1	6	6 8	5	2	2 4	8	8	4	4	4	
Switch Phase												
Minimum Initial (s)	5.0	9.0		5.0	9.0		6.0	6.0	6.0	6.0	6.0	1.0
Minimum Split (s)	11.2	15.3		11.2	15.3		11.9	11.9	11.9	11.9	11.9	29.0
Total Split (s)	12.0	40.0		15.0	43.0		13.0	13.0	13.0	13.0	13.0	29.0
Total Split (%)	10.9%	36.4%		13.6%	39.1%		11.8%	11.8%	11.8%	11.8%	11.8%	26%
Yellow Time (s)	3.2	3.2		3.2	3.2		3.2	3.2	3.2	3.2	3.2	3.0
All-Red Time (s)	3.0	3.1		3.0	3.1		2.7	2.7	2.7	2.7	2.7	2.0
Lost Time Adjust (s)	0.0	0.0		0.0	0.0		0.0	0.0	0.0	0.0	0.0	0.0
Total Lost Time (s)	6.2	6.3		6.2	6.3		5.9	5.9	5.9	5.9	5.9	5.9
Lead/Lag	Lag	Lag		Lead	Lead							
Lead-Lag Optimize?	Yes	Yes		Yes	Yes							
Recall Mode	None	C-Min		None	Min		None	None	None	None	None	None

### Intersection Summary

Cycle Length: 110  
 Actuated Cycle Length: 110  
 Offset: 108 (98%), Referenced to phase 6:EBT, Start of Yellow  
 Natural Cycle: 110  
 Control Type: Actuated-Coordinated

### Splits and Phases: 3: Ring Rd/Shoppers World Way & Cochituate Rd





# HCM Signalized Intersection Capacity Analysis

## 4: Shopper World Dr/Whittier St & Cochituate Rd

7/9/2013



Movement	EBL	EBT	EBR	WBL	WBT	WBR	NBL	NBT	NBR	SBL	SBT	SBR
Lane Configurations												
Volume (vph)	60	595	110	325	940	200	105	230	115	295	350	95
Ideal Flow (vphpl)	1900	1900	1900	1900	1900	1900	1900	1900	1900	1900	1900	1900
Total Lost time (s)	5.0	5.0	5.0	5.0	5.0			5.0	5.0	5.0	5.0	5.0
Lane Util. Factor	1.00	0.95	0.88	1.00	0.95			0.95	1.00	0.91	0.91	1.00
Frt	1.00	1.00	0.85	1.00	0.97			1.00	0.85	1.00	1.00	0.85
Flt Protected	0.95	1.00	1.00	0.95	1.00			0.98	1.00	0.95	0.99	1.00
Satd. Flow (prot)	1770	3539	2787	1770	3446			3484	1583	1610	3354	1583
Flt Permitted	0.95	1.00	1.00	0.95	1.00			0.98	1.00	0.95	0.99	1.00
Satd. Flow (perm)	1770	3539	2787	1770	3446			3484	1583	1610	3354	1583
Peak-hour factor, PHF	0.95	0.95	0.95	0.95	0.95	0.95	0.95	0.95	0.95	0.95	0.95	0.95
Adj. Flow (vph)	63	626	116	342	989	211	111	242	121	311	368	100
RTOR Reduction (vph)	0	0	75	0	0	0	0	0	78	0	0	82
Lane Group Flow (vph)	63	626	41	342	1200	0	0	353	43	211	468	18
Turn Type	Prot	NA	pt+ov	Prot	NA		Split	NA	pt+ov	Split	NA	pt+ov
Protected Phases	1	6	6 8	5	2		8	8	8 5	4	4	4 1
Permitted Phases												
Actuated Green, G (s)	8.6	29.6	38.6	29.8	50.8			9.0	38.8	11.0	11.0	19.6
Effective Green, g (s)	8.6	29.6	38.6	29.8	50.8			9.0	38.8	11.0	11.0	19.6
Actuated g/C Ratio	0.08	0.27	0.35	0.27	0.46			0.08	0.35	0.10	0.10	0.18
Clearance Time (s)	5.0	5.0		5.0	5.0			5.0		5.0	5.0	
Vehicle Extension (s)	2.0	2.0		2.0	2.0			2.0		2.0	2.0	
Lane Grp Cap (vph)	138	952	977	479	1591			285	558	161	335	282
v/s Ratio Prot	0.04	0.18	0.01	c0.19	c0.35			c0.10	0.03	0.13	c0.14	0.01
v/s Ratio Perm												
v/c Ratio	0.46	0.66	0.04	0.71	0.75			1.24	0.08	1.31	1.40	0.06
Uniform Delay, d1	48.5	35.7	23.5	36.2	24.4			50.5	23.7	49.5	49.5	37.6
Progression Factor	1.22	0.80	1.43	0.64	0.71			1.00	1.00	1.00	1.00	1.00
Incremental Delay, d2	0.8	1.1	0.0	2.3	1.8			133.7	0.0	177.0	195.9	0.0
Delay (s)	60.1	29.9	33.7	25.6	19.2			184.2	23.7	226.5	245.4	37.6
Level of Service	E	C	C	C	B			F	C	F	F	D
Approach Delay (s)		32.8			20.7			143.2			213.6	
Approach LOS		C			C			F			F	

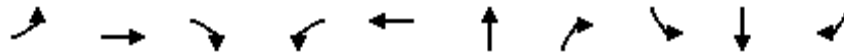
### Intersection Summary

HCM 2000 Control Delay	81.3	HCM 2000 Level of Service	F
HCM 2000 Volume to Capacity ratio	0.87		
Actuated Cycle Length (s)	110.0	Sum of lost time (s)	26.0
Intersection Capacity Utilization	75.6%	ICU Level of Service	D
Analysis Period (min)	15		
c Critical Lane Group			

# Phasings

## 4: Shopper World Dr/Whittier St & Cochituate Rd

7/9/2013

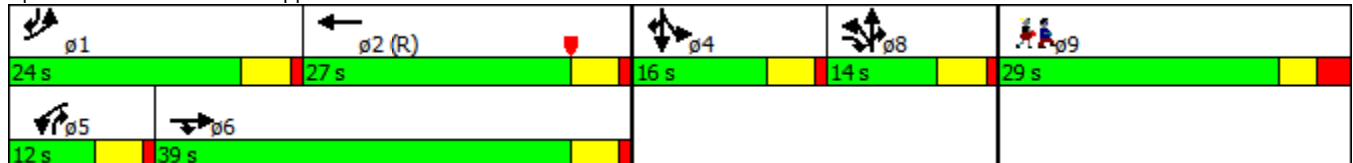


Lane Group	EBL	EBT	EBR	WBL	WBT	NBT	NBR	SBL	SBT	SBR	ø9
Lane Configurations											
Volume (vph)	60	595	110	325	940	230	115	295	350	95	
Turn Type	Prot	NA	pt+ov	Prot	NA	NA	pt+ov	Split	NA	pt+ov	
Protected Phases	1	6	6 8	5	2	8	8 5	4	4	4 1	9
Permitted Phases											
Detector Phase	1	6	6 8	5	2	8	8 5	4	4	4 1	
Switch Phase											
Minimum Initial (s)	6.0	6.0		6.0	6.0	6.0		6.0	6.0		1.0
Minimum Split (s)	12.0	11.0		12.0	12.0	11.0		11.0	11.0		29.0
Total Split (s)	24.0	39.0		12.0	27.0	14.0		16.0	16.0		29.0
Total Split (%)	21.8%	35.5%		10.9%	24.5%	12.7%		14.5%	14.5%		26%
Yellow Time (s)	4.0	4.0		4.0	4.0	4.0		4.0	4.0		3.0
All-Red Time (s)	1.0	1.0		1.0	1.0	1.0		1.0	1.0		3.0
Lost Time Adjust (s)	0.0	0.0		0.0	0.0	0.0		0.0	0.0		
Total Lost Time (s)	5.0	5.0		5.0	5.0	5.0		5.0	5.0		
Lead/Lag	Lead	Lag		Lead	Lag						
Lead-Lag Optimize?											
Recall Mode	None	Min		None	C-Min	None		None	None		None

### Intersection Summary

Cycle Length: 110  
 Actuated Cycle Length: 110  
 Offset: 0 (0%), Referenced to phase 2:WBT, Start of Yellow, Master Intersection  
 Natural Cycle: 130  
 Control Type: Actuated-Coordinated

### Splits and Phases: 4: Shopper World Dr/Whittier St & Cochituate Rd



# HCM Signalized Intersection Capacity Analysis

## 5: Burr St & Cochituate Rd

7/9/2013



Movement	EBL	EBT	EBR	WBL	WBT	WBR	NBL	NBT	NBR	SBL	SBT	SBR
Lane Configurations												
Volume (vph)	80	920	20	0	1430	320	10	65	385	455	55	70
Ideal Flow (vphpl)	1900	1900	1900	1900	1900	1900	1900	1900	1900	1900	1900	1900
Total Lost time (s)	5.0	5.0			5.0	5.0		5.0	4.0	5.0	5.0	
Lane Util. Factor	1.00	0.95			0.95	1.00		1.00	1.00	0.95	0.95	
Frt	1.00	1.00			1.00	0.85		1.00	0.85	1.00	0.96	
Flt Protected	0.95	1.00			1.00	1.00		0.99	1.00	0.95	0.97	
Satd. Flow (prot)	1770	3528			3539	1583		1850	1583	1681	1658	
Flt Permitted	0.95	1.00			1.00	1.00		0.99	1.00	0.95	0.97	
Satd. Flow (perm)	1770	3528			3539	1583		1850	1583	1681	1658	
Peak-hour factor, PHF	0.95	0.95	0.95	0.95	0.95	0.95	0.95	0.95	0.95	0.95	0.95	0.95
Adj. Flow (vph)	84	968	21	0	1505	337	11	68	405	479	58	74
RTOR Reduction (vph)	0	1	0	0	0	135	0	0	0	0	10	0
Lane Group Flow (vph)	84	988	0	0	1505	202	0	79	405	307	294	0
Turn Type	Prot	NA			NA	Perm	Split	NA	Free	Split	NA	
Protected Phases	5	2			6		4	4		8	8	
Permitted Phases						6			Free			
Actuated Green, G (s)	10.6	71.9			56.3	56.3		5.6	110.0	17.5	17.5	
Effective Green, g (s)	10.6	71.9			56.3	56.3		5.6	110.0	17.5	17.5	
Actuated g/C Ratio	0.10	0.65			0.51	0.51		0.05	1.00	0.16	0.16	
Clearance Time (s)	5.0	5.0			5.0	5.0		5.0		5.0	5.0	
Vehicle Extension (s)	3.0	3.0			3.0	3.0		3.0		3.0	3.0	
Lane Grp Cap (vph)	170	2306			1811	810		94	1583	267	263	
v/s Ratio Prot	0.05	c0.28			c0.43			c0.04		c0.18	0.18	
v/s Ratio Perm						0.13			0.26			
v/c Ratio	0.49	0.43			0.83	0.25		0.84	0.26	1.15	1.12	
Uniform Delay, d1	47.2	9.2			22.8	15.0		51.8	0.0	46.2	46.2	
Progression Factor	0.91	0.46			1.00	1.00		1.00	1.00	1.00	1.00	
Incremental Delay, d2	1.5	0.4			4.6	0.7		45.8	0.4	101.7	90.8	
Delay (s)	44.5	4.6			27.4	15.8		97.6	0.4	148.0	137.0	
Level of Service	D	A			C	B		F	A	F	F	
Approach Delay (s)		7.7			25.3			16.3			142.5	
Approach LOS		A			C			B			F	

### Intersection Summary

HCM 2000 Control Delay	37.4	HCM 2000 Level of Service	D
HCM 2000 Volume to Capacity ratio	0.86		
Actuated Cycle Length (s)	110.0	Sum of lost time (s)	20.0
Intersection Capacity Utilization	79.9%	ICU Level of Service	D
Analysis Period (min)	15		
c Critical Lane Group			

# Phasings

## 5: Burr St & Cochituate Rd

7/9/2013



Lane Group	EBL	EBT	WBT	WBR	NBT	NBR	SBL	SBT
Lane Configurations								
Volume (vph)	80	920	1430	320	65	385	455	55
Turn Type	Prot	NA	NA	Perm	NA	Free	Split	NA
Protected Phases	5	2	6		4		8	8
Permitted Phases				6		Free		
Detector Phase	5	2	6	6	4		8	8
Switch Phase								
Minimum Initial (s)	6.0	12.0	12.0	12.0	6.0		6.0	6.0
Minimum Split (s)	11.0	17.0	17.0	17.0	11.0		11.0	11.0
Total Split (s)	25.0	79.0	54.0	54.0	12.0		19.0	19.0
Total Split (%)	22.7%	71.8%	49.1%	49.1%	10.9%		17.3%	17.3%
Yellow Time (s)	3.0	3.0	3.0	3.0	3.0		3.0	3.0
All-Red Time (s)	2.0	2.0	2.0	2.0	2.0		2.0	2.0
Lost Time Adjust (s)	0.0	0.0	0.0	0.0	0.0		0.0	0.0
Total Lost Time (s)	5.0	5.0	5.0	5.0	5.0		5.0	5.0
Lead/Lag	Lead		Lag	Lag				
Lead-Lag Optimize?	Yes		Yes	Yes				
Recall Mode	Min	C-Min	C-Min	C-Min	None		None	None

### Intersection Summary

Cycle Length: 110  
 Actuated Cycle Length: 110  
 Offset: 69 (63%), Referenced to phase 2:EBT and 6:WBT, Start of Yellow  
 Natural Cycle: 90  
 Control Type: Actuated-Coordinated

Splits and Phases: 5: Burr St & Cochituate Rd



# HCM Signalized Intersection Capacity Analysis

## 6: Speen St & Cochituate Rd

7/9/2013



Movement	EBL	EBT	EBR	WBL	WBT	WBR	NBL	NBT	NBR	SBL	SBT	SBR
Lane Configurations												
Volume (vph)	80	435	935	305	730	40	750	360	180	95	540	570
Ideal Flow (vphpl)	1900	1900	1900	1900	1900	1900	1900	1900	1900	1900	1900	1900
Total Lost time (s)	5.5	6.0	6.0	5.5	5.5		5.5	6.0		5.5	6.0	6.0
Lane Util. Factor	1.00	0.91	0.91	1.00	0.95		0.97	0.95		1.00	0.95	1.00
Frt	1.00	0.97	0.85	1.00	0.99		1.00	0.95		1.00	1.00	0.85
Flt Protected	0.95	1.00	1.00	0.95	1.00		0.95	1.00		0.95	1.00	1.00
Satd. Flow (prot)	1770	3279	1441	1770	3512		3433	3362		1770	3539	1583
Flt Permitted	0.95	1.00	1.00	0.95	1.00		0.95	1.00		0.95	1.00	1.00
Satd. Flow (perm)	1770	3279	1441	1770	3512		3433	3362		1770	3539	1583
Peak-hour factor, PHF	0.97	0.97	0.97	0.97	0.97	0.97	0.97	0.97	0.97	0.97	0.97	0.97
Adj. Flow (vph)	82	448	964	314	753	41	773	371	186	98	557	588
RTOR Reduction (vph)	0	13	220	0	2	0	0	34	0	0	0	226
Lane Group Flow (vph)	82	560	619	314	792	0	773	523	0	98	557	362
Turn Type	Prot	NA	pt+ov	Prot	NA		Prot	NA		Prot	NA	pt+ov
Protected Phases	5	2	2 7	1	6		7	4		3	8	8 5
Permitted Phases												
Actuated Green, G (s)	13.6	26.3	62.1	30.3	43.5		29.8	45.8		12.4	28.4	42.0
Effective Green, g (s)	13.6	26.3	62.1	30.3	43.5		29.8	45.8		12.4	28.4	42.0
Actuated g/C Ratio	0.09	0.18	0.42	0.20	0.29		0.20	0.31		0.08	0.19	0.28
Clearance Time (s)	5.5	6.0		5.5	5.5		5.5	6.0		5.5	6.0	
Vehicle Extension (s)	3.0	3.0		3.0	3.0		3.0	3.0		3.0	3.0	
Lane Grp Cap (vph)	162	583	605	362	1032		691	1041		148	679	449
v/s Ratio Prot	0.05	0.17	c0.43	c0.18	0.23		c0.23	0.16		0.06	c0.16	0.23
v/s Ratio Perm												
v/c Ratio	0.51	0.96	1.02	0.87	0.77		1.12	0.50		0.66	0.82	0.81
Uniform Delay, d1	64.0	60.3	42.9	56.9	47.6		59.1	41.7		65.7	57.3	49.2
Progression Factor	1.00	1.00	1.00	1.00	1.00		1.00	1.00		1.00	1.00	1.00
Incremental Delay, d2	2.5	27.5	42.4	19.1	3.5		71.7	0.4		10.6	7.9	10.1
Delay (s)	66.4	87.8	85.3	76.0	51.1		130.7	42.1		76.3	65.2	59.3
Level of Service	E	F	F	E	D		F	D		E	E	E
Approach Delay (s)		85.2			58.1			93.6			63.3	
Approach LOS		F			E			F			E	

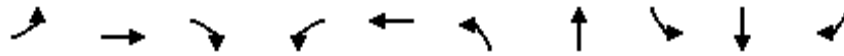
### Intersection Summary

HCM 2000 Control Delay	76.3	HCM 2000 Level of Service	E
HCM 2000 Volume to Capacity ratio	0.96		
Actuated Cycle Length (s)	147.9	Sum of lost time (s)	29.0
Intersection Capacity Utilization	94.4%	ICU Level of Service	F
Analysis Period (min)	15		
c Critical Lane Group			

# Phasings

## 6: Speen St & Cochituate Rd

7/9/2013

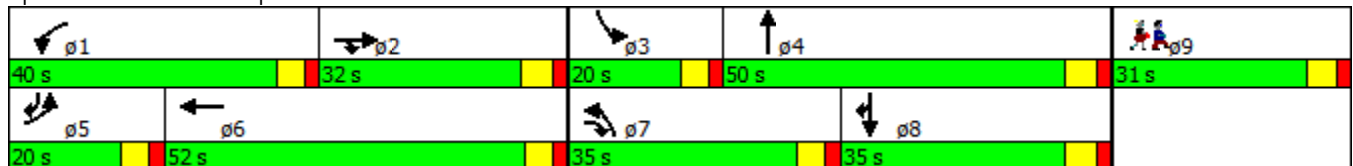


Lane Group	EBL	EBT	EBR	WBL	WBT	NBL	NBT	SBL	SBT	SBR	ø9
Lane Configurations											
Volume (vph)	80	435	935	305	730	750	360	95	540	570	
Turn Type	Prot	NA	pt+ov	Prot	NA	Prot	NA	Prot	NA	pt+ov	
Protected Phases	5	2	2 7	1	6	7	4	3	8	8 5	9
Permitted Phases											
Detector Phase	5	2	2 7	1	6	7	4	3	8	8 5	
Switch Phase											
Minimum Initial (s)	5.0	5.0		5.0	5.0	5.0	5.0	5.0	5.0		1.0
Minimum Split (s)	10.5	12.0		10.5	10.5	10.5	11.0	10.5	11.0		31.0
Total Split (s)	20.0	32.0		40.0	52.0	35.0	50.0	20.0	35.0		31.0
Total Split (%)	11.6%	18.5%		23.1%	30.1%	20.2%	28.9%	11.6%	20.2%		18%
Yellow Time (s)	3.5	4.0		3.5	3.5	3.5	4.0	3.5	4.0		4.0
All-Red Time (s)	2.0	2.0		2.0	2.0	2.0	2.0	2.0	2.0		2.0
Lost Time Adjust (s)	0.0	0.0		0.0	0.0	0.0	0.0	0.0	0.0		0.0
Total Lost Time (s)	5.5	6.0		5.5	5.5	5.5	6.0	5.5	6.0		6.0
Lead/Lag	Lead	Lag		Lead	Lag	Lead	Lag	Lead	Lag		
Lead-Lag Optimize?	Yes	Yes		Yes	Yes	Yes	Yes	Yes	Yes		
Recall Mode	Min	Min		Min	Min	None	None	None	None		None

### Intersection Summary

Cycle Length: 173  
 Actuated Cycle Length: 143.2  
 Natural Cycle: 150  
 Control Type: Actuated-Uncoordinated

### Splits and Phases: 6: Speen St & Cochituate Rd

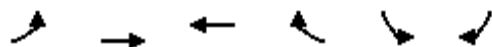




# HCM Signalized Intersection Capacity Analysis

## 7: Cochituate Rd & TJX Driveway

7/9/2013



Movement	EBL	EBT	WBT	WBR	SBL	SBR
Lane Configurations						
Volume (vph)	30	600	500	10	80	500
Ideal Flow (vphpl)	1900	1900	1400	1400	1900	1900
Total Lost time (s)	5.0	5.0	5.0	5.0	5.0	5.0
Lane Util. Factor	1.00	1.00	1.00	1.00	1.00	1.00
Frpb, ped/bikes	1.00	1.00	1.00	1.00	1.00	1.00
Flpb, ped/bikes	1.00	1.00	1.00	1.00	1.00	1.00
Frt	1.00	1.00	1.00	0.85	1.00	0.85
Flt Protected	0.95	1.00	1.00	1.00	0.95	1.00
Satd. Flow (prot)	1770	1863	1373	1167	1770	1583
Flt Permitted	0.28	1.00	1.00	1.00	0.95	1.00
Satd. Flow (perm)	523	1863	1373	1167	1770	1583
Peak-hour factor, PHF	0.95	0.95	0.95	0.95	0.95	0.95
Adj. Flow (vph)	32	632	526	11	84	526
RTOR Reduction (vph)	0	0	0	7	0	0
Lane Group Flow (vph)	32	632	526	4	84	526
Confl. Peds. (#/hr)						2
Turn Type	pm+pt	NA	NA	Perm	NA	pt+ov
Protected Phases	1	6	2		3	3 1
Permitted Phases	6			2		
Actuated Green, G (s)	50.8	50.8	29.4	29.4	6.1	27.5
Effective Green, g (s)	50.8	50.8	29.4	29.4	6.1	27.5
Actuated g/C Ratio	0.68	0.68	0.39	0.39	0.08	0.37
Clearance Time (s)	5.0	5.0	5.0	5.0	5.0	
Vehicle Extension (s)	3.0	3.0	3.0	3.0	3.0	
Lane Grp Cap (vph)	627	1263	538	458	144	581
v/s Ratio Prot	0.01	0.34	c0.38		0.05	c0.33
v/s Ratio Perm	0.02			0.00		
v/c Ratio	0.05	0.50	0.98	0.01	0.58	0.91
Uniform Delay, d1	9.9	5.9	22.4	13.9	33.2	22.5
Progression Factor	1.00	1.00	1.00	1.00	1.00	1.00
Incremental Delay, d2	0.0	0.3	32.8	0.0	5.9	17.6
Delay (s)	10.0	6.2	55.2	13.9	39.1	40.1
Level of Service	A	A	E	B	D	D
Approach Delay (s)		6.4	54.3		39.9	
Approach LOS		A	D		D	

### Intersection Summary

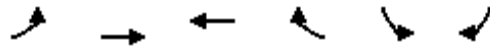
HCM 2000 Control Delay	31.9	HCM 2000 Level of Service	C
HCM 2000 Volume to Capacity ratio	0.98		
Actuated Cycle Length (s)	74.9	Sum of lost time (s)	20.0
Intersection Capacity Utilization	75.2%	ICU Level of Service	D
Analysis Period (min)	15		

c Critical Lane Group

# Phasings

## 7: Cochituate Rd & TJX Driveway

7/9/2013

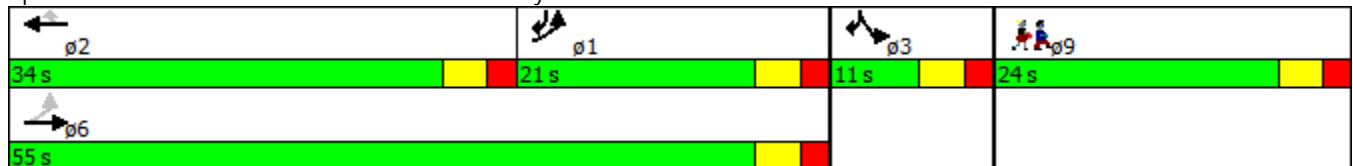


Lane Group	EBL	EBT	WBT	WBR	SBL	SBR	ø9
Lane Configurations							
Volume (vph)	30	600	500	10	80	500	
Turn Type	pm+pt	NA	NA	Perm	NA	pt+ov	
Protected Phases	1	6	2		3	3 1	9
Permitted Phases	6			2			
Detector Phase	1	6	2	2	3	3 1	
Switch Phase							
Minimum Initial (s)	4.0	4.0	4.0	4.0	6.0		4.0
Minimum Split (s)	21.0	20.0	20.0	20.0	11.0		24.0
Total Split (s)	21.0	55.0	34.0	34.0	11.0		24.0
Total Split (%)	23.3%	61.1%	37.8%	37.8%	12.2%		27%
Yellow Time (s)	3.0	3.0	3.0	3.0	3.0		3.0
All-Red Time (s)	2.0	2.0	2.0	2.0	2.0		2.0
Lost Time Adjust (s)	0.0	0.0	0.0	0.0	0.0		
Total Lost Time (s)	5.0	5.0	5.0	5.0	5.0		
Lead/Lag	Lag		Lead	Lead			
Lead-Lag Optimize?	Yes		Yes	Yes			
Recall Mode	None	Min	Min	Min	None		None

### Intersection Summary

Cycle Length: 90  
 Actuated Cycle Length: 70.8  
 Natural Cycle: 110  
 Control Type: Actuated-Uncoordinated

### Splits and Phases: 7: Cochituate Rd & TJX Driveway



**Retimed Conditions: AM Peak Hour**

# HCM Signalized Intersection Capacity Analysis

## 3: Ring Rd/Shoppers World Way & Cochituate Rd

7/9/2013



Movement	EBL	EBT	EBR	WBL	WBT	WBR	NBL	NBT	NBR	SBL	SBT	SBR
Lane Configurations												
Volume (vph)	120	800	65	25	710	85	35	30	25	40	15	100
Ideal Flow (vphpl)	1900	1900	1900	1900	1900	1900	1900	1900	1900	1900	1900	1900
Total Lost time (s)	6.2	6.3	6.3	6.2	6.3	6.3	5.9	5.9		5.9	5.9	5.9
Lane Util. Factor	1.00	0.95	1.00	1.00	0.95	1.00	0.97	1.00		0.95	0.95	1.00
Frt	1.00	1.00	0.85	1.00	1.00	0.85	1.00	0.93		1.00	1.00	0.85
Flt Protected	0.95	1.00	1.00	0.95	1.00	1.00	0.95	1.00		0.95	0.98	1.00
Satd. Flow (prot)	1770	3539	1583	1770	3539	1583	3433	1735		1681	1729	1583
Flt Permitted	0.95	1.00	1.00	0.95	1.00	1.00	0.95	1.00		0.95	0.98	1.00
Satd. Flow (perm)	1770	3539	1583	1770	3539	1583	3433	1735		1681	1729	1583
Peak-hour factor, PHF	0.93	0.93	0.93	0.93	0.93	0.93	0.93	0.93	0.93	0.93	0.93	0.93
Adj. Flow (vph)	129	860	70	27	763	91	38	32	27	43	16	108
RTOR Reduction (vph)	0	0	36	0	0	51	0	25	0	0	0	102
Lane Group Flow (vph)	129	860	34	27	763	40	38	34	0	29	30	6
Turn Type	Prot	NA	pt+ov	Prot	NA	pt+ov	Split	NA		Split	NA	Prot
Protected Phases	1	6	6 8	5	2	2 4	8	8		4	4	4
Permitted Phases												
Actuated Green, G (s)	12.2	34.0	38.8	2.5	24.3	35.4	4.8	4.8		4.8	4.8	4.8
Effective Green, g (s)	12.2	34.0	38.8	2.5	24.3	35.4	4.8	4.8		4.8	4.8	4.8
Actuated g/C Ratio	0.15	0.42	0.48	0.03	0.30	0.44	0.06	0.06		0.06	0.06	0.06
Clearance Time (s)	6.2	6.3		6.2	6.3		5.9	5.9		5.9	5.9	5.9
Vehicle Extension (s)	3.0	3.0		3.0	3.0		3.0	3.0		3.0	3.0	3.0
Lane Grp Cap (vph)	269	1504	767	55	1074	700	205	104		100	103	94
v/s Ratio Prot	c0.07	c0.24	0.02	0.02	c0.22	0.03	0.01	c0.02		0.02	c0.02	0.00
v/s Ratio Perm												
v/c Ratio	0.48	0.57	0.04	0.49	0.71	0.06	0.19	0.32		0.29	0.29	0.07
Uniform Delay, d1	31.0	17.5	10.8	38.1	24.7	12.8	35.7	36.0		36.0	36.0	35.5
Progression Factor	1.50	0.49	1.00	0.58	1.18	1.00	1.00	1.00		1.00	1.00	1.00
Incremental Delay, d2	1.2	1.4	0.0	5.7	3.4	0.0	0.4	1.8		1.6	1.6	0.3
Delay (s)	47.7	9.9	10.9	27.8	32.7	12.8	36.2	37.9		37.6	37.5	35.8
Level of Service	D	A	B	C	C	B	D	D		D	D	D
Approach Delay (s)		14.6			30.5			37.2			36.4	
Approach LOS		B			C			D			D	

### Intersection Summary

HCM 2000 Control Delay	23.6	HCM 2000 Level of Service	C
HCM 2000 Volume to Capacity ratio	0.54		
Actuated Cycle Length (s)	80.0	Sum of lost time (s)	29.3
Intersection Capacity Utilization	49.8%	ICU Level of Service	A
Analysis Period (min)	15		
c Critical Lane Group			

# Phasings

## 3: Ring Rd/Shoppers World Way & Cochituate Rd

7/9/2013

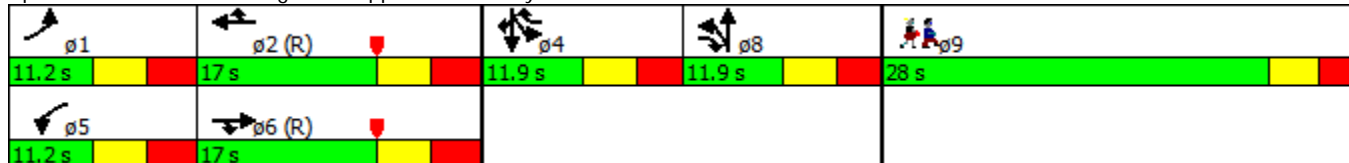


Lane Group	EBL	EBT	EBR	WBL	WBT	WBR	NBL	NBT	SBL	SBT	SBR	ø9
Lane Configurations												
Volume (vph)	120	800	65	25	710	85	35	30	40	15	100	
Turn Type	Prot	NA	pt+ov	Prot	NA	pt+ov	Split	NA	Split	NA	Prot	
Protected Phases	1	6	6 8	5	2	2 4	8	8	4	4	4	9
Permitted Phases												
Detector Phase	1	6	6 8	5	2	2 4	8	8	4	4	4	
Switch Phase												
Minimum Initial (s)	5.0	9.0		5.0	9.0		6.0	6.0	6.0	6.0	6.0	1.0
Minimum Split (s)	11.2	15.3		11.2	16.0		11.9	11.9	11.9	11.9	11.9	28.0
Total Split (s)	11.2	17.0		11.2	17.0		11.9	11.9	11.9	11.9	11.9	28.0
Total Split (%)	14.0%	21.3%		14.0%	21.3%		14.9%	14.9%	14.9%	14.9%	14.9%	35%
Yellow Time (s)	3.2	3.2		3.2	3.2		3.2	3.2	3.2	3.2	3.2	3.0
All-Red Time (s)	3.0	3.1		3.0	3.1		2.7	2.7	2.7	2.7	2.7	2.0
Lost Time Adjust (s)	0.0	0.0		0.0	0.0		0.0	0.0	0.0	0.0	0.0	
Total Lost Time (s)	6.2	6.3		6.2	6.3		5.9	5.9	5.9	5.9	5.9	
Lead/Lag	Lead	Lag		Lead	Lag							
Lead-Lag Optimize?												
Recall Mode	None	C-Min		None	C-Min		None	None	None	None	None	None

### Intersection Summary

Cycle Length: 80  
 Actuated Cycle Length: 80  
 Offset: 51.2 (64%), Referenced to phase 2:WBT and 6:EBT, Start of Yellow  
 Natural Cycle: 90  
 Control Type: Actuated-Coordinated

### Splits and Phases: 3: Ring Rd/Shoppers World Way & Cochituate Rd



# HCM Signalized Intersection Capacity Analysis

## 4: Shopper World Dr/Whittier St & Cochituate Rd

7/9/2013



Movement	EBL	EBT	EBR	WBL	WBT	WBR	NBL	NBT	NBR	SBL	SBT	SBR
Lane Configurations												
Volume (vph)	75	740	55	180	760	115	25	85	20	165	130	40
Ideal Flow (vphpl)	1900	1900	1900	1900	1900	1900	1900	1900	1900	1900	1900	1900
Total Lost time (s)	5.0	5.0	5.0	5.0	5.0			5.0	5.0	5.0	5.0	5.0
Lane Util. Factor	1.00	0.95	0.88	1.00	0.95			0.95	1.00	0.91	0.91	1.00
Frt	1.00	1.00	0.85	1.00	0.98			1.00	0.85	1.00	1.00	0.85
Flt Protected	0.95	1.00	1.00	0.95	1.00			0.99	1.00	0.95	0.98	1.00
Satd. Flow (prot)	1770	3539	2787	1770	3469			3499	1583	1610	3333	1583
Flt Permitted	0.95	1.00	1.00	0.95	1.00			0.99	1.00	0.95	0.98	1.00
Satd. Flow (perm)	1770	3539	2787	1770	3469			3499	1583	1610	3333	1583
Peak-hour factor, PHF	0.93	0.93	0.93	0.93	0.93	0.93	0.93	0.93	0.93	0.93	0.93	0.93
Adj. Flow (vph)	81	796	59	194	817	124	27	91	22	177	140	43
RTOR Reduction (vph)	0	0	40	0	11	0	0	0	16	0	0	36
Lane Group Flow (vph)	81	796	19	194	930	0	0	118	6	103	214	7
Turn Type	Prot	NA	pt+ov	Prot	NA		Split	NA	pt+ov	Split	NA	pt+ov
Protected Phases	1	6	6 8	5	2		8	8	8 5	4	4	4 1
Permitted Phases												
Actuated Green, G (s)	6.3	20.6	26.2	15.6	29.9			5.6	21.2	7.6	7.6	13.9
Effective Green, g (s)	6.3	20.6	26.2	15.6	29.9			5.6	21.2	7.6	7.6	13.9
Actuated g/C Ratio	0.08	0.26	0.33	0.19	0.37			0.07	0.26	0.09	0.09	0.17
Clearance Time (s)	5.0	5.0		5.0	5.0			5.0		5.0	5.0	
Vehicle Extension (s)	2.0	2.0		2.0	2.0			2.0		2.0	2.0	
Lane Grp Cap (vph)	139	911	912	345	1296			244	419	152	316	275
v/s Ratio Prot	0.05	c0.22	0.01	c0.11	c0.27			c0.03	0.00	0.06	c0.06	0.00
v/s Ratio Perm												
v/c Ratio	0.58	0.87	0.02	0.56	0.72			0.48	0.01	0.68	0.68	0.03
Uniform Delay, d1	35.6	28.5	18.2	29.1	21.4			35.8	21.7	35.0	35.0	27.4
Progression Factor	1.42	0.67	1.00	1.52	0.39			1.00	1.00	1.00	1.00	1.00
Incremental Delay, d2	3.7	10.7	0.0	1.1	2.9			0.6	0.0	9.0	4.5	0.0
Delay (s)	54.1	29.7	18.2	45.3	11.3			36.4	21.7	44.1	39.5	27.5
Level of Service	D	C	B	D	B			D	C	D	D	C
Approach Delay (s)		31.1			17.1			34.1			39.4	
Approach LOS		C			B			C			D	

### Intersection Summary

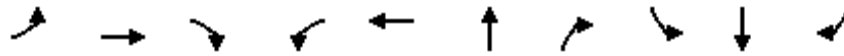
HCM 2000 Control Delay	26.2	HCM 2000 Level of Service	C
HCM 2000 Volume to Capacity ratio	0.66		
Actuated Cycle Length (s)	80.0	Sum of lost time (s)	26.0
Intersection Capacity Utilization	57.7%	ICU Level of Service	B
Analysis Period (min)	15		
c Critical Lane Group			



# Phasings

## 4: Shopper World Dr/Whittier St & Cochituate Rd

7/9/2013



Lane Group	EBL	EBT	EBR	WBL	WBT	NBT	NBR	SBL	SBT	SBR	ø9
Lane Configurations											
Volume (vph)	75	740	55	180	760	85	20	165	130	40	
Turn Type	Prot	NA	pt+ov	Prot	NA	NA	pt+ov	Split	NA	pt+ov	
Protected Phases	1	6	6 8	5	2	8	8 5	4	4	4 1	9
Permitted Phases											
Detector Phase	1	6	6 8	5	2	8	8 5	4	4	4 1	
Switch Phase											
Minimum Initial (s)	6.0	6.0		6.0	6.0	6.0		6.0	6.0		1.0
Minimum Split (s)	11.0	11.0		11.0	11.0	11.0		11.0	11.0		29.0
Total Split (s)	12.0	13.0		12.0	13.0	13.0		13.0	13.0		29.0
Total Split (%)	15.0%	16.3%		15.0%	16.3%	16.3%		16.3%	16.3%		36%
Yellow Time (s)	4.0	4.0		4.0	4.0	4.0		4.0	4.0		3.0
All-Red Time (s)	1.0	1.0		1.0	1.0	1.0		1.0	1.0		3.0
Lost Time Adjust (s)	0.0	0.0		0.0	0.0	0.0		0.0	0.0		
Total Lost Time (s)	5.0	5.0		5.0	5.0	5.0		5.0	5.0		
Lead/Lag	Lead	Lag		Lead	Lag						
Lead-Lag Optimize?	Yes	Yes		Yes	Yes						
Recall Mode	None	C-Max		None	C-Max	None		None	None		None

### Intersection Summary

Cycle Length: 80

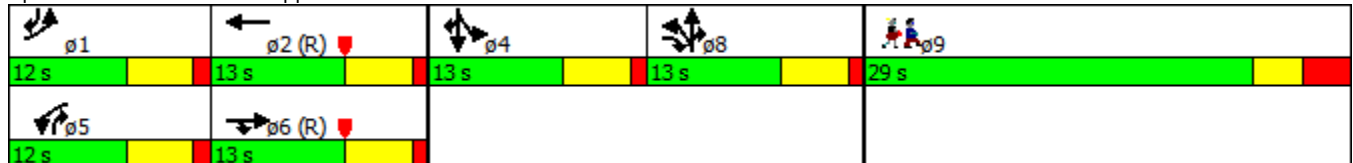
Actuated Cycle Length: 80

Offset: 0 (0%), Referenced to phase 2:WBT and 6:EBT, Start of Yellow, Master Intersection

Natural Cycle: 90

Control Type: Actuated-Coordinated

Splits and Phases: 4: Shopper World Dr/Whittier St & Cochituate Rd



# HCM Signalized Intersection Capacity Analysis

## 5: Burr St & Cochituate Rd

7/9/2013



Movement	EBL	EBT	EBR	WBL	WBT	WBR	NBL	NBT	NBR	SBL	SBT	SBR
Lane Configurations												
Volume (vph)	140	710	5	0	990	1010	5	75	155	80	25	20
Ideal Flow (vphpl)	1900	1900	1900	1900	1900	1900	1900	1900	1900	1900	1900	1900
Total Lost time (s)	5.0	5.0			5.0	5.0		5.0	4.0	5.0	5.0	
Lane Util. Factor	1.00	0.95			0.95	1.00		1.00	1.00	0.95	0.95	
Frt	1.00	1.00			1.00	0.85		1.00	0.85	1.00	0.96	
Flt Protected	0.95	1.00			1.00	1.00		1.00	1.00	0.95	0.98	
Satd. Flow (prot)	1770	3536			3539	1583		1857	1583	1681	1663	
Flt Permitted	0.95	1.00			1.00	1.00		1.00	1.00	0.95	0.98	
Satd. Flow (perm)	1770	3536			3539	1583		1857	1583	1681	1663	
Peak-hour factor, PHF	0.93	0.93	0.93	0.93	0.93	0.93	0.93	0.93	0.93	0.93	0.93	0.93
Adj. Flow (vph)	151	763	5	0	1065	1086	5	81	167	86	27	22
RTOR Reduction (vph)	0	1	0	0	0	272	0	0	0	0	19	0
Lane Group Flow (vph)	151	767	0	0	1065	814	0	86	167	60	56	0
Turn Type	Prot	NA			NA	Perm	Split	NA	Free	Split	NA	
Protected Phases	5	2			6		4	4		8	8	
Permitted Phases						6			Free			
Actuated Green, G (s)	8.3	53.4			40.1	40.1		5.6	80.0	6.0	6.0	
Effective Green, g (s)	8.3	53.4			40.1	40.1		5.6	80.0	6.0	6.0	
Actuated g/C Ratio	0.10	0.67			0.50	0.50		0.07	1.00	0.08	0.08	
Clearance Time (s)	5.0	5.0			5.0	5.0		5.0		5.0	5.0	
Vehicle Extension (s)	3.0	3.0			3.0	3.0		3.0		3.0	3.0	
Lane Grp Cap (vph)	183	2360			1773	793		129	1583	126	124	
v/s Ratio Prot	c0.09	0.22			0.30			c0.05		c0.04	0.03	
v/s Ratio Perm						c0.51			0.11			
v/c Ratio	0.83	0.33			0.60	1.03		0.67	0.11	0.48	0.45	
Uniform Delay, d1	35.1	5.6			14.2	19.9		36.3	0.0	35.5	35.4	
Progression Factor	0.73	1.45			1.00	1.00		1.00	1.00	1.00	1.00	
Incremental Delay, d2	19.7	0.3			1.5	38.8		12.3	0.1	2.8	2.6	
Delay (s)	45.2	8.5			15.8	58.7		48.6	0.1	38.3	38.0	
Level of Service	D	A			B	E		D	A	D	D	
Approach Delay (s)		14.5			37.4			16.6			38.1	
Approach LOS		B			D			B			D	

### Intersection Summary

HCM 2000 Control Delay	29.9	HCM 2000 Level of Service	C
HCM 2000 Volume to Capacity ratio	0.91		
Actuated Cycle Length (s)	80.0	Sum of lost time (s)	20.0
Intersection Capacity Utilization	87.8%	ICU Level of Service	E
Analysis Period (min)	15		
c	Critical Lane Group		

# Phasings

## 5: Burr St & Cochituate Rd

7/9/2013



Lane Group	EBL	EBT	WBT	WBR	NBT	NBR	SBL	SBT
Lane Configurations								
Volume (vph)	140	710	990	1010	75	155	80	25
Turn Type	Prot	NA	NA	Perm	NA	Free	Split	NA
Protected Phases	5	2	6		4		8	8
Permitted Phases				6		Free		
Detector Phase	5	2	6	6	4		8	8
Switch Phase								
Minimum Initial (s)	6.0	12.0	12.0	12.0	6.0		6.0	6.0
Minimum Split (s)	11.0	17.0	17.0	17.0	11.0		11.0	11.0
Total Split (s)	11.0	55.0	44.0	44.0	12.0		13.0	13.0
Total Split (%)	13.8%	68.8%	55.0%	55.0%	15.0%		16.3%	16.3%
Yellow Time (s)	3.0	3.0	3.0	3.0	3.0		3.0	3.0
All-Red Time (s)	2.0	2.0	2.0	2.0	2.0		2.0	2.0
Lost Time Adjust (s)	0.0	0.0	0.0	0.0	0.0		0.0	0.0
Total Lost Time (s)	5.0	5.0	5.0	5.0	5.0		5.0	5.0
Lead/Lag	Lead		Lag	Lag				
Lead-Lag Optimize?	Yes		Yes	Yes				
Recall Mode	None	C-Max	C-Max	C-Max	None		None	None

### Intersection Summary

Cycle Length: 80  
 Actuated Cycle Length: 80  
 Offset: 65 (81%), Referenced to phase 2:EBT and 6:WBT, Start of Yellow  
 Natural Cycle: 90  
 Control Type: Actuated-Coordinated

Splits and Phases: 5: Burr St & Cochituate Rd



# HCM Signalized Intersection Capacity Analysis

## 6: Speen St & Cochituate Rd

7/9/2013



Movement	EBL	EBT	EBR	WBL	WBT	WBR	NBL	NBT	NBR	SBL	SBT	SBR
Lane Configurations												
Volume (vph)	285	920	930	150	320	70	580	495	370	105	335	240
Ideal Flow (vphpl)	1900	1900	1900	1900	1900	1900	1900	1900	1900	1900	1900	1900
Total Lost time (s)	5.5	5.5	5.5	5.5	5.5		5.5	6.0		5.5	6.0	6.0
Lane Util. Factor	1.00	0.91	0.91	1.00	0.95		0.97	0.95		1.00	0.95	1.00
Frbp, ped/bikes	1.00	1.00	1.00	1.00	1.00		1.00	1.00		1.00	1.00	1.00
Flpb, ped/bikes	1.00	1.00	1.00	1.00	1.00		1.00	1.00		1.00	1.00	1.00
Frt	1.00	0.99	0.85	1.00	0.97		1.00	0.94		1.00	1.00	0.85
Flt Protected	0.95	1.00	1.00	0.95	1.00		0.95	1.00		0.95	1.00	1.00
Satd. Flow (prot)	1770	3347	1441	1770	3444		3433	3312		1770	3539	1583
Flt Permitted	0.95	1.00	1.00	0.95	1.00		0.95	1.00		0.95	1.00	1.00
Satd. Flow (perm)	1770	3347	1441	1770	3444		3433	3312		1770	3539	1583
Peak-hour factor, PHF	0.96	0.96	0.96	0.96	0.96	0.96	0.96	0.96	0.96	0.96	0.96	0.96
Adj. Flow (vph)	297	958	969	156	333	73	604	516	385	109	349	250
RTOR Reduction (vph)	0	3	250	0	12	0	0	85	0	0	0	173
Lane Group Flow (vph)	297	1033	641	156	394	0	604	816	0	109	349	77
Confl. Peds. (#/hr)			6									
Turn Type	Prot	NA	pt+ov	Prot	NA		Prot	NA		Prot	NA	pt+ov
Protected Phases	5	2	2 7	1	6		7	4		3	8	8 5
Permitted Phases												
Actuated Green, G (s)	24.5	38.8	71.5	14.4	28.7		27.2	31.3		10.6	14.7	39.2
Effective Green, g (s)	24.5	38.8	71.5	14.4	28.7		27.2	31.3		10.6	14.7	39.2
Actuated g/C Ratio	0.19	0.30	0.56	0.11	0.23		0.21	0.25		0.08	0.12	0.31
Clearance Time (s)	5.5	5.5		5.5	5.5		5.5	6.0		5.5	6.0	
Vehicle Extension (s)	3.0	3.0		3.0	3.0		3.0	3.0		3.0	3.0	
Lane Grp Cap (vph)	340	1020	809	200	776		733	814		147	408	487
v/s Ratio Prot	c0.17	c0.31	c0.44	0.09	0.11		0.18	c0.25		0.06	0.10	0.05
v/s Ratio Perm												
v/c Ratio	0.87	1.01	0.79	0.78	0.51		0.82	1.00		0.74	0.86	0.16
Uniform Delay, d1	49.9	44.2	22.0	54.9	43.1		47.8	48.0		57.0	55.3	32.0
Progression Factor	1.00	1.00	1.00	1.00	1.00		1.00	1.00		1.00	1.00	1.00
Incremental Delay, d2	21.1	31.2	5.3	17.7	0.5		7.5	32.1		18.1	15.9	0.2
Delay (s)	71.0	75.5	27.4	72.6	43.7		55.2	80.1		75.1	71.2	32.2
Level of Service	E	E	C	E	D		E	F		E	E	C
Approach Delay (s)		55.6			51.7			70.1			58.0	
Approach LOS		E			D			E			E	

### Intersection Summary

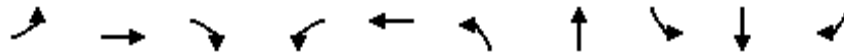
HCM 2000 Control Delay	59.9	HCM 2000 Level of Service	E
HCM 2000 Volume to Capacity ratio	0.99		
Actuated Cycle Length (s)	127.3	Sum of lost time (s)	28.0
Intersection Capacity Utilization	93.9%	ICU Level of Service	F
Analysis Period (min)	15		

c Critical Lane Group

# Phasings

## 6: Speen St & Cochituate Rd

7/9/2013

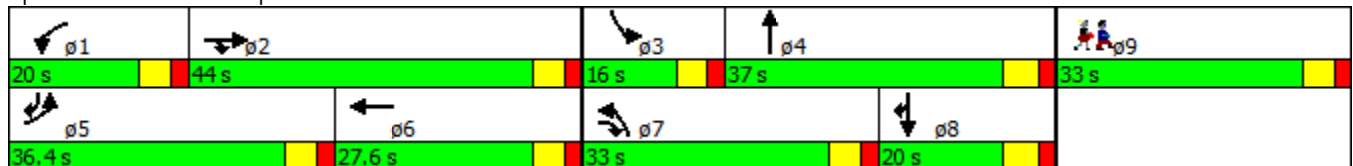


Lane Group	EBL	EBT	EBR	WBL	WBT	NBL	NBT	SBL	SBT	SBR	ø9
Lane Configurations											
Volume (vph)	285	920	930	150	320	580	495	105	335	240	
Turn Type	Prot	NA	pt+ov	Prot	NA	Prot	NA	Prot	NA	pt+ov	
Protected Phases	5	2	2 7	1	6	7	4	3	8	8 5	9
Permitted Phases											
Detector Phase	5	2	2 7	1	6	7	4	3	8	8 5	
Switch Phase											
Minimum Initial (s)	5.0	5.0		5.0	5.0	5.0	5.0	5.0	5.0		5.0
Minimum Split (s)	10.5	11.0		10.5	11.0	10.5	11.0	10.5	11.0		33.0
Total Split (s)	36.4	44.0		20.0	27.6	33.0	37.0	16.0	20.0		33.0
Total Split (%)	24.3%	29.3%		13.3%	18.4%	22.0%	24.7%	10.7%	13.3%		22%
Yellow Time (s)	3.5	3.5		3.5	3.5	3.5	4.0	3.5	4.0		3.5
All-Red Time (s)	2.0	2.0		2.0	2.0	2.0	2.0	2.0	2.0		2.0
Lost Time Adjust (s)	0.0	0.0		0.0	0.0	0.0	0.0	0.0	0.0		0.0
Total Lost Time (s)	5.5	5.5		5.5	5.5	5.5	6.0	5.5	6.0		6.0
Lead/Lag	Lead	Lag		Lead	Lag	Lead	Lag	Lead	Lag		
Lead-Lag Optimize?	Yes	Yes		Yes	Yes		Yes	Yes			
Recall Mode	None	None		None	None	None	None	None	None		None

### Intersection Summary

Cycle Length: 150  
 Actuated Cycle Length: 122.8  
 Natural Cycle: 150  
 Control Type: Actuated-Uncoordinated

Splits and Phases: 6: Speen St & Cochituate Rd



# HCM Signalized Intersection Capacity Analysis

## 7: Cochituate Rd & TJX Driveway

7/9/2013



Movement	EBL	EBT	WBT	WBR	SBL	SBR
Lane Configurations						
Volume (vph)	610	735	480	115	10	20
Ideal Flow (vphpl)	1900	1900	1900	1900	1900	1900
Total Lost time (s)	5.0	5.0	5.0	5.0	5.0	5.0
Lane Util. Factor	1.00	1.00	1.00	1.00	1.00	1.00
Frbp, ped/bikes	1.00	1.00	1.00	1.00	1.00	1.00
Flpb, ped/bikes	1.00	1.00	1.00	1.00	1.00	1.00
Frt	1.00	1.00	1.00	0.85	1.00	0.85
Flt Protected	0.95	1.00	1.00	1.00	0.95	1.00
Satd. Flow (prot)	1770	1863	1863	1583	1770	1583
Flt Permitted	0.23	1.00	1.00	1.00	0.95	1.00
Satd. Flow (perm)	421	1863	1863	1583	1770	1583
Peak-hour factor, PHF	0.92	0.92	0.92	0.92	0.92	0.92
Adj. Flow (vph)	663	799	522	125	11	22
RTOR Reduction (vph)	0	0	0	71	0	12
Lane Group Flow (vph)	663	799	522	54	11	10
Confl. Peds. (#/hr)						2
Turn Type	pm+pt	NA	NA	Perm	NA	pt+ov
Protected Phases	1	6	2		3	3 1
Permitted Phases	6			2		
Actuated Green, G (s)	63.2	63.2	28.3	28.3	2.3	37.2
Effective Green, g (s)	63.2	63.2	28.3	28.3	2.3	37.2
Actuated g/C Ratio	0.76	0.76	0.34	0.34	0.03	0.45
Clearance Time (s)	5.0	5.0	5.0	5.0	5.0	
Vehicle Extension (s)	3.0	3.0	3.0	3.0	3.0	
Lane Grp Cap (vph)	807	1420	635	540	49	710
v/s Ratio Prot	c0.30	0.43	0.28		c0.01	0.01
v/s Ratio Perm	c0.33			0.03		
v/c Ratio	0.82	0.56	0.82	0.10	0.22	0.01
Uniform Delay, d1	15.6	4.1	25.0	18.6	39.4	12.7
Progression Factor	1.00	1.00	1.00	1.00	1.00	1.00
Incremental Delay, d2	6.7	0.5	8.4	0.1	2.3	0.0
Delay (s)	22.3	4.6	33.4	18.7	41.8	12.7
Level of Service	C	A	C	B	D	B
Approach Delay (s)		12.7	30.6		22.4	
Approach LOS		B	C		C	

### Intersection Summary

HCM 2000 Control Delay	18.2	HCM 2000 Level of Service	B
HCM 2000 Volume to Capacity ratio	0.81		
Actuated Cycle Length (s)	82.9	Sum of lost time (s)	20.0
Intersection Capacity Utilization	76.6%	ICU Level of Service	D
Analysis Period (min)	15		

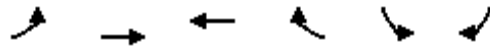
c Critical Lane Group



# Phasings

## 7: Cochituate Rd & TJX Driveway

7/9/2013



Lane Group	EBL	EBT	WBT	WBR	SBL	SBR	ø9
Lane Configurations							
Volume (vph)	610	735	480	115	10	20	
Turn Type	pm+pt	NA	NA	Perm	NA	pt+ov	
Protected Phases	1	6	2		3	3 1	9
Permitted Phases	6			2			
Detector Phase	1	6	2	2	3	3 1	
Switch Phase							
Minimum Initial (s)	4.0	4.0	4.0	4.0	6.0		4.0
Minimum Split (s)	9.0	12.0	21.0	21.0	12.0		21.0
Total Split (s)	34.0	67.0	33.0	33.0	12.0		21.0
Total Split (%)	34.0%	67.0%	33.0%	33.0%	12.0%		21%
Yellow Time (s)	3.0	3.0	3.0	3.0	3.0		3.0
All-Red Time (s)	2.0	2.0	2.0	2.0	2.0		2.0
Lost Time Adjust (s)	0.0	0.0	0.0	0.0	0.0		
Total Lost Time (s)	5.0	5.0	5.0	5.0	5.0		
Lead/Lag	Lag		Lead	Lead			
Lead-Lag Optimize?	Yes		Yes	Yes			
Recall Mode	None	Min	Min	Min	None		None

### Intersection Summary

Cycle Length: 100  
 Actuated Cycle Length: 75.5  
 Natural Cycle: 100  
 Control Type: Actuated-Uncoordinated

### Splits and Phases: 7: Cochituate Rd & TJX Driveway

ø2	ø1	ø3	ø9
33 s	34 s	12 s	21 s
ø6			
67 s			

## **Retimed Conditions: PM Peak Hour**

# HCM Signalized Intersection Capacity Analysis

## 3: Ring Rd/Shoppers World Way & Cochituate Rd

7/9/2013



Movement	EBL	EBT	EBR	WBL	WBT	WBR	NBL	NBT	NBR	SBL	SBT	SBR
Lane Configurations												
Volume (vph)	150	625	130	65	920	140	180	115	45	95	65	190
Ideal Flow (vphpl)	1900	1900	1900	1900	1900	1900	1900	1900	1900	1900	1900	1900
Total Lost time (s)	6.2	6.3	6.3	5.9	6.3	6.3	5.9	5.9		5.9	5.9	5.9
Lane Util. Factor	1.00	0.95	1.00	1.00	0.95	1.00	0.97	1.00		0.95	0.95	1.00
Frt	1.00	1.00	0.85	1.00	1.00	0.85	1.00	0.96		1.00	1.00	0.85
Flt Protected	0.95	1.00	1.00	0.95	1.00	1.00	0.95	1.00		0.95	0.99	1.00
Satd. Flow (prot)	1770	3539	1583	1770	3539	1583	3433	1785		1681	1751	1583
Flt Permitted	0.95	1.00	1.00	0.95	1.00	1.00	0.95	1.00		0.95	0.99	1.00
Satd. Flow (perm)	1770	3539	1583	1770	3539	1583	3433	1785		1681	1751	1583
Peak-hour factor, PHF	0.95	0.95	0.95	0.95	0.95	0.95	0.95	0.95	0.95	0.95	0.95	0.95
Adj. Flow (vph)	158	658	137	68	968	147	189	121	47	100	68	200
RTOR Reduction (vph)	0	0	62	0	0	77	0	0	0	0	0	148
Lane Group Flow (vph)	158	658	75	68	968	70	189	168	0	82	86	52
Turn Type	Prot	NA	pt+ov	Prot	NA	pt+ov	Split	NA		Split	NA	pt+ov
Protected Phases	1	6	6 8	5	2	2 4	8	8		4	4	4 1
Permitted Phases												
Actuated Green, G (s)	20.1	50.5	60.5	7.5	37.6	52.3	10.0	10.0		8.4	8.4	28.5
Effective Green, g (s)	20.1	50.5	60.5	7.5	37.6	52.3	10.0	10.0		8.4	8.4	28.5
Actuated g/C Ratio	0.18	0.46	0.55	0.07	0.34	0.48	0.09	0.09		0.08	0.08	0.26
Clearance Time (s)	6.2	6.3		5.9	6.3		5.9	5.9		5.9	5.9	
Vehicle Extension (s)	3.0	3.0		3.0	3.0		3.0	3.0		3.0	3.0	
Lane Grp Cap (vph)	323	1624	870	120	1209	752	312	162		128	133	410
v/s Ratio Prot	c0.09	0.19	0.05	0.04	c0.27	0.04	0.06	c0.09		0.05	c0.05	0.03
v/s Ratio Perm												
v/c Ratio	0.49	0.41	0.09	0.57	0.80	0.09	0.61	1.04		0.64	0.65	0.13
Uniform Delay, d1	40.3	19.8	11.7	49.7	32.8	15.8	48.1	50.0		49.3	49.4	31.2
Progression Factor	0.80	0.78	2.14	0.67	1.47	5.40	1.00	1.00		1.00	1.00	1.00
Incremental Delay, d2	1.0	0.7	0.0	3.9	3.7	0.0	3.3	80.8		10.5	10.3	0.1
Delay (s)	33.4	16.1	25.0	37.4	51.9	85.6	51.4	130.8		59.8	59.7	31.4
Level of Service	C	B	C	D	D	F	D	F		E	E	C
Approach Delay (s)		20.3			55.3			88.8			44.3	
Approach LOS		C			E			F			D	

### Intersection Summary

HCM 2000 Control Delay	46.4	HCM 2000 Level of Service	D
HCM 2000 Volume to Capacity ratio	0.69		
Actuated Cycle Length (s)	110.0	Sum of lost time (s)	29.3
Intersection Capacity Utilization	67.8%	ICU Level of Service	C
Analysis Period (min)	15		
c Critical Lane Group			

# Phasings

## 3: Ring Rd/Shoppers World Way & Cochituate Rd

7/9/2013

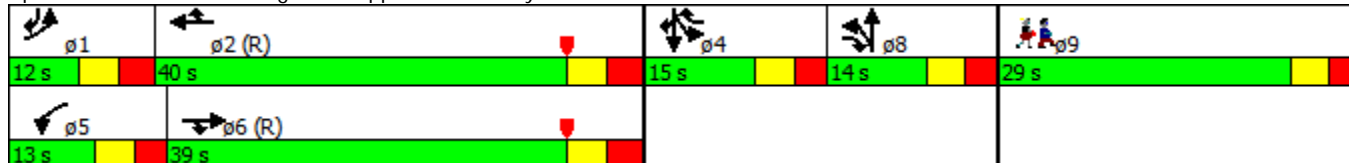


Lane Group	EBL	EBT	EBR	WBL	WBT	WBR	NBL	NBT	SBL	SBT	SBR	ø9
Lane Configurations												
Volume (vph)	150	625	130	65	920	140	180	115	95	65	190	
Turn Type	Prot	NA	pt+ov	Prot	NA	pt+ov	Split	NA	Split	NA	pt+ov	
Protected Phases	1	6	6 8	5	2	2 4	8	8	4	4	4 1	9
Permitted Phases												
Detector Phase	1	6	6 8	5	2	2 4	8	8	4	4	4 1	
Switch Phase												
Minimum Initial (s)	5.0	9.0		5.0	9.0		6.0	6.0	6.0	6.0		1.0
Minimum Split (s)	11.2	15.3		11.2	15.3		11.9	11.9	11.9	11.9		29.0
Total Split (s)	12.0	39.0		13.0	40.0		14.0	14.0	15.0	15.0		29.0
Total Split (%)	10.9%	35.5%		11.8%	36.4%		12.7%	12.7%	13.6%	13.6%		26%
Yellow Time (s)	3.2	3.2		3.2	3.2		3.2	3.2	3.2	3.2		3.0
All-Red Time (s)	3.0	3.1		2.7	3.1		2.7	2.7	2.7	2.7		2.0
Lost Time Adjust (s)	0.0	0.0		0.0	0.0		0.0	0.0	0.0	0.0		
Total Lost Time (s)	6.2	6.3		5.9	6.3		5.9	5.9	5.9	5.9		
Lead/Lag	Lead	Lag		Lead	Lag							
Lead-Lag Optimize?	Yes	Yes		Yes	Yes							
Recall Mode	None	C-Min		None	C-Min		None	None	None	None		None

### Intersection Summary

Cycle Length: 110  
 Actuated Cycle Length: 110  
 Offset: 83 (75%), Referenced to phase 2:WBT and 6:EBT, Start of Yellow  
 Natural Cycle: 110  
 Control Type: Actuated-Coordinated

### Splits and Phases: 3: Ring Rd/Shoppers World Way & Cochituate Rd



# HCM Signalized Intersection Capacity Analysis

## 4: Shopper World Dr/Whittier St & Cochrane Rd

7/9/2013



Movement	EBL	EBT	EBR	WBL	WBT	WBR	NBL	NBT	NBR	SBL	SBT	SBR
Lane Configurations												
Volume (vph)	60	595	110	325	940	200	105	230	115	295	350	95
Ideal Flow (vphpl)	1900	1900	1900	1900	1900	1900	1900	1900	1900	1900	1900	1900
Total Lost time (s)	5.0	5.0	5.0	5.0	5.0			5.0	5.0	5.0	5.0	5.0
Lane Util. Factor	1.00	0.95	0.88	1.00	0.95			0.95	1.00	0.91	0.91	1.00
Frt	1.00	1.00	0.85	1.00	0.97			1.00	0.85	1.00	1.00	0.85
Flt Protected	0.95	1.00	1.00	0.95	1.00			0.98	1.00	0.95	0.99	1.00
Satd. Flow (prot)	1770	3539	2787	1770	3446			3484	1583	1610	3357	1583
Flt Permitted	0.95	1.00	1.00	0.95	1.00			0.98	1.00	0.95	0.99	1.00
Satd. Flow (perm)	1770	3539	2787	1770	3446			3484	1583	1610	3357	1583
Peak-hour factor, PHF	0.95	0.95	0.95	0.95	0.95	0.95	0.95	0.95	0.95	0.95	0.95	0.95
Adj. Flow (vph)	63	626	116	342	989	211	111	242	121	311	368	100
RTOR Reduction (vph)	0	0	0	0	0	0	0	0	0	0	0	78
Lane Group Flow (vph)	63	626	116	342	1200	0	0	353	121	221	458	22
Turn Type	Prot	NA	pt+ov	Prot	NA		Split	NA	pt+ov	Split	NA	pt+ov
Protected Phases	1	6	6 8	5	2		8	8	8 5	4	4	4 1
Permitted Phases												
Actuated Green, G (s)	7.7	22.6	33.6	29.8	44.7			11.0	40.8	16.0	16.0	23.7
Effective Green, g (s)	7.7	22.6	33.6	29.8	44.7			11.0	40.8	16.0	16.0	23.7
Actuated g/C Ratio	0.07	0.21	0.31	0.27	0.41			0.10	0.37	0.15	0.15	0.22
Clearance Time (s)	5.0	5.0		5.0	5.0			5.0		5.0	5.0	
Vehicle Extension (s)	2.0	2.0		2.0	2.0			2.0		2.0	2.0	
Lane Grp Cap (vph)	123	727	851	479	1400			348	587	234	488	341
v/s Ratio Prot	0.04	0.18	0.04	c0.19	c0.35			c0.10	0.08	c0.14	0.14	0.01
v/s Ratio Perm												
v/c Ratio	0.51	0.86	0.14	0.71	0.86			1.01	0.21	0.94	0.94	0.06
Uniform Delay, d1	49.3	42.2	27.7	36.2	29.7			49.5	23.6	46.6	46.5	34.3
Progression Factor	1.40	0.94	1.23	1.48	0.34			1.00	1.00	1.00	1.00	1.00
Incremental Delay, d2	1.4	11.8	0.0	1.6	2.8			51.9	0.1	42.9	25.6	0.0
Delay (s)	70.7	51.7	34.0	55.4	13.0			101.4	23.6	89.5	72.1	34.3
Level of Service	E	D	C	E	B			F	C	F	E	C
Approach Delay (s)		50.6			22.4			81.6			72.2	
Approach LOS		D			C			F			E	

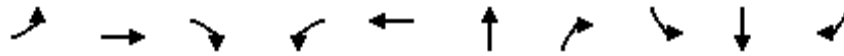
### Intersection Summary

HCM 2000 Control Delay	47.3	HCM 2000 Level of Service	D
HCM 2000 Volume to Capacity ratio	0.86		
Actuated Cycle Length (s)	110.0	Sum of lost time (s)	26.0
Intersection Capacity Utilization	75.6%	ICU Level of Service	D
Analysis Period (min)	15		
c Critical Lane Group			

# Phasings

## 4: Shopper World Dr/Whittier St & Cochituate Rd

7/9/2013

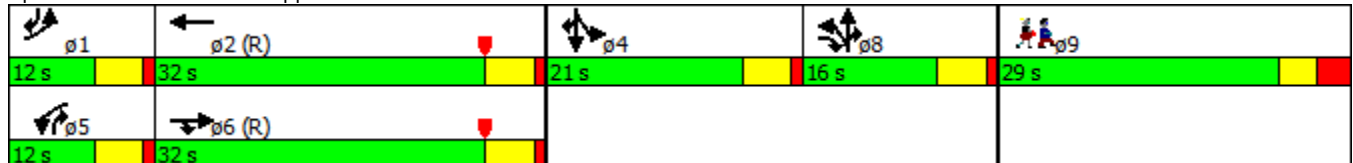


Lane Group	EBL	EBT	EBR	WBL	WBT	NBT	NBR	SBL	SBT	SBR	ø9
Lane Configurations											
Volume (vph)	60	595	110	325	940	230	115	295	350	95	
Turn Type	Prot	NA	pt+ov	Prot	NA	NA	pt+ov	Split	NA	pt+ov	
Protected Phases	1	6	6 8	5	2	8	8 5	4	4	4 1	9
Permitted Phases											
Detector Phase	1	6	6 8	5	2	8	8 5	4	4	4 1	
Switch Phase											
Minimum Initial (s)	6.0	6.0		6.0	6.0	6.0		6.0	6.0		1.0
Minimum Split (s)	12.0	11.0		11.0	12.0	11.0		11.0	11.0		29.0
Total Split (s)	12.0	32.0		12.0	32.0	16.0		21.0	21.0		29.0
Total Split (%)	10.9%	29.1%		10.9%	29.1%	14.5%		19.1%	19.1%		26%
Yellow Time (s)	4.0	4.0		4.0	4.0	4.0		4.0	4.0		3.0
All-Red Time (s)	1.0	1.0		1.0	1.0	1.0		1.0	1.0		3.0
Lost Time Adjust (s)	0.0	0.0		0.0	0.0	0.0		0.0	0.0		
Total Lost Time (s)	5.0	5.0		5.0	5.0	5.0		5.0	5.0		
Lead/Lag	Lead	Lag		Lead	Lag						
Lead-Lag Optimize?											
Recall Mode	None	C-Max		None	C-Max	None		None	None		None

### Intersection Summary

Cycle Length: 110  
 Actuated Cycle Length: 110  
 Offset: 0 (0%), Referenced to phase 2:WBT and 6:EBT, Start of Yellow, Master Intersection  
 Natural Cycle: 130  
 Control Type: Actuated-Coordinated

### Splits and Phases: 4: Shopper World Dr/Whittier St & Cochituate Rd





# HCM Signalized Intersection Capacity Analysis

## 5: Burr St & Cochituate Rd

7/9/2013



Movement	EBL	EBT	EBR	WBL	WBT	WBR	NBL	NBT	NBR	SBL	SBT	SBR
Lane Configurations												
Volume (vph)	80	920	20	0	1430	320	10	65	385	455	55	70
Ideal Flow (vphpl)	1900	1900	1900	1900	1900	1900	1900	1900	1900	1900	1900	1900
Total Lost time (s)	5.0	5.0			5.0	5.0		5.0	4.0	5.0	5.0	
Lane Util. Factor	1.00	0.95			0.95	1.00		1.00	1.00	0.95	0.95	
Frt	1.00	1.00			1.00	0.85		1.00	0.85	1.00	0.96	
Flt Protected	0.95	1.00			1.00	1.00		0.99	1.00	0.95	0.97	
Satd. Flow (prot)	1770	3528			3539	1583		1850	1583	1681	1658	
Flt Permitted	0.95	1.00			1.00	1.00		0.99	1.00	0.95	0.97	
Satd. Flow (perm)	1770	3528			3539	1583		1850	1583	1681	1658	
Peak-hour factor, PHF	0.95	0.95	0.95	0.95	0.95	0.95	0.95	0.95	0.95	0.95	0.95	0.95
Adj. Flow (vph)	84	968	21	0	1505	337	11	68	405	479	58	74
RTOR Reduction (vph)	0	1	0	0	0	151	0	0	0	0	10	0
Lane Group Flow (vph)	84	988	0	0	1505	186	0	79	405	307	294	0
Turn Type	Prot	NA			NA	Perm	Split	NA	Free	Split	NA	
Protected Phases	5	2			6		4	4		8	8	
Permitted Phases						6			Free			
Actuated Green, G (s)	7.1	61.2			49.1	49.1		8.4	110.0	25.4	25.4	
Effective Green, g (s)	7.1	61.2			49.1	49.1		8.4	110.0	25.4	25.4	
Actuated g/C Ratio	0.06	0.56			0.45	0.45		0.08	1.00	0.23	0.23	
Clearance Time (s)	5.0	5.0			5.0	5.0		5.0		5.0	5.0	
Vehicle Extension (s)	3.0	3.0			3.0	3.0		3.0		3.0	3.0	
Lane Grp Cap (vph)	114	1962			1579	706		141	1583	388	382	
v/s Ratio Prot	c0.05	0.28			c0.43			c0.04		c0.18	0.18	
v/s Ratio Perm						0.12			0.26			
v/c Ratio	0.74	0.50			0.95	0.26		0.56	0.26	0.79	0.77	
Uniform Delay, d1	50.5	15.0			29.3	19.1		49.0	0.0	39.8	39.6	
Progression Factor	0.73	1.73			1.00	1.00		1.00	1.00	1.00	1.00	
Incremental Delay, d2	15.7	0.6			14.0	0.9		5.0	0.4	10.5	9.0	
Delay (s)	52.5	26.7			43.3	20.0		54.0	0.4	50.3	48.6	
Level of Service	D	C			D	C		D	A	D	D	
Approach Delay (s)		28.7			39.0			9.1			49.5	
Approach LOS		C			D			A			D	

### Intersection Summary

HCM 2000 Control Delay	34.3	HCM 2000 Level of Service	C
HCM 2000 Volume to Capacity ratio	0.85		
Actuated Cycle Length (s)	110.0	Sum of lost time (s)	20.0
Intersection Capacity Utilization	79.9%	ICU Level of Service	D
Analysis Period (min)	15		
c Critical Lane Group			

# Phasings

## 5: Burr St & Cochituate Rd

7/9/2013

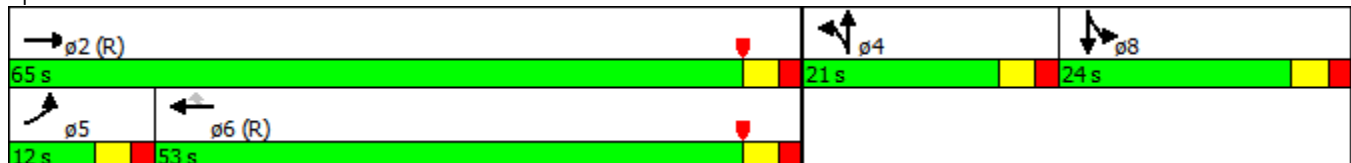


Lane Group	EBL	EBT	WBT	WBR	NBT	NBR	SBL	SBT
Lane Configurations								
Volume (vph)	80	920	1430	320	65	385	455	55
Turn Type	Prot	NA	NA	Perm	NA	Free	Split	NA
Protected Phases	5	2	6		4		8	8
Permitted Phases				6		Free		
Detector Phase	5	2	6	6	4		8	8
Switch Phase								
Minimum Initial (s)	6.0	12.0	12.0	12.0	6.0		6.0	6.0
Minimum Split (s)	11.0	17.0	17.0	17.0	11.0		12.0	12.0
Total Split (s)	12.0	65.0	53.0	53.0	21.0		24.0	24.0
Total Split (%)	10.9%	59.1%	48.2%	48.2%	19.1%		21.8%	21.8%
Yellow Time (s)	3.0	3.0	3.0	3.0	3.0		3.0	3.0
All-Red Time (s)	2.0	2.0	2.0	2.0	2.0		2.0	2.0
Lost Time Adjust (s)	0.0	0.0	0.0	0.0	0.0		0.0	0.0
Total Lost Time (s)	5.0	5.0	5.0	5.0	5.0		5.0	5.0
Lead/Lag	Lead		Lag	Lag				
Lead-Lag Optimize?	Yes		Yes	Yes				
Recall Mode	Min	C-Min	C-Min	C-Min	None		None	None

### Intersection Summary

Cycle Length: 110  
 Actuated Cycle Length: 110  
 Offset: 92 (84%), Referenced to phase 2:EBT and 6:WBT, Start of Yellow  
 Natural Cycle: 90  
 Control Type: Actuated-Coordinated

Splits and Phases: 5: Burr St & Cochituate Rd



# HCM Signalized Intersection Capacity Analysis

## 6: Speen St & Cochituate Rd

7/9/2013



Movement	EBL	EBT	EBR	WBL	WBT	WBR	NBL	NBT	NBR	SBL	SBT	SBR
Lane Configurations												
Volume (vph)	80	435	935	305	730	40	750	360	180	95	540	570
Ideal Flow (vphpl)	1900	1900	1900	1900	1900	1900	1900	1900	1900	1900	1900	1900
Total Lost time (s)	5.5	6.0	6.0	5.5	5.5		5.5	6.0		5.5	6.0	6.0
Lane Util. Factor	1.00	0.91	0.91	1.00	0.95		0.97	0.95		1.00	0.95	1.00
Frt	1.00	0.97	0.85	1.00	0.99		1.00	0.95		1.00	1.00	0.85
Flt Protected	0.95	1.00	1.00	0.95	1.00		0.95	1.00		0.95	1.00	1.00
Satd. Flow (prot)	1770	3300	1441	1770	3512		3433	3362		1770	3539	1583
Flt Permitted	0.95	1.00	1.00	0.95	1.00		0.95	1.00		0.95	1.00	1.00
Satd. Flow (perm)	1770	3300	1441	1770	3512		3433	3362		1770	3539	1583
Peak-hour factor, PHF	0.97	0.97	0.97	0.97	0.97	0.97	0.97	0.97	0.97	0.97	0.97	0.97
Adj. Flow (vph)	82	448	964	314	753	41	773	371	186	98	557	588
RTOR Reduction (vph)	0	11	251	0	3	0	0	39	0	0	0	270
Lane Group Flow (vph)	82	533	617	314	791	0	773	518	0	98	557	318
Turn Type	Prot	NA	pt+ov	Prot	NA		Prot	NA		Prot	NA	pt+ov
Protected Phases	5	2	2 7	1	6		7	4		3	8	8 5
Permitted Phases												
Actuated Green, G (s)	9.6	25.2	57.9	24.7	40.8		26.7	35.3		11.6	20.2	29.8
Effective Green, g (s)	9.6	25.2	57.9	24.7	40.8		26.7	35.3		11.6	20.2	29.8
Actuated g/C Ratio	0.07	0.19	0.45	0.19	0.31		0.21	0.27		0.09	0.16	0.23
Clearance Time (s)	5.5	6.0		5.5	5.5		5.5	6.0		5.5	6.0	
Vehicle Extension (s)	3.0	3.0		3.0	3.0		3.0	3.0		3.0	3.0	
Lane Grp Cap (vph)	130	639	641	336	1102		705	912		157	549	362
v/s Ratio Prot	0.05	0.16	c0.43	c0.18	0.23		c0.23	0.15		0.06	c0.16	0.20
v/s Ratio Perm												
v/c Ratio	0.63	0.83	0.96	0.93	0.72		1.10	0.57		0.62	1.01	0.88
Uniform Delay, d1	58.5	50.4	35.0	51.9	39.5		51.6	40.8		57.1	54.9	48.4
Progression Factor	1.00	1.00	1.00	1.00	1.00		1.00	1.00		1.00	1.00	1.00
Incremental Delay, d2	9.6	9.2	26.4	32.4	2.3		63.3	0.8		7.5	42.1	20.7
Delay (s)	68.1	59.5	61.5	84.2	41.8		115.0	41.6		64.6	97.0	69.1
Level of Service	E	E	E	F	D		F	D		E	F	E
Approach Delay (s)		61.1			53.8			84.2			81.2	
Approach LOS		E			D			F			F	

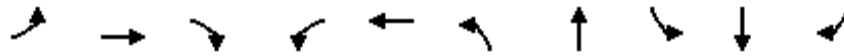
### Intersection Summary

HCM 2000 Control Delay	70.3	HCM 2000 Level of Service	E
HCM 2000 Volume to Capacity ratio	1.00		
Actuated Cycle Length (s)	130.0	Sum of lost time (s)	29.0
Intersection Capacity Utilization	94.4%	ICU Level of Service	F
Analysis Period (min)	15		
c Critical Lane Group			

# Phasings

## 6: Speen St & Cochituate Rd

7/9/2013

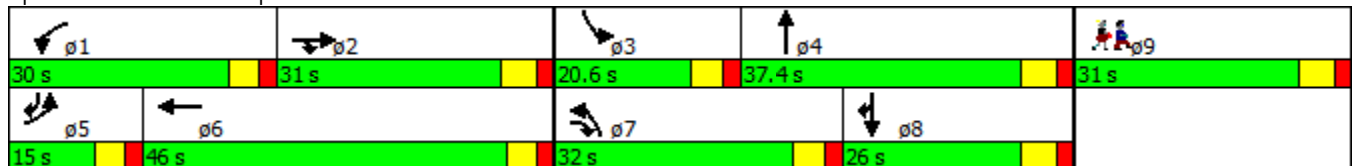


Lane Group	EBL	EBT	EBR	WBL	WBT	NBL	NBT	SBL	SBT	SBR	ø9
Lane Configurations											
Volume (vph)	80	435	935	305	730	750	360	95	540	570	
Turn Type	Prot	NA	pt+ov	Prot	NA	Prot	NA	Prot	NA	pt+ov	
Protected Phases	5	2	2 7	1	6	7	4	3	8	8 5	9
Permitted Phases											
Detector Phase	5	2	2 7	1	6	7	4	3	8	8 5	
Switch Phase											
Minimum Initial (s)	5.0	5.0		5.0	5.0	5.0	5.0	5.0	5.0		1.0
Minimum Split (s)	10.5	12.0		10.5	10.5	10.5	11.0	10.5	11.0		31.0
Total Split (s)	15.0	31.0		30.0	46.0	32.0	37.4	20.6	26.0		31.0
Total Split (%)	10.0%	20.7%		20.0%	30.7%	21.3%	24.9%	13.7%	17.3%		21%
Yellow Time (s)	3.5	4.0		3.5	3.5	3.5	4.0	3.5	4.0		4.0
All-Red Time (s)	2.0	2.0		2.0	2.0	2.0	2.0	2.0	2.0		2.0
Lost Time Adjust (s)	0.0	0.0		0.0	0.0	0.0	0.0	0.0	0.0		0.0
Total Lost Time (s)	5.5	6.0		5.5	5.5	5.5	6.0	5.5	6.0		6.0
Lead/Lag	Lead	Lag		Lead	Lag	Lead	Lag	Lead	Lag		
Lead-Lag Optimize?	Yes	Yes		Yes	Yes	Yes	Yes	Yes	Yes		
Recall Mode	Min	Min		Min	Min	None	None	None	None		None

### Intersection Summary

Cycle Length: 150  
 Actuated Cycle Length: 125.2  
 Natural Cycle: 150  
 Control Type: Actuated-Uncoordinated

### Splits and Phases: 6: Speen St & Cochituate Rd



# HCM Signalized Intersection Capacity Analysis

## 7: Cochituate Rd & TJX Driveway

7/9/2013



Movement	EBL	EBT	WBT	WBR	SBL	SBR
Lane Configurations						
Volume (vph)	30	600	500	10	80	500
Ideal Flow (vphpl)	1900	1900	1400	1400	1900	1900
Total Lost time (s)	5.0	5.0	5.0	5.0	5.0	5.0
Lane Util. Factor	1.00	1.00	1.00	1.00	1.00	1.00
Frpb, ped/bikes	1.00	1.00	1.00	1.00	1.00	1.00
Flpb, ped/bikes	1.00	1.00	1.00	1.00	1.00	1.00
Frt	1.00	1.00	1.00	0.85	1.00	0.85
Flt Protected	0.95	1.00	1.00	1.00	0.95	1.00
Satd. Flow (prot)	1770	1863	1373	1167	1770	1583
Flt Permitted	0.28	1.00	1.00	1.00	0.95	1.00
Satd. Flow (perm)	523	1863	1373	1167	1770	1583
Peak-hour factor, PHF	0.95	0.95	0.95	0.95	0.95	0.95
Adj. Flow (vph)	32	632	526	11	84	526
RTOR Reduction (vph)	0	0	0	7	0	0
Lane Group Flow (vph)	32	632	526	4	84	526
Confl. Peds. (#/hr)						2
Turn Type	pm+pt	NA	NA	Perm	NA	pt+ov
Protected Phases	1	6	2		3	3 1
Permitted Phases	6			2		
Actuated Green, G (s)	50.8	50.8	29.4	29.4	6.1	27.5
Effective Green, g (s)	50.8	50.8	29.4	29.4	6.1	27.5
Actuated g/C Ratio	0.68	0.68	0.39	0.39	0.08	0.37
Clearance Time (s)	5.0	5.0	5.0	5.0	5.0	
Vehicle Extension (s)	3.0	3.0	3.0	3.0	3.0	
Lane Grp Cap (vph)	627	1263	538	458	144	581
v/s Ratio Prot	0.01	0.34	c0.38		0.05	c0.33
v/s Ratio Perm	0.02			0.00		
v/c Ratio	0.05	0.50	0.98	0.01	0.58	0.91
Uniform Delay, d1	9.9	5.9	22.4	13.9	33.2	22.5
Progression Factor	1.00	1.00	1.00	1.00	1.00	1.00
Incremental Delay, d2	0.0	0.3	32.8	0.0	5.9	17.6
Delay (s)	10.0	6.2	55.2	13.9	39.1	40.1
Level of Service	A	A	E	B	D	D
Approach Delay (s)		6.4	54.3		39.9	
Approach LOS		A	D		D	

### Intersection Summary

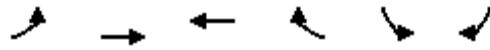
HCM 2000 Control Delay	31.9	HCM 2000 Level of Service	C
HCM 2000 Volume to Capacity ratio	0.98		
Actuated Cycle Length (s)	74.9	Sum of lost time (s)	20.0
Intersection Capacity Utilization	75.2%	ICU Level of Service	D
Analysis Period (min)	15		

c Critical Lane Group

# Phasings

## 7: Cochituate Rd & TJX Driveway

7/9/2013

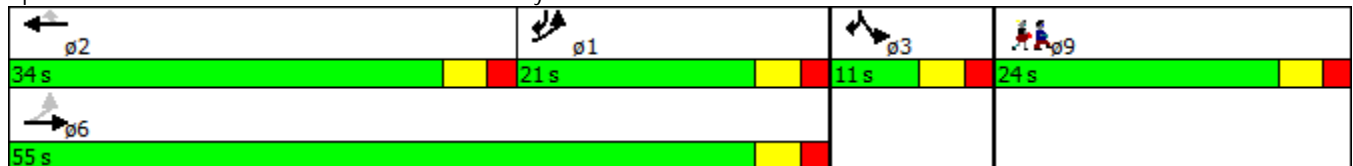


Lane Group	EBL	EBT	WBT	WBR	SBL	SBR	ø9
Lane Configurations							
Volume (vph)	30	600	500	10	80	500	
Turn Type	pm+pt	NA	NA	Perm	NA	pt+ov	
Protected Phases	1	6	2		3	3 1	9
Permitted Phases	6			2			
Detector Phase	1	6	2	2	3	3 1	
Switch Phase							
Minimum Initial (s)	4.0	4.0	4.0	4.0	6.0		4.0
Minimum Split (s)	12.0	12.0	12.0	12.0	11.0		24.0
Total Split (s)	21.0	55.0	34.0	34.0	11.0		24.0
Total Split (%)	23.3%	61.1%	37.8%	37.8%	12.2%		27%
Yellow Time (s)	3.0	3.0	3.0	3.0	3.0		3.0
All-Red Time (s)	2.0	2.0	2.0	2.0	2.0		2.0
Lost Time Adjust (s)	0.0	0.0	0.0	0.0	0.0		
Total Lost Time (s)	5.0	5.0	5.0	5.0	5.0		
Lead/Lag	Lag		Lead	Lead			
Lead-Lag Optimize?	Yes		Yes	Yes			
Recall Mode	None	Min	Min	Min	None		None

### Intersection Summary

Cycle Length: 90  
 Actuated Cycle Length: 70.8  
 Natural Cycle: 110  
 Control Type: Actuated-Uncoordinated

### Splits and Phases: 7: Cochituate Rd & TJX Driveway





**Route 30 Westbound, Third Lane  
from TJX Driveway to the MassPike  
On-Ramp**

---

6: Speen St & Cochituate Rd Performance by approach

---

Approach	EB	WB	NB	SB	All
Denied Del/Veh (s)	0.0	0.0	0.9	0.0	0.3
Total Del/Veh (s)	26.8	42.4	75.6	45.7	49.4

Queuing and Blocking Report  
 3rd Lane on Route 30 Westbound

9/15/2013

Intersection: 6: Speen St & Cochituate Rd

Movement	EB	EB	EB	EB	WB	WB	WB	WB	NB	NB	NB	NB
Directions Served	L	T	TR	R	L	T	T	TR	L	L	T	TR
Maximum Queue (ft)	220	328	392	325	221	158	175	216	353	475	688	601
Average Queue (ft)	127	172	188	122	125	63	102	113	219	345	428	402
95th Queue (ft)	212	261	282	231	205	115	154	180	333	521	602	576
Link Distance (ft)		654	654			272	272	272			2084	2084
Upstream Blk Time (%)												
Queuing Penalty (veh)												
Storage Bay Dist (ft)	300			300	300				450	450		
Storage Blk Time (%)		0	1	0						0	7	
Queuing Penalty (veh)		1	3	0						0	41	

Intersection: 6: Speen St & Cochituate Rd

Movement	SB	SB	SB	SB
Directions Served	L	T	T	R
Maximum Queue (ft)	174	259	252	292
Average Queue (ft)	101	130	130	119
95th Queue (ft)	171	208	205	204
Link Distance (ft)		446	446	
Upstream Blk Time (%)				
Queuing Penalty (veh)				
Storage Bay Dist (ft)	150			300
Storage Blk Time (%)	1	9		0
Queuing Penalty (veh)	1	10		0

---

6: Speen St & Cochituate Rd Performance by approach

---

Approach	EB	WB	NB	SB	All
Denied Del/Veh (s)	0.0	0.0	32.2	0.0	9.0
Total Del/Veh (s)	29.6	40.1	179.7	136.8	94.1

Queuing and Blocking Report  
 3rd Lane Route 30 Westbound

9/15/2013

Intersection: 6: Speen St & Cochituate Rd

Movement	EB	EB	EB	EB	WB	WB	WB	WB	NB	NB	NB	NB
Directions Served	L	T	TR	R	L	T	T	TR	L	L	T	TR
Maximum Queue (ft)	323	339	290	290	225	334	276	284	462	475	1746	1722
Average Queue (ft)	76	202	190	187	194	200	162	167	425	442	1273	1224
95th Queue (ft)	164	292	267	267	249	344	230	243	547	554	2315	2273
Link Distance (ft)		681	681			272	272	272			1683	1683
Upstream Blk Time (%)						15	0	0			37	15
Queuing Penalty (veh)						55	1	1			0	0
Storage Bay Dist (ft)	300			300	200				450	450		
Storage Blk Time (%)	0	1	0	0	26	1			10	40	2	
Queuing Penalty (veh)	0	1	0	0	65	4			19	73	16	

Intersection: 6: Speen St & Cochituate Rd

Movement	SB	SB	SB	SB	B49
Directions Served	L	T	T	R	T
Maximum Queue (ft)	174	773	796	325	1268
Average Queue (ft)	78	273	771	325	1136
95th Queue (ft)	174	626	803	325	1659
Link Distance (ft)		706	706		1216
Upstream Blk Time (%)			63		63
Queuing Penalty (veh)			0		0
Storage Bay Dist (ft)	150			300	
Storage Blk Time (%)	0	13	0	83	
Queuing Penalty (veh)	0	13	1	230	

---

6: Speen St & Cochituate Rd Performance by approach

---

Approach	EB	WB	NB	SB	All
Denied Del/Veh (s)	0.0	0.0	0.9	0.0	0.3
Total Del/Veh (s)	22.7	40.7	72.6	44.5	46.5



Queuing and Blocking Report  
 3rd Lane on Route 30 Westbound Optimized

9/15/2013

Intersection: 6: Speen St & Cochituate Rd

Movement	EB	EB	EB	EB	WB	WB	WB	WB	NB	NB	NB	NB
Directions Served	L	T	TR	R	L	T	T	TR	L	L	T	TR
Maximum Queue (ft)	308	284	264	203	235	161	182	238	447	475	814	748
Average Queue (ft)	142	150	166	116	122	70	99	113	235	322	397	382
95th Queue (ft)	237	223	236	175	205	135	151	197	390	492	669	621
Link Distance (ft)		654	654			272	272	272			2084	2084
Upstream Blk Time (%)												
Queuing Penalty (veh)												
Storage Bay Dist (ft)	300			300	300				450	450		
Storage Blk Time (%)	0	0							0	0	7	
Queuing Penalty (veh)	1	0							0	1	41	

Intersection: 6: Speen St & Cochituate Rd

Movement	SB	SB	SB	SB
Directions Served	L	T	T	R
Maximum Queue (ft)	158	158	205	234
Average Queue (ft)	80	112	118	126
95th Queue (ft)	137	158	168	193
Link Distance (ft)		446	446	
Upstream Blk Time (%)				
Queuing Penalty (veh)				
Storage Bay Dist (ft)	150			300
Storage Blk Time (%)	0	2		
Queuing Penalty (veh)	0	2		

---

6: Speen St & Cochituate Rd Performance by approach

---

Approach	EB	WB	NB	SB	All
Denied Del/Veh (s)	0.0	0.0	2.1	0.0	0.6
Total Del/Veh (s)	26.3	38.7	166.2	120.1	88.4

Queuing and Blocking Report  
 3rd Lane Route 30 Westbound--Optimized

9/15/2013

Intersection: 6: Speen St & Cochituate Rd

Movement	EB	EB	EB	EB	WB	WB	WB	WB	NB	NB	NB	NB
Directions Served	L	T	TR	R	L	T	T	TR	L	L	T	TR
Maximum Queue (ft)	114	248	261	279	225	327	240	259	462	475	1722	1698
Average Queue (ft)	47	182	182	192	190	175	167	181	444	461	1212	1095
95th Queue (ft)	89	248	240	257	252	307	229	250	534	533	2174	2089
Link Distance (ft)		681	681			272	272	272			1683	1683
Upstream Blk Time (%)						4		0			14	3
Queuing Penalty (veh)						14		0			0	0
Storage Bay Dist (ft)	300			300	200				450	450		
Storage Blk Time (%)					16	1			14	46	1	
Queuing Penalty (veh)					41	2			27	86	11	

Intersection: 6: Speen St & Cochituate Rd

Movement	SB	SB	SB	SB	B49
Directions Served	L	T	T	R	T
Maximum Queue (ft)	175	774	814	325	1268
Average Queue (ft)	128	298	748	325	879
95th Queue (ft)	218	564	872	325	1653
Link Distance (ft)		706	706		1216
Upstream Blk Time (%)			50		30
Queuing Penalty (veh)			0		0
Storage Bay Dist (ft)	150			300	
Storage Blk Time (%)	3	35	1	75	
Queuing Penalty (veh)	8	34	4	209	

# **Cochituate Rail Trail Crossing Analysis**

# HCM Signalized Intersection Capacity Analysis

## 6: Speen St & Cochituate Rd

9/16/2013



Movement	EBL	EBT	EBR	WBL	WBT	WBR	NBL	NBT	NBR	SBL	SBT	SBR
Lane Configurations												
Volume (vph)	285	920	930	150	320	70	580	495	370	105	335	240
Ideal Flow (vphpl)	1900	1900	1900	1900	1900	1900	1900	1900	1900	1900	1900	1900
Total Lost time (s)	5.5	5.5	5.5	5.5	5.5		5.5	6.0		5.5	6.0	6.0
Lane Util. Factor	1.00	0.91	0.91	1.00	0.95		0.97	0.95		1.00	0.95	1.00
Frt	1.00	0.98	0.85	1.00	0.97		1.00	0.94		1.00	1.00	0.85
Flt Protected	0.95	1.00	1.00	0.95	1.00		0.95	1.00		0.95	1.00	1.00
Satd. Flow (prot)	1770	3323	1441	1770	3444		3433	3312		1770	3539	1583
Flt Permitted	0.95	1.00	1.00	0.95	1.00		0.95	1.00		0.95	1.00	1.00
Satd. Flow (perm)	1770	3323	1441	1770	3444		3433	3312		1770	3539	1583
Peak-hour factor, PHF	0.96	0.96	0.96	0.96	0.96	0.96	0.96	0.96	0.96	0.96	0.96	0.96
Adj. Flow (vph)	297	958	969	156	333	73	604	516	385	109	349	250
RTOR Reduction (vph)	0	7	251	0	11	0	0	82	0	0	0	178
Lane Group Flow (vph)	297	1096	573	156	395	0	604	819	0	109	349	72
Turn Type	Prot	NA	pt+ov	Prot	NA		Prot	NA		Prot	NA	pt+ov
Protected Phases	5	2	2 7	1	6		7	4		3	8	8 5
Permitted Phases												
Actuated Green, G (s)	28.3	47.1	81.7	14.7	33.5		29.1	30.6		12.7	14.2	42.5
Effective Green, g (s)	28.3	47.1	81.7	14.7	33.5		29.1	30.6		12.7	14.2	42.5
Actuated g/C Ratio	0.19	0.32	0.56	0.10	0.23		0.20	0.21		0.09	0.10	0.29
Clearance Time (s)	5.5	5.5		5.5	5.5		5.5	6.0		5.5	6.0	
Vehicle Extension (s)	3.0	3.0		3.0	3.0		3.0	3.0		3.0	3.0	
Lane Grp Cap (vph)	340	1065	801	177	785		680	689		153	342	457
v/s Ratio Prot	c0.17	c0.33	0.40	0.09	0.11		c0.18	c0.25		0.06	0.10	0.05
v/s Ratio Perm												
v/c Ratio	0.87	1.03	0.72	0.88	0.50		0.89	1.19		0.71	1.02	0.16
Uniform Delay, d1	57.6	49.9	24.0	65.2	49.4		57.3	58.1		65.3	66.4	38.9
Progression Factor	1.00	1.00	1.00	1.00	1.00		1.00	1.00		1.00	1.00	1.00
Incremental Delay, d2	21.1	35.3	3.1	36.3	0.5		13.4	99.3		14.5	54.0	0.2
Delay (s)	78.7	85.2	27.1	101.6	50.0		70.7	157.4		79.8	120.3	39.0
Level of Service	E	F	C	F	D		E	F		E	F	D
Approach Delay (s)		62.8			64.3			122.6			85.4	
Approach LOS		E			E			F			F	

### Intersection Summary

HCM 2000 Control Delay	84.2	HCM 2000 Level of Service	F
HCM 2000 Volume to Capacity ratio	0.96		
Actuated Cycle Length (s)	146.9	Sum of lost time (s)	28.0
Intersection Capacity Utilization	93.8%	ICU Level of Service	F
Analysis Period (min)	15		
c Critical Lane Group			

# HCM Signalized Intersection Capacity Analysis

## 6: Speen St & Cochituate Rd

9/16/2013



Movement	EBL	EBT	EBR	WBL	WBT	WBR	NBL	NBT	NBR	SBL	SBT	SBR
Lane Configurations												
Volume (vph)	80	435	935	305	730	40	750	360	180	95	540	570
Ideal Flow (vphpl)	1900	1900	1900	1900	1900	1900	1900	1900	1900	1900	1900	1900
Total Lost time (s)	5.5	6.0	6.0	5.5	5.5		5.5	6.0		5.5	6.0	6.0
Lane Util. Factor	1.00	0.91	0.91	1.00	0.95		0.97	0.95		1.00	0.95	1.00
Frt	1.00	0.97	0.85	1.00	0.99		1.00	0.95		1.00	1.00	0.85
Flt Protected	0.95	1.00	1.00	0.95	1.00		0.95	1.00		0.95	1.00	1.00
Satd. Flow (prot)	1770	3279	1441	1770	3512		3433	3362		1770	3539	1583
Flt Permitted	0.95	1.00	1.00	0.95	1.00		0.95	1.00		0.95	1.00	1.00
Satd. Flow (perm)	1770	3279	1441	1770	3512		3433	3362		1770	3539	1583
Peak-hour factor, PHF	0.97	0.97	0.97	0.97	0.97	0.97	0.97	0.97	0.97	0.97	0.97	0.97
Adj. Flow (vph)	82	448	964	314	753	41	773	371	186	98	557	588
RTOR Reduction (vph)	0	13	230	0	2	0	0	35	0	0	0	232
Lane Group Flow (vph)	82	560	609	314	792	0	773	522	0	98	557	356
Turn Type	Prot	NA	pt+ov	Prot	NA		Prot	NA		Prot	NA	pt+ov
Protected Phases	5	2	2 7	1	6		7	4		3	8	8 5
Permitted Phases												
Actuated Green, G (s)	13.8	26.5	62.6	30.8	44.0		30.1	46.0		12.6	28.5	42.3
Effective Green, g (s)	13.8	26.5	62.6	30.8	44.0		30.1	46.0		12.6	28.5	42.3
Actuated g/C Ratio	0.09	0.17	0.40	0.19	0.28		0.19	0.29		0.08	0.18	0.27
Clearance Time (s)	5.5	6.0		5.5	5.5		5.5	6.0		5.5	6.0	
Vehicle Extension (s)	3.0	3.0		3.0	3.0		3.0	3.0		3.0	3.0	
Lane Grp Cap (vph)	154	548	569	344	975		652	976		140	636	422
v/s Ratio Prot	0.05	0.17	c0.42	c0.18	0.23		c0.23	0.16		0.06	c0.16	0.23
v/s Ratio Perm												
v/c Ratio	0.53	1.02	1.07	0.91	0.81		1.19	0.54		0.70	0.88	0.84
Uniform Delay, d1	69.2	66.0	47.9	62.5	53.3		64.2	47.2		71.1	63.2	54.9
Progression Factor	1.00	1.00	1.00	1.00	1.00		1.00	1.00		1.00	1.00	1.00
Incremental Delay, d2	3.5	43.9	58.0	27.5	5.2		98.5	0.6		14.2	12.8	14.3
Delay (s)	72.7	109.9	105.9	90.0	58.6		162.6	47.8		85.3	76.1	69.2
Level of Service	E	F	F	F	E		F	D		F	E	E
Approach Delay (s)		105.6			67.5			114.5			73.6	
Approach LOS		F			E			F			E	

### Intersection Summary

HCM 2000 Control Delay	92.1	HCM 2000 Level of Service	F
HCM 2000 Volume to Capacity ratio	0.94		
Actuated Cycle Length (s)	158.4	Sum of lost time (s)	29.0
Intersection Capacity Utilization	94.4%	ICU Level of Service	F
Analysis Period (min)	15		
c Critical Lane Group			



# HCM Signalized Intersection Capacity Analysis

## 7: Cochituate Rd & TJX Driveway

9/16/2013



Movement	EBL	EBT	WBT	WBR	SBL	SBR
Lane Configurations						
Volume (vph)	610	735	480	115	10	20
Ideal Flow (vphpl)	1900	1900	1900	1900	1900	1900
Total Lost time (s)	5.0	5.0	5.0	5.0	5.0	5.0
Lane Util. Factor	1.00	1.00	1.00	1.00	1.00	1.00
Frbp, ped/bikes	1.00	1.00	1.00	1.00	1.00	1.00
Flpb, ped/bikes	1.00	1.00	1.00	1.00	1.00	1.00
Frt	1.00	1.00	1.00	0.85	1.00	0.85
Flt Protected	0.95	1.00	1.00	1.00	0.95	1.00
Satd. Flow (prot)	1770	1863	1863	1583	1770	1583
Flt Permitted	0.21	1.00	1.00	1.00	0.95	1.00
Satd. Flow (perm)	394	1863	1863	1583	1770	1583
Peak-hour factor, PHF	0.92	0.92	0.92	0.92	0.92	0.92
Adj. Flow (vph)	663	799	522	125	11	22
RTOR Reduction (vph)	0	0	0	72	0	12
Lane Group Flow (vph)	663	799	522	53	11	10
Confl. Peds. (#/hr)						2
Turn Type	pm+pt	NA	NA	Perm	NA	pt+ov
Protected Phases	1	6	2		3	3 1
Permitted Phases	6			2		
Actuated Green, G (s)	64.1	64.1	28.7	28.7	2.2	37.6
Effective Green, g (s)	64.1	64.1	28.7	28.7	2.2	37.6
Actuated g/C Ratio	0.74	0.74	0.33	0.33	0.03	0.44
Clearance Time (s)	5.0	5.0	5.0	5.0	5.0	
Vehicle Extension (s)	3.0	3.0	3.0	3.0	3.0	
Lane Grp Cap (vph)	776	1382	618	525	45	688
v/s Ratio Prot	c0.30	0.43	0.28		c0.01	0.01
v/s Ratio Perm	c0.33			0.03		
v/c Ratio	0.85	0.58	0.84	0.10	0.24	0.01
Uniform Delay, d1	17.8	5.0	26.8	19.9	41.3	13.9
Progression Factor	1.00	1.00	1.00	1.00	1.00	1.00
Incremental Delay, d2	9.1	0.6	10.3	0.1	2.8	0.0
Delay (s)	26.9	5.6	37.1	20.0	44.1	13.9
Level of Service	C	A	D	C	D	B
Approach Delay (s)		15.3	33.8		24.0	
Approach LOS		B	C		C	

### Intersection Summary

HCM 2000 Control Delay	21.0	HCM 2000 Level of Service	C
HCM 2000 Volume to Capacity ratio	0.81		
Actuated Cycle Length (s)	86.4	Sum of lost time (s)	20.0
Intersection Capacity Utilization	76.6%	ICU Level of Service	D
Analysis Period (min)	15		

c Critical Lane Group

# HCM Signalized Intersection Capacity Analysis

## 7: Cochituate Rd & TJX Driveway

9/16/2013



Movement	EBL	EBT	WBT	WBR	SBL	SBR
Lane Configurations						
Volume (vph)	30	600	500	10	80	500
Ideal Flow (vphpl)	1900	1900	1400	1400	1900	1900
Total Lost time (s)	5.0	5.0	5.0	5.0	5.0	5.0
Lane Util. Factor	1.00	1.00	1.00	1.00	1.00	1.00
Frpb, ped/bikes	1.00	1.00	1.00	1.00	1.00	1.00
Flpb, ped/bikes	1.00	1.00	1.00	1.00	1.00	1.00
Frt	1.00	1.00	1.00	0.85	1.00	0.85
Flt Protected	0.95	1.00	1.00	1.00	0.95	1.00
Satd. Flow (prot)	1770	1863	1373	1167	1770	1583
Flt Permitted	0.26	1.00	1.00	1.00	0.95	1.00
Satd. Flow (perm)	490	1863	1373	1167	1770	1583
Peak-hour factor, PHF	0.95	0.95	0.95	0.95	0.95	0.95
Adj. Flow (vph)	32	632	526	11	84	526
RTOR Reduction (vph)	0	0	0	7	0	0
Lane Group Flow (vph)	32	632	526	4	84	526
Confl. Peds. (#/hr)						2
Turn Type	pm+pt	NA	NA	Perm	NA	pt+ov
Protected Phases	1	6	2		3	3 1
Permitted Phases	6			2		
Actuated Green, G (s)	51.2	51.2	29.7	29.7	6.1	27.6
Effective Green, g (s)	51.2	51.2	29.7	29.7	6.1	27.6
Actuated g/C Ratio	0.65	0.65	0.38	0.38	0.08	0.35
Clearance Time (s)	5.0	5.0	5.0	5.0	5.0	
Vehicle Extension (s)	3.0	3.0	3.0	3.0	3.0	
Lane Grp Cap (vph)	587	1212	518	440	137	555
v/s Ratio Prot	0.01	0.34	c0.38		0.05	c0.33
v/s Ratio Perm	0.02			0.00		
v/c Ratio	0.05	0.52	1.02	0.01	0.61	0.95
Uniform Delay, d1	12.0	7.3	24.5	15.3	35.2	24.8
Progression Factor	1.00	1.00	1.00	1.00	1.00	1.00
Incremental Delay, d2	0.0	0.4	43.5	0.0	7.9	25.5
Delay (s)	12.1	7.7	68.0	15.3	43.0	50.4
Level of Service	B	A	E	B	D	D
Approach Delay (s)		7.9	66.9		49.3	
Approach LOS		A	E		D	

### Intersection Summary

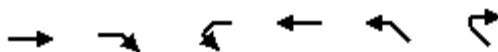
HCM 2000 Control Delay	39.4	HCM 2000 Level of Service	D
HCM 2000 Volume to Capacity ratio	0.96		
Actuated Cycle Length (s)	78.7	Sum of lost time (s)	20.0
Intersection Capacity Utilization	75.2%	ICU Level of Service	D
Analysis Period (min)	15		

c Critical Lane Group

# HCM Signalized Intersection Capacity Analysis

## 20: Home Depot Driveway & Cochituate Rd

9/16/2013



Movement	EBT	EBR	WBL	WBT	NWL	NWR
Lane Configurations	↑↑			↑↑	↑↑	
Volume (vph)	1345	50	10	500	40	25
Ideal Flow (vphpl)	1900	1900	1900	1900	1900	1900
Total Lost time (s)	6.0			6.0	6.0	
Lane Util. Factor	0.95			0.95	1.00	
Frbp, ped/bikes	1.00			1.00	0.96	
Flpb, ped/bikes	1.00			1.00	1.00	
Frt	0.99			1.00	0.95	
Flt Protected	1.00			1.00	0.97	
Satd. Flow (prot)	3506			3536	1638	
Flt Permitted	1.00			0.92	0.97	
Satd. Flow (perm)	3506			3242	1638	
Peak-hour factor, PHF	0.92	0.92	0.92	0.92	0.92	0.92
Adj. Flow (vph)	1462	54	11	543	43	27
RTOR Reduction (vph)	2	0	0	0	12	0
Lane Group Flow (vph)	1514	0	0	554	58	0
Confl. Peds. (#/hr)		50				50
Confl. Bikes (#/hr)		50				50
Turn Type	NA		Perm	NA	NA	
Protected Phases	2			6	4	
Permitted Phases			6	6		
Actuated Green, G (s)	43.3			43.3	11.4	
Effective Green, g (s)	43.3			43.3	11.4	
Actuated g/C Ratio	0.65			0.65	0.17	
Clearance Time (s)	6.0			6.0	6.0	
Vehicle Extension (s)	3.0			3.0	3.0	
Lane Grp Cap (vph)	2276			2104	279	
v/s Ratio Prot	c0.43				c0.04	
v/s Ratio Perm				0.17		
v/c Ratio	0.67			0.26	0.21	
Uniform Delay, d1	7.2			5.0	23.8	
Progression Factor	1.00			1.00	1.00	
Incremental Delay, d2	0.7			0.1	0.4	
Delay (s)	8.0			5.0	24.1	
Level of Service	A			A	C	
Approach Delay (s)	8.0			5.0	24.1	
Approach LOS	A			A	C	

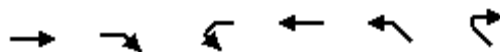
### Intersection Summary

HCM 2000 Control Delay	7.7	HCM 2000 Level of Service	A
HCM 2000 Volume to Capacity ratio	0.57		
Actuated Cycle Length (s)	66.7	Sum of lost time (s)	12.0
Intersection Capacity Utilization	66.1%	ICU Level of Service	C
Analysis Period (min)	15		
c Critical Lane Group			

# HCM Signalized Intersection Capacity Analysis

## 20: Home Depot Driveway & Cochituate Rd

9/16/2013



Movement	EBT	EBR	WBL	WBT	NWL	NWR
Lane Configurations	↑↑			↑↑	↑↑	
Volume (vph)	605	100	0	1000	60	25
Ideal Flow (vphpl)	1900	1900	1900	1900	1900	1900
Total Lost time (s)	6.0			6.0	6.0	
Lane Util. Factor	0.95			0.95	1.00	
Frt	0.98			1.00	0.96	
Flt Protected	1.00			1.00	0.97	
Satd. Flow (prot)	3464			3539	1728	
Flt Permitted	1.00			1.00	0.97	
Satd. Flow (perm)	3464			3539	1728	
Peak-hour factor, PHF	0.95	0.95	0.95	0.95	0.95	0.95
Adj. Flow (vph)	637	105	0	1053	63	26
RTOR Reduction (vph)	18	0	0	0	24	0
Lane Group Flow (vph)	724	0	0	1053	65	0
Turn Type	NA			NA	NA	
Protected Phases	4			8	2	
Permitted Phases						
Actuated Green, G (s)	19.1			19.1	2.9	
Effective Green, g (s)	19.1			19.1	2.9	
Actuated g/C Ratio	0.46			0.46	0.07	
Clearance Time (s)	6.0			6.0	6.0	
Vehicle Extension (s)	3.0			3.0	3.0	
Lane Grp Cap (vph)	1586			1620	120	
v/s Ratio Prot	0.21			c0.30	c0.04	
v/s Ratio Perm						
v/c Ratio	0.46			0.65	0.54	
Uniform Delay, d1	7.7			8.7	18.8	
Progression Factor	1.00			1.00	1.00	
Incremental Delay, d2	0.2			0.9	4.9	
Delay (s)	8.0			9.7	23.6	
Level of Service	A			A	C	
Approach Delay (s)	8.0			9.7	23.6	
Approach LOS	A			A	C	

### Intersection Summary

HCM 2000 Control Delay	9.6	HCM 2000 Level of Service	A
HCM 2000 Volume to Capacity ratio	0.59		
Actuated Cycle Length (s)	41.7	Sum of lost time (s)	18.0
Intersection Capacity Utilization	42.5%	ICU Level of Service	A
Analysis Period (min)	15		
c Critical Lane Group			



# **Appendix E: Mitigation Improvements and Actions for Route 30**

## FedEx Ground - Natick, MA Summary of Traffic Improvement Measures Discussed with the Planning Board, Town Staff and Peer Review Consultant

DRAFT

#	Location	Approximate Design & Construction Cost by Beta	Revised Approx. Design & Construction Cost by VHB	Maximum Increase in Hourly Traffic Volume	Improvement in Traffic Operations due to Suggested Mitigation	Scannell Responsibility	Town of Natick Responsibility
1	Route 30 / Route 27 (Wayland) - Contribution to the Town of Wayland - ASSUMED	\$10,000	\$25,000	1%	Monetary contribution to interim or long term improvements; project adds approx. 20 vehicles to the approx. 2,300+ vehicles during the peak hour.	Funding	None
2	Speen Street / Route 30 (Framingham)	\$55,000	\$145,000	3%	Intersection delay during AM peak hour reduced by 39 seconds per vehicle (LOS improves from F to E) when compared to the No-Build condition; delay during PM peak reduced by 26 seconds per vehicle; monetary contribution towards a planning study for long term improvements. All traffic through the intersection will benefit from these improvements.  The monetary contribution will be put into escrow and used by the applicant to construct the sidewalk upon receipt of the permits by the Town.	Design & Construction  Funding	None  Permitting / Securing rights-of-way
	Modify signal timings/controller settings	\$5,000	\$5,000				
	Contribution to planning study for long term improvements - ASSUMED	\$50,000	\$50,000				
	Sidewalk from Courtyard by Marriott to Route 30		\$90,000				
3	Speen Street Northbound / Route 9 WB Off-ramp - Install advance queue detector	\$35,000	\$42,000	2%	Advance detector would assist in addressing holiday period queue spillbacks onto Route 9 during peak shopping hours. Project traffic does not trigger the need for this detector.	Design & Construction	None
4	Speen Street / Chrysler Road - Modify signal timings/controller settings	\$5,000	\$5,000	2%	Mitigation at this location will improve vehicle progression between the intersections and help with queue management. Both site traffic as well as future residential traffic on Speen Street will benefit from this improvement.	Design & Construction	None
5	Speen Street / Nouvelle Way - Modify signal timings/controller settings	\$5,000	\$5,000	2%	Mitigation at this location will improve vehicle progression between the intersections and help with queue management. Both site traffic as well as future residential traffic on Speen Street will benefit from this improvement.	Design & Construction	None
6	Speen Street Southbound / Natick Mall Road	\$24,000	\$24,000	5%	Signal adjustments at this location will improve vehicle progression between the intersections and help with queue management. Both site traffic as well as future residential traffic on Speen Street will benefit from this improvement.  Pedestrian improvement will benefit all tenants on the east side of Speen Street by providing a safe, signalized crossing.	Design & Construction	None
	Modify signal timings/controller settings						
	Pedestrian crossing across Speen Street						
7	Speen Street Southbound / Superior Dr	\$6,000	\$23,000	6%	Improvement will help reduce current lane usage confusion noted by the Safety Officer and weaving conflicts in the southbound direction. Truck turning will be improved.	Design & Construction	None
	- Signage and Pavement Marking Improvement		\$8,000				
	- Geometric improvement to facilitate truck turning		\$15,000				



**FedEx Ground - Natick, MA Summary of Traffic Improvement Measures Discussed with the Planning Board,  
Town Staff and Peer Review Consultant (Cont.)**

#	Location	Approximate Design & Construction Cost by Beta	Revised Approx. Design & Construction Cost by VHB	Maximum Increase in Hourly Traffic Volume	Improvement in Traffic Operations due to Suggested Mitigation	Scannell Responsibility	Town of Natick Responsibility
8	Speen Street Northbound / Superior Dr				New geometry and state of the art traffic signal hardware offsets impact caused by Site traffic. Northbound vehicular queues reduced by 60+ feet during the morning peak hour and 20+ feet during the evening peak hour when compared to the No-Build condition. LOS is maintained at C. Sidewalk and crosswalk improvements will benefit all properties in the area. Change in the signal phasing would help reduce conflicts between eastbound and westbound turning traffic.	Design & Construction	None
	Geometric improvements including pedestrian crossings	\$350,000	\$350,000	9%			
	Upgrade traffic signal hardware						
	Modify signal phasing to implement a lead phase						
9	Reconstruct Superior Dr + sidewalk on the south side of the roadway	\$720,000	\$720,000	52%	Improvement will bring the easterly section of Superior Drive to town standards. Existing awkward geometry at the BSC gated entry will be improved by defining Superior Drive as the primary roadway and the driveways as the secondary/stop controlled approaches	Design & Construction	None
10	Speen St sidewalk between Superior Dr & Natick Mall Road	\$60,000	\$90,000	Minimal	Sidewalk will be constructed by the applicant. This will benefit all properties in the area by providing a pedestrian connection between the east and west sides of Speen Street.	Design & Construction	Securing rights-of-way
11	December Timing Plan for Speen Street between Route 30 and Superior Drive	\$35,000	\$35,000	Less than non-peak	This will help ease some of the congestion on Speen Street by prioritizing northbound and southbound through traffic over the side streets. The improvement would complement the Mall's Holiday Traffic Management Plan.	Design & Construction	None
12	Miscellaneous signage / pavement markings on the beetleback - ASSUMED	\$25,000	\$25,000	1%	Improvement will help reduce current confusion noted by the Safety Officer related to worn pavement markings and inadequate lane usage signs.	Design & Construction	None
13	Town design review & final inspection of field work	\$20,000	\$20,000	Not applicable	Cost of town's consultant services relative to review of off-site traffic improvement plans and inspections	Funding	None
	<b>TOTAL ORDER OF MAGNITUDE DESIGN &amp; CONSTRUCTION</b>	<b>\$1,350,000</b>	<b>\$1,509,000</b>				

C Includes an approximate allowance for design of the improvements

D Site traffic as a percentage of future traffic at the location (higher of the AM or PM peak hours); %s based on December projections for activity on the Site. Non-Holiday traffic impacts of the project would be less than those presented in the analysis.

**NOTE:** Improvements at locations under MassDOT jurisdiction are subject to their review and approval.

OFFICE FILE

**COPY**

**Lowe's of Framingham  
Potential Mitigation  
Measures**

**Submitted to:  
Town of Framingham  
Planning Board**

**February 1, 2005**

0-88

**Lowe's of Framingham**  
Mitigation Matrix (02/01/05)

Item #	Location	Description	Estimated Cost	Comments
1	Beacon Street/Route 30 Intersection	Upgrade traffic signal equipment; upgrade sidewalks to ADA standards; install signal conduit.	\$205,000	By Lowe's
		Survey and design.	\$45,000	By Lowe's
2	Route 9/Route 30 Intersection	Realign Route 30 approach to Route 9. Reconstruct driveways.	\$140,000	By Lowe's
		Survey, design and permitting.	\$25,000	By Lowe's
3	Route 30 - Adjacent to project site	Cold plane and resurface.	\$65,000	By Lowe's
X	Route 30 - Project site to east end of Route 126/ Route 30 intersection project	Cold plane and resurface.		<i>Deleted</i>
5	Route 126/Hardy Street Intersection	<i>Contribution to construction of a more aesthetically pleasing street closure.</i>	\$15,000	By Lowe's
6	Route 30 - Route 126 to Route 9	Upgrade pavement markings with thermoplastic markings.	\$11,000	By Lowe's
7	Route 30 - Just east of Route 126	Plant approximately 20 trees in median. Loam and seed.	\$40,000	By Lowe's
8	Route 30/N-S Connector Intersection	Rebuild crosswalk and add pedestrian signal heads.	\$25,000	By Lowe's
9	Town-wide	<i>Contribution to TMA for public transportation purposes.</i>	\$35,000	By Lowe's
10	Route 30 - Whittier Street to Caldor Road	Upgrade 1,800 ft of raised median. Replace sloped granite curbing with vertical granite. Replace asphalt with concrete in median.	\$90,000	By Lowe's
		<b>Subtotal (Off-site Traffic)</b>	<b>\$696,000</b>	
11	Route 30 - Site to Caldor Road	Upgrade 1,100 lf of water main from 6" to 12".	\$240,000	By Lowe's
12	Stop & Shop Property	Add lighted bollards, landscaping and irrigation system or deep soils.	\$25,000	By Lowe's
		<b>Subtotal (Off-site non-Traffic)</b>	<b>\$265,000</b>	
		<b>TOTAL Lowe's Off-site Contribution</b>	<b>\$961,000</b>	
13	Route 30/N-S Connector Intersection	Modify signal phasing and timing.	\$10,000	By Lowe's
14	Route 30 at Connector Road	Provide bus shelter on Route 30 at project site.	\$10,000	By Lowe's
15	Cochituate Rail Trail	Provide funding for project development.	\$2,000	By Lowe's
16	Route 30 - Whittier Street to Site	Upgrade 700 lf of water main from 6" to 12".	\$150,000	By Lowe's
		<b>TOTAL- Other Actions Not Counting Towards 6% Limit</b>	<b>\$172,000</b>	

Changes since 1/25/05 matrix shown in italics.

**Figure 2**



**Lowe's of Framingham**  
Description of Updates for 02/01/05 Matrix

Item #	Location	Description of Change or Reason for Change
1	Beacon Street/Route 30 Intersection	No change
		No change
2	Route 9/Route 30 Intersection	No change
		No change
3	Route 30 - Adjacent to project site	No change
4	Route 30 - Project site to east end of Route 126/ Route 30 intersection project	Deleted as discussed at 1/25/05 PB Hearing. Jay to consult w/DPW and confirm change.
5	Route 126/Hardy Street Intersection	Lowe's obligation reduced to a contribution rather than 100% responsibility as discussed at 1/25/05 PB Hearing.
6	Route 30 - Route 126 to Route 9	No change
7	Route 30 - Just east of Route 126	Lowe's agreed to fund this improvement at 1/25/05 PB hearing after Jay confirmed that there are no DPW funds available for this improvement.
8	Route 30/N-S Connector Intersection	Rebuild crosswalk and add pedestrian signal heads
9	Town-wide	Description changed recognizing that Lowe's cannot make a direct contribution to LIFT based on discussion at 1/25/05 PB hearing.
10	Route 30 - Whittier Street to Caldor Road	Rizzo corrected typo. Project limit extends to Caldor Road not the Site as listed previously.
11	Route 30 - Site to Caldor Road	Cost estimate increased to include resetting existing sloped granite curb and asphalt (omitted from earlier estimate).
12	Stop & Shop Property	No change
13	Route 30/N-S Connector Intersection	No change
14	Route 30 at Connector Road	No change
15	Cochituate Rail Trail	No change
16	Route 30 - Whittier Street to Site	Cost estimate increased to include resetting existing sloped granite curb and asphalt (omitted from earlier estimate).

**Figure 3**

## Item #11 Route 30 Water Line – Site to Caldor Road

**Purpose:** Increase the capacity of the existing water line located in Route 30.

**Scope:** Replace the existing 6-inch water main located within the Route 30 median with a 12-inch water main in the same location as the existing line. Length of project is approximately 1,100 feet.

- Temporary bypass to be provided during construction.
- Adjacent sewer line to be video inspected before and after construction. Post construction inspection must be done before the contractor has left the site.
- Sewer line to be cleaned during first inspection (pipe was recently cleaned).
- Median islands must be reconstructed to meet ADA standards if necessary at Route 30 crosswalks.
- Overlay will not be required except adjacent to the project site. (See Item # 3 above).
- Specifications to be submitted to the Town for review prior to bidding the job.
- Pressure test will be conducted by a third party at applicant's expense.
- Bypass to be chlorinated and tested prior to being put into service.
- All hydrants, laterals and gates to be replaced with new.
- Curbing and asphalt median materials to be replaced consistent with Item #10 above.

**Cost:** Construction: \$240,000

**Comments:** Cost estimate attached. This work is not required to provide adequate water supply and pressure at the site.

# ITEM #11

PROJECT NAME: Replace 6" water line w/12" water line, (Site to Caldor Road-1100 Feet)  
 PROJECT NUMBER: 9689  
 PRELIMINARY COST ESTIMATE

DATE: 21-Jan-05

Description:	Quantity		Unit Cost	Total
Sawcut Bit. Concrete	1,100	LF	\$3.00	\$3,300
Trench Excavation	1,589	CY	\$25.00	\$39,722
Bedding	41	CY	\$50.00	\$2,037
Remove and Dispose Existing Pipe	1,100	LF	\$5.00	\$5,500
Install 12" CLDI Pipe	1,100	LF	\$40.00	\$44,000
Backfill	1,589	CY	\$15.00	\$23,833
Trench Repair	82	Ton	\$100	\$8,200
Median reconstruction	61% (1100/1800 feet) of \$64,160 (see Item #10)			\$39,138
12" Valves and Fittings	10	EA	\$800	\$8,000
Test and Disinfect	1	LS	\$5,000	\$5,000
Temporary 8" PVC Service	1,100	LF	\$25	\$27,500
Temporary Services	4	EA	\$200	\$800
Police Detail	10	Days	\$350	\$3,500
<b>Water line Replacement Subtotal</b>				<b>\$207,031</b>
Contingency at 15%				\$31,055
<b>Total</b>				<b>\$238,085</b>
SAY				\$240,000



## Item #16 Route 30 – Whittier Street to Site

**Purpose:** Increase the capacity of the existing water line located in Route 30 to meet the water needs of the proposed project.

**Scope:** Replace the existing 6-inch water main located within the Route 30 median with a 12-inch water main in the same location as the existing line. Length of project is approximately 700 feet.

- Temporary bypass to be provided during construction.
- Adjacent sewer line to be video inspected before and after construction. Post construction inspection must be done before the contractor has left the site.
- Sewer line to be cleaned during first inspection (pipe was recently cleaned).
- Median islands must be reconstructed to meet ADA standards if necessary at Route 30 crosswalks.
- Overlay will not be required except adjacent to the project site. (See Item # 3 above).
- Specifications to be submitted to the Town for review prior to bidding the job.
- Pressure test will be conducted by a third party at applicant's expense.
- Bypass to be chlorinated and tested prior to being put into service.
- All hydrants, laterals and gates to be replaced with new.
- Curbing and asphalt median materials to be replaced consistent with Item #10 above.

**Cost:** Construction: \$150,000

**Comments:** Cost estimate attached.



# ITEM #16

PROJECT NAME: Replace 6" water line w/12" water line, (Whittier St to Site-700 Feet)  
 PROJECT NUMBER: 9689  
 PRELIMINARY COST ESTIMATE

DATE: 21-Jan-05

Description:	Quantity		Unit Cost	Total
Sawcut Bit. Concrete	700	LF	\$3.00	\$2,100
Trench Excavation	1,011	CY	\$25.00	\$25,278
Bedding	26	CY	\$40.00	\$1,037
Remove and Dispose Existing Pipe	700	LF	\$5.00	\$3,500
Install 12" CLDI Pipe	700	LF	\$40.00	\$28,000
Backfill	1,011	CY	\$15.00	\$15,167
Trench Repair	53	Ton	\$100	\$5,300
Median reconstruction	39% (700/1800 feet) of \$64,160 (see Item #10)			\$25,022
12" Valves and Fittings	5	EA	\$800	\$4,000
Test and Disinfect	1	LS	\$5,000	\$5,000
Temporary 8" PVC Service	700	LF	\$25	\$17,500
Temporary Services	1	EA	\$200	\$200
Police Detail	4	Days	\$350	\$1,400
Water line Replacement Subtotal				\$132,103
Contingency at 15%				\$19,816
Total				\$151,919
SAY				\$150,000



Legend	
	Pavement Markings
	Water Line Improvements
	Intersection Improvements
	Bus/Transit Shelter
	Roadway Resurfacing
	Financial Contribution
	Landscape Improvements
	Curb Improvements



RIZZO ASSOCIATES  
A TETRA TECH COMPANY

Lowe's Companies, Inc.  
Framingham, Massachusetts

Potential Mitigation Actions

Figure 1



## **Appendix F: Trail User Counts on Various Trails in Massachusetts**

**Table 1 Counts Done on Various Trails across Massachusetts, Two-Way Volumes, All Users**

Saturday, Sept 8, 2007

for hour beginning at:

Trail	7:00 AM	8:00 AM	9:00 AM	10:00 AM	11:00 AM	noon	1:00 PM	2:00 PM	3:00 PM	4:00 PM	5:00 PM	6:00 PM	avg. vol. per hour**
<b>Manhan Rail Trail</b> Easthampton, Union-Payson	18	49	61	46	65	49	40	58	44	33	13	43	43
<b>City of Northampton Bikeway</b>	33	35	68						45	59	42	14	40
<b>Norwottuck Rail Trail</b>	32	38	60	77	98	84	129	93	83	88	42	55	73
<b>Nashua River Rail Trail</b> Ayer, Groton St.				54	57								56
<b>Nashua River Rail Trail*</b> Groton @ Station Ave.	40	77	403	238	93	60	42	41	37	70	18	3	94
<b>Nashua River Rail Trail</b> Pepperell Center	39	84	111	112	92	92	42	45					77
<b>Upper Charles Trail</b> Milford @ Louisa Lake	22	45	65	85	55	38	51	33	41	119	50	47	54
<b>Upper Charles Trail</b> Milford @ Fino Field	26	44	60	54	47	31	31	56	25	70	43	54	45
<b>Minuteman Commuter Bikeway</b> Lexington @ depot	170	262	298	291	270	264	207	155	161	162	157	53	204
<b>Minuteman Commuter Bikeway</b> Lexington @ Camellia Place							142	149					146
<b>Minuteman Commuter Bikeway</b> Arlington @ Park Avenue			337	295									316
<b>Dr. Paul Dudley White Path</b> Cambridge, 300' east of Mass Ave	118	217	285	270	209	148	127	132	90	95	144	139	165
<b>Shining Sea</b> Falmouth								84	111	75			90
<b>Beach Road, Edgartown</b> near Blue Heron Way				33	21	61	56						43

*sunny, hot, humid, high of 96F, some scattered thunderstorms in the late afternoon or early evening*

\*The counts on the Nashua River Rail Trail are unusually high from 9 to 11 AM due to a charity event.

\*\*The average hourly volumes for trails with 12-hour counts are in larger type.

For further information, contact Cathy Buckley Lewis, Boston Metropolitan Planning Organization staff, [cathy@ctps.org](mailto:cathy@ctps.org), 617-973-7118.

**Table 2 Percentage of Users by Category, Various Trails across Massachusetts**

Saturday, Sept 8, 2007		Share of Users by Mode of Travel (%)								
Trail	Total Volume	Baby Carriage	Bicyclist	Jogger	Skater	Walker	Wheelchair User	Other	Total*	Walking with dogs**
Manhan Rail Trail Easthampton, Union-Payson	519	1	54	4	5	33	0	3	100	
City of Northampton Bikeway	341	2	42	7	2	47	1	0	101	
Norwottuck Rail Trail	879	1	74	4	1	19	0	0	99	
Nashua River Rail Trail Ayer, Groton St.	117	0	76	1	8	15	0	0	100	33%
Nashua River Rail Trail Groton @ Station Ave.	1,122	3	44	16	3	33	0	1	100	
Nashua River Rail Trail Pepperell Center	617	1	79	3	3	13	1	1	101	
Upper Charles Trail Milford @ Louisa Lake	651	4	41	4	2	48	0	1	100	13%
Upper Charles Trail Milford @ Fino Field	541	3	54	4	1	36	0	2	100	19%
Minuteman Commuter Bikeway Lexington @ depot	2,450	1	71	11	5	11	0	0	99	
Minuteman Commuter Bikeway Lexington @ Camellia Place	291	0	82	3	10	4	0	0	99	
Minuteman Commuter Bikeway Arlington @ Park Avenue	632	1	60	24	2	13	0	0	100	
Dr. Paul Dudley White Path Cambridge, 300' east of Mass Ave	1,975	1	25	51	1	22	0	0	100	
Shining Sea Falmouth	280	0	76	1	5	17	0	1	100	
Beach Road, Edgartown near Blue Heron Way	171	0	92	5	1	2	0	0	100	

*sunny, hot, humid, high of 96F, some scattered thunderstorms in the late afternoon or early evening*

\* Total may not equal 100% due to rounding.

\*\* Indicates the percentage of the pedestrians who were walking dogs, if data available.

For further information, contact Cathy Buckley Lewis, Boston Metropolitan Planning Organization staff, [cathy@ctps.org](mailto:cathy@ctps.org), 617-973-7118.

**Table 3 Counts of Trail Users, by Type of User, for Selected Trails, Saturday, September 8, 2007**

<b>Trail</b>	<b>Baby Carriage</b>	<b>Bicyclist</b>	<b>Jogger</b>	<b>Skater</b>	<b>Walker</b>	<b>Wheelchair</b>	<b>Other</b>	<b>Total</b>	<b>Hours Counted</b>
<b>Manhan Rail Trail</b> Easthampton, Union-Payson	6	278	22	27	170	0	16	<b>519</b>	<b>12</b>
<b>City of Northampton Bikeway</b>	7	142	25	6	130	2	29	<b>341</b>	<b>8</b>
<b>Norwottuck Rail Trail</b>	9	654	38	10	165	3	0	<b>879</b>	<b>12</b>
<b>Nashua River Rail Trail</b> Ayer, Groton St.	0	89	1	9	18	0	0	<b>117</b>	<b>2</b>
<b>Nashua River Rail Trail</b> Groton @ Station Ave.	39	489	183	35	366	1	9	<b>1,122</b>	<b>12</b>
<b>Nashua River Rail Trail</b> Pepperell Center	4	485	17	17	83	5	6	<b>617</b>	<b>8</b>
<b>Upper Charles Trail</b> Milford @ Louisa Lake	23	269	26	12	312	0	9	<b>651</b>	<b>10</b>
<b>Upper Charles Trail</b> Milford @ Fino Field	17	290	20	8	197	0	9	<b>541</b>	<b>10</b>
<b>Minuteman Commuter Bikeway</b> Bedford, Wiggins Ave-South Rd		113	1	5	2				45 min
<b>Minuteman Commuter Bikeway</b> Lexington @ depot	24	1740	264	130	281	0	11	<b>2,450</b>	<b>12</b>
<b>Minuteman Commuter Bikeway</b> Lexington @ Camellia Place	0	240	8	30	13	0	0	<b>291</b>	
<b>Minuteman Commuter Bikeway</b> Arlington @ Park Avenue	9	377	149	12	85	0	0	<b>632</b>	<b>2</b>
<b>Dr. Paul Dudley White Path</b> Cambridge, 300' east of Mass Ave	12	492	1016	10	442	0	3	<b>1,975</b>	<b>12</b>
<b>Shining Sea</b> Falmouth	1	212	4	14	47	0	2	<b>280</b>	<b>2,+15 min</b>
<b>Beach Road, Edgartown</b> near Blue Heron Way	0	158	8	1	4	0	0	<b>171</b>	<b>4</b>
<b>Total</b>	<b>151</b>	<b>6,028</b>	<b>1,782</b>	<b>326</b>	<b>2,315</b>	<b>11</b>	<b>94</b>	<b>10,586</b>	
<b>Average</b> <i>using data from all trail counts</i>	<b>1%</b>	<b>57%</b>	<b>17%</b>	<b>3%</b>	<b>22%</b>	<b>0%</b>	<b>1%</b>	<b>101%</b>	

For further information, contact Cathy Buckley Lewis, Boston Metropolitan Planning Organization staff, cathy@ctps.org, 617-973-7118.



**Table 4 User Counts, Two Locations, Upper Charles Trail, Milford, Massachusetts, Various Dates, 2007**

**Two-Way Volumes, All Users**

for hour beginning at:	7:00 AM	8:00 AM	9:00 AM	10:00 AM	11:00 AM	noon	1:00 PM	2:00 PM	3:00 PM	4:00 PM	5:00 PM	6:00 PM	avg. vol. per hour
------------------------	---------	---------	---------	----------	----------	------	---------	---------	---------	---------	---------	---------	--------------------

**Upper Charles Trail, 2007**

**Saturday, Sept 8** *sunny, hot, humid, high of 96F, some scattered thunderstorms in the late afternoon or early evening*

Louisa Lake	22	45	65	85	55	38	51	33	41	119	50	47	54
Fino Field	26	44	60	54	47	31	31	56	25	70	43	54	45

**Sunday, Sept 9** *heavy overcast, low 70's, threat of showers all day*

Louisa Lake		26	50	44	71	88	25	41	90	66	63		56
-------------	--	----	----	----	----	----	----	----	----	----	----	--	----

**Saturday, Oct 13**

Louisa Lake			38	52	67		114	127	103				84
Fino Field			33	23	23		75	77	43				46

**Sunday, Oct 14**

Louisa Lake			39	67	145		147	98	94				98
Fino Field			21	58	76		82	77	54				61

**Minuteman Commuter Bikeway, Lexington, 1997 & 2007**

**Tuesday, June 17, 1997**

Bow Street	120	122	91	135	136	128	100	108	122	136	263	390	154
------------	-----	-----	----	-----	-----	-----	-----	-----	-----	-----	-----	-----	-----

**Saturday, Sept 8, 2007**

Depot Street	170	262	298	291	270	264	207	155	161	162	157	53	204
--------------	-----	-----	-----	-----	-----	-----	-----	-----	-----	-----	-----	----	-----

For further information, contact Cathy Buckley Lewis, Boston Metropolitan Planning Organization staff, [cathy@ctps.org](mailto:cathy@ctps.org), 617-973-7118.